

Microwave Semiconductors

GaAs and Silicon Products

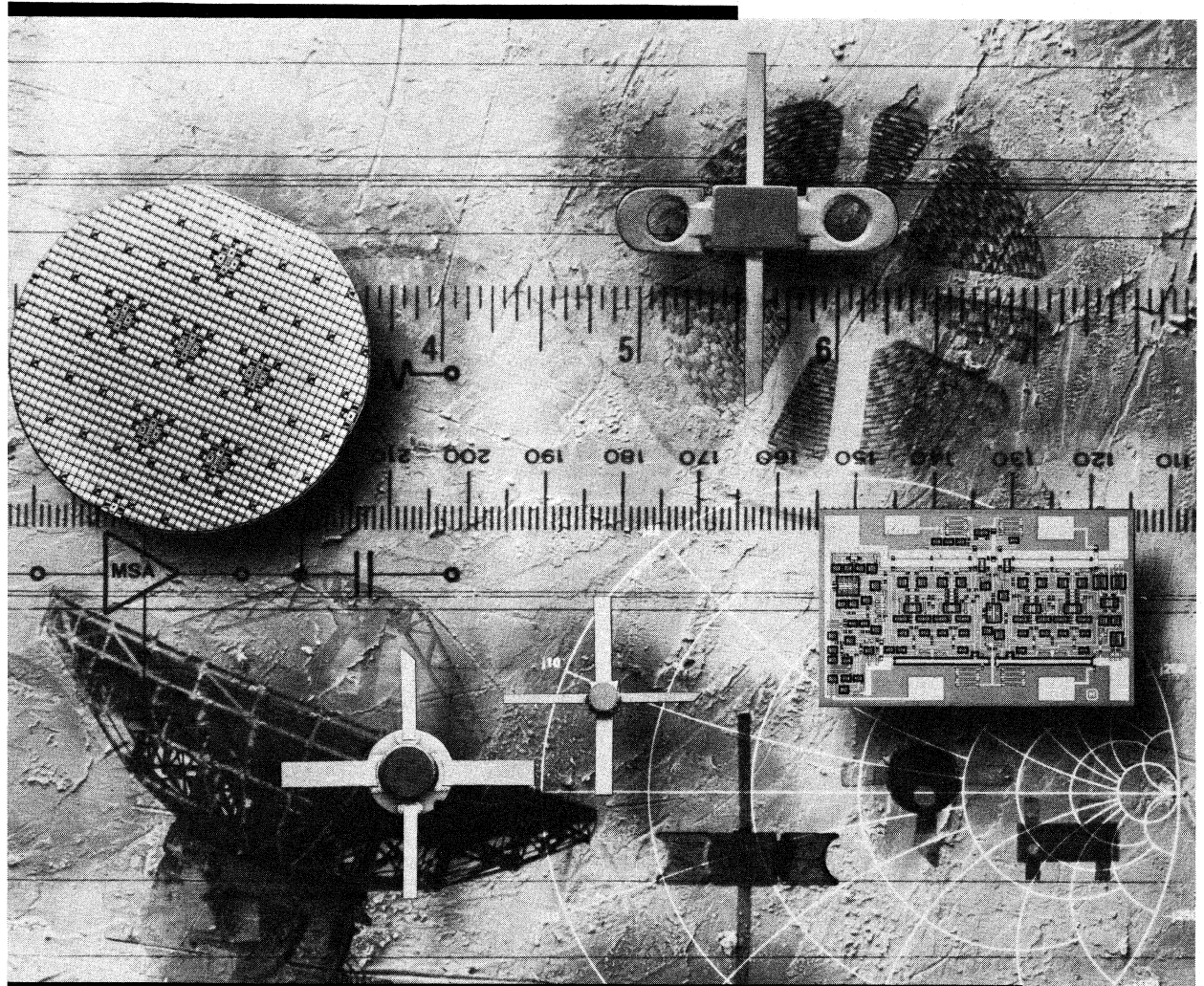

Data Book

Avantek, Inc. reserves the right to make changes to the products described in this catalog to improve performance, reliability or manufacturability at any time without notice. Changes and additions made after the publication of this catalog will be reflected in updated product data sheets or other literature as soon as possible.

Avantek, Inc., recommends that before the products described herein are written into specifications or used in critical applications that the performance characteristics be verified by contacting any authorized Avantek distributor, representative or the factory.

Every effort has been made to ensure the accuracy of the information contained in this Data Book to factory specifications on June 15, 1989, however Avantek, Inc. assumes no responsibility for errors, omissions or future specification changes as described above.

Unless otherwise indicated, all specifications indicated as minimum or maximum are guaranteed at the temperatures and under the conditions described. All specifications indicated as typical are tested on a periodic basis and are intended to provide a good indication of actual performance, but are not guaranteed. FOR MORE DETAILED INFORMATION ON ANY PRODUCT, CONTACT ANY AUTHORIZED AVANTEK DISTRIBUTOR, REPRESENTATIVE OR THE FACTORY.

The following are trademarks of Avantek, Inc.

 AVANTEK®

MiCamp®

UNIT®

PlanarPak™

Avanpak™

MODAMP™

IMFET™

MagIC™

Some Avantek products are manufactured under the following U.S. patents:
3809817, 3931472, 3978282, Re. 29844, 4595881, 4649354, 4672023.

Copyright 1989, Avantek, Inc.

TABLE OF CONTENTS and ALPHANUMERIC INDEX**INTRODUCTION****SILICON BIPOLAR TRANSISTORS****GALLIUM ARSENIDE FETs****SILICON MONOLITHIC MICROWAVE INTEGRATED CIRCUITS****GALLIUM ARSENIDE MONOLITHIC MICROWAVE INTEGRATED CIRCUITS****APPLICATION INFORMATION****MEASUREMENTS****DEVICE MODELING****PACKAGING****HIGH RELIABILITY SCREENING****QUALITY ASSURANCE, WARRANTY, and ORDERING INFORMATION**

CONTENTS (Tab Identifiers)	iii
ALPHANUMERIC INDEX	vi
INTRODUCTION	
• SOME INFORMATION ABOUT THIS DATA BOOK	1-2
• AVANTEK VERTICAL INTEGRATION	1-3
• 24 YEAR HISTORY	1-6
• OTHER COMPANY PRODUCTS	1-7
MICROWAVE SILICON BIPOLAR TRANSISTORS	
• SILICON BIPOLAR TRANSISTOR SELECTION GUIDE	2-2
• AT-SERIES BIPOLAR TRANSISTORS	2-4
GALLIUM ARSENIDE FETs	
• GaAs FET SELECTION GUIDE	3-2
• ATF-SERIES FETs	3-6
SILICON MONOLITHIC MICROWAVE INTEGRATED CIRCUITS	
• SILICON MMIC SELECTION GUIDE	4-2
• MagIC™ IAM-SERIES ACTIVE MIXERS	4-6
• MagIC IFD-SERIES PRESCALERS	4-10
• MagIC INA-SERIES LOW NOISE AMPLIFIERS	4-14
• MagIC IVA-SERIES VARIABLE GAIN CONTROL AMPLIFIERS	4-20
• MODAMP™ MSA-SERIES AMPLIFIERS	4-22
• MSF-SERIES FREQUENCY CONVERTERS	4-26
GALLIUM ARSENIDE MONOLITHIC MICROWAVE INTEGRATED CIRCUITS	
• GaAs MMIC SELECTION GUIDE	5-2
• MGA-SERIES PRODUCTS	5-3

APPLICATION INFORMATION

- SERVICES 6-2
- LITERATURE 6-2
- APPLICATION NOTE EXTRACTS 6-3
 - ELECTROSTATIC DISCHARGE DAMAGE AND CONTROL 6-3
 - MOUNTING CONSIDERATIONS FOR PACKAGED MICROWAVE SEMICONDUCTORS 6-4
 - TRANSISTOR CHIP USE 6-6
 - MODAMP SILICON MMIC CHIP USE 6-8
 - BIASING MODAMP MMICs 6-10

MEASUREMENTS

- S-PARAMETERS 7-2
- NOISE PARAMETERS 7-3
- POWER PARAMETERS 7-6
- THERMAL RESISTANCE 7-6

DEVICE MODELING 8-2**PACKAGING**

- PACKAGE OUTLINE DRAWINGS 9-2
- TAPE-AND-REEL PACKAGING FOR SURFACE MOUNT SEMICONDUCTORS 9-7

HIGH RELIABILITY SCREENING

- INTRODUCTION 10-2
- SILICON BIPOLAR TRANSISTORS 10-3
- GALLIUM ARSENIDE FETs 10-4
- MODAMP SILICON MMICs 10-5

QUALITY ASSURANCE, WARRANTY and ORDERING INFORMATION 11-2**AVANTEK SALES OFFICES, WORLDWIDE DISTRIBUTORS AND SALES REPRESENTATIVES**..... 11-7

PART NUMBER	PREVIOUS DESIGNATION	DESCRIPTION	PAGE NUMBER
AT-00500		General Purpose Silicon Bipolar Transistor	2-4
AT-00510		General Purpose Silicon Bipolar Transistor	2-7
AT-00535		General Purpose Silicon Bipolar Transistor	2-9
AT-00570		General Purpose Silicon Bipolar Transistor	2-11
AT-00572		General Purpose Silicon Bipolar Transistor	2-13
AT-01600		General Purpose Silicon Bipolar Transistor	2-15
AT-01610		General Purpose Silicon Bipolar Transistor	2-18
AT-01635		General Purpose Silicon Bipolar Transistor	2-20
AT-01670		General Purpose Silicon Bipolar Transistor	2-22
AT-01672		General Purpose Silicon Bipolar Transistor	2-24
AT-21400		Silicon Bipolar Oscillator Transistor	2-26
AT-41400		Low Noise Silicon Bipolar Transistor	2-28
AT-41410		Low Noise Silicon Bipolar Transistor	2-31
AT-41411		Low Noise Silicon Bipolar Transistor	2-34
AT-41435		Low Noise Silicon Bipolar Transistor	2-37
AT-41470		Low Noise Silicon Bipolar Transistor	2-40
AT-41472		Low Noise Silicon Bipolar Transistor	2-43
AT-41485		Low Noise Silicon Bipolar Transistor	2-45
AT-41486		Low Noise Silicon Bipolar Transistor	2-48
AT-42000		Medium Power Silicon Bipolar Transistor	2-51
AT-42010		Medium Power Silicon Bipolar Transistor	2-54
AT-42035		Medium Power Silicon Bipolar Transistor	2-57
AT-42070		Medium Power Silicon Bipolar Transistor	2-60
AT-42085		Medium Power Silicon Bipolar Transistor	2-63
AT-42086		Medium Power Silicon Bipolar Transistor	2-66
AT-60100		Low Noise Silicon Bipolar Transistor	2-69
AT-60200		Low Noise Silicon Bipolar Transistor	2-72
AT-60500		Low Noise Silicon Bipolar Transistor	2-75
AT-60510		Low Noise Silicon Bipolar Transistor	2-78
AT-60535		Low Noise Silicon Bipolar Transistor	2-81
AT-60570		Low Noise Silicon Bipolar Transistor	2-84
AT-60585		Low Noise Silicon Bipolar Transistor	2-87
AT-60586		Low Noise Silicon Bipolar Transistor	2-90
AT-64020		Linear Power Silicon Bipolar Transistor	2-94
AT-64023		Linear Power Silicon Bipolar Transistor	2-96
ATF-10136	ATF-10135	Low Noise Gallium Arsenide FET	3-6
ATF-10236	ATF-10235	Low Noise Gallium Arsenide FET	3-8
ATF-10736	ATF-20135	General Purpose Gallium Arsenide FET	3-10
ATF-13036		Low Noise Gallium Arsenide FET	3-13
ATF-13100		Low Noise Gallium Arsenide FET	3-15
ATF-13136	ATF-13135	Low Noise Gallium Arsenide FET	3-17
ATF-13170		Low Noise Gallium Arsenide FET	3-19
ATF-13284		Low Noise Gallium Arsenide FET	3-21
ATF-13336	ATF-13335	Low Noise Gallium Arsenide FET	3-23
ATF-13484		Low Noise Gallium Arsenide FET	3-25
ATF-13736	ATF-13735	General Purpose Gallium Arsenide FET	3-28

Alphanumeric Index

PART NUMBER	PREVIOUS DESIGNATION	DESCRIPTION	PAGE NUMBER
ATF-21100	AT-8111	Low Noise Gallium Arsenide FET	3-31
ATF-21170	AT-8110	Low Noise Gallium Arsenide FET	3-34
ATF-25100	AT-8251	Low Noise Gallium Arsenide FET	3-36
ATF-25170	AT-8250	Low Noise Gallium Arsenide FET	3-39
ATF-25570	AT-12570-5	General Purpose Gallium Arsenide FET	3-41
ATF-25735	AT-12535	General Purpose Gallium Arsenide FET	3-43
ATF-26100	AT-10600	General Purpose Gallium Arsenide FET	3-45
ATF-26150	AT-10650-1	General Purpose Gallium Arsenide FET	3-48
ATF-26350	AT-10650-3	General Purpose Gallium Arsenide FET	3-50
ATF-26550	AT-10650-5	General Purpose Gallium Arsenide FET	3-52
ATF-26836	AT-10635	General Purpose Gallium Arsenide FET	3-54
ATF-26884		General Purpose Gallium Arsenide FET	3-56
ATF-44100	AT-8141	Medium Power Gallium Arsenide FET	3-58
ATF-44101	AT-8140	Medium Power Gallium Arsenide FET	3-60
ATF-45100	AT-8151	Medium Power Gallium Arsenide FET	3-62
ATF-45101	AT-8150	Medium Power Gallium Arsenide FET	3-64
ATF-45171	AT-11571	Medium Power Gallium Arsenide FET	3-66
ATF-46100	AT-8161	Medium Power Gallium Arsenide FET	3-68
ATF-46101	AT-8160	Medium Power Gallium Arsenide FET	3-70
ATF-46171	AT-11671	Medium Power Gallium Arsenide FET	3-72
IAM-81018		MagIC Silicon MMIC Active Double Balanced Mixer/IF Amplifier ...	4-6
IAM-82018		MagIC Silicon MMIC Active Double Balanced Mixer/IF Amplifier ...	4-8
IFD-50010		MagIC Silicon MMIC Divide-by-4 Static Prescaler	4-10
IFD-50210		MagIC Silicon MMIC Divide-by-4 Static Prescaler	4-12
INA-01170		MagIC Low Noise Silicon MMIC Amplifier	4-14
INA-02170		MagIC Low Noise Silicon MMIC Amplifier	4-16
INA-03170		MagIC Low Noise Silicon MMIC Amplifier	4-18
IVA-05118		MagIC Silicon MMIC Variable Gain Amplifier	4-20
MGA-61000		General Purpose GaAs MMIC Amplifier	5-3
MGA-61100		General Purpose GaAs MMIC Amplifier	5-6
MGA-62100		Low Noise GaAs MMIC Amplifier	5-9
MGA-63100		Medium Power GaAs FET Cascade	5-12
MGA-64135		General Purpose GaAs MMIC Amplifier	5-15
MGA-65100		Medium Power GaAs FET Cascade	5-17
MSA-0100		MODAMP General Purpose Silicon MMIC Amplifier	4-22
MSA-0104		MODAMP General Purpose Silicon MMIC Amplifier	4-24
MSA-0135		MODAMP General Purpose Silicon MMIC Amplifier	4-26
MSA-0170		MODAMP General Purpose Silicon MMIC Amplifier	4-28
MSA-0185		MODAMP General Purpose Silicon MMIC Amplifier	4-30
MSA-0186		MODAMP General Purpose Silicon MMIC Amplifier	4-32
MSA-0200		MODAMP General Purpose Silicon MMIC Amplifier	4-34
MSA-0204		MODAMP General Purpose Silicon MMIC Amplifier	4-36
MSA-0235		MODAMP General Purpose Silicon MMIC Amplifier	4-38
MSA-0270		MODAMP General Purpose Silicon MMIC Amplifier	4-40
MSA-0285		MODAMP General Purpose Silicon MMIC Amplifier	4-42

Alphanumeric Index

PART NUMBER	PREVIOUS DESIGNATION	DESCRIPTION	PAGE NUMBER
MSA-0286		MODAMP General Purpose Silicon MMIC Amplifier	4-44
MSA-0300		MODAMP General Purpose Silicon MMIC Amplifier	4-46
MSA-0304		MODAMP General Purpose Silicon MMIC Amplifier	4-48
MSA-0311		MODAMP General Purpose Silicon MMIC Amplifier	4-50
MSA-0335		MODAMP General Purpose Silicon MMIC Amplifier	4-52
MSA-0370		MODAMP General Purpose Silicon MMIC Amplifier	4-54
MSA-0385		MODAMP General Purpose Silicon MMIC Amplifier	4-56
MSA-0386		MODAMP General Purpose Silicon MMIC Amplifier	4-58
MSA-0400		MODAMP Medium Power Silicon MMIC Amplifier	4-60
MSA-0404		MODAMP Medium Power Silicon MMIC Amplifier	4-64
MSA-0420		MODAMP Medium Power Silicon MMIC Amplifier	4-66
MSA-0435		MODAMP Medium Power Silicon MMIC Amplifier	4-68
MSA-0470		MODAMP Medium Power Silicon MMIC Amplifier	4-70
MSA-0485		MODAMP Medium Power Silicon MMIC Amplifier	4-72
MSA-0486		MODAMP Medium Power Silicon MMIC Amplifier	4-74
MSA-0504		MODAMP Medium Power Silicon MMIC Amplifier	4-76
MSA-0505		MODAMP Medium Power Silicon MMIC Amplifier	4-78
MSA-0520		MODAMP Medium Power Silicon MMIC Amplifier	4-80
MSA-0600		MODAMP Low Noise Silicon MMIC Amplifier	4-82
MSA-0611		MODAMP Low Noise Silicon MMIC Amplifier	4-84
MSA-0635		MODAMP Low Noise Silicon MMIC Amplifier	4-86
MSA-0670		MODAMP Low Noise Silicon MMIC Amplifier	4-88
MSA-0685		MODAMP Low Noise Silicon MMIC Amplifier	4-90
MSA-0686		MODAMP Low Noise Silicon MMIC Amplifier	4-92
MSA-0700		MODAMP Low Noise Silicon MMIC Amplifier	4-94
MSA-0711		MODAMP Low Noise Silicon MMIC Amplifier	4-96
MSA-0735		MODAMP Low Noise Silicon MMIC Amplifier	4-98
MSA-0770		MODAMP Low Noise Silicon MMIC Amplifier	4-100
MSA-0785		MODAMP Low Noise Silicon MMIC Amplifier	4-102
MSA-0786		MODAMP Low Noise Silicon MMIC Amplifier	4-104
MSA-0800		MODAMP Low Noise Silicon MMIC Amplifier	4-106
MSA-0835		MODAMP Low Noise Silicon MMIC Amplifier	4-108
MSA-0870		MODAMP Low Noise Silicon MMIC Amplifier	4-110
MSA-0885		MODAMP Low Noise Silicon MMIC Amplifier	4-112
MSA-0886		MODAMP Low Noise Silicon MMIC Amplifier	4-114
MSA-0910		MODAMP High Frequency Silicon MMIC Amplifier	4-116
MSA-0986		MODAMP High Frequency Silicon MMIC Amplifier	4-118
MSA-1023		MODAMP Medium Power Silicon MMIC Amplifier	4-120
MSA-1104		MODAMP High Dynamic Range Silicon MMIC Amplifier	4-122
MSA-1105		MODAMP High Dynamic Range Silicon MMIC Amplifier	4-124
MSA-1110		MODAMP High Dynamic Range Silicon MMIC Amplifier	4-126
MSA-1120		MODAMP High Dynamic Range Silicon MMIC Amplifier	4-128
MSA-9970		MODAMP Open Loop Feedback Amplifier	4-130
MSF-86 Series		Silicon MMIC Frequency Converter	4-132
MSF-88 Series		Silicon MMIC Frequency Converter	4-136



This page is intentionally blank.

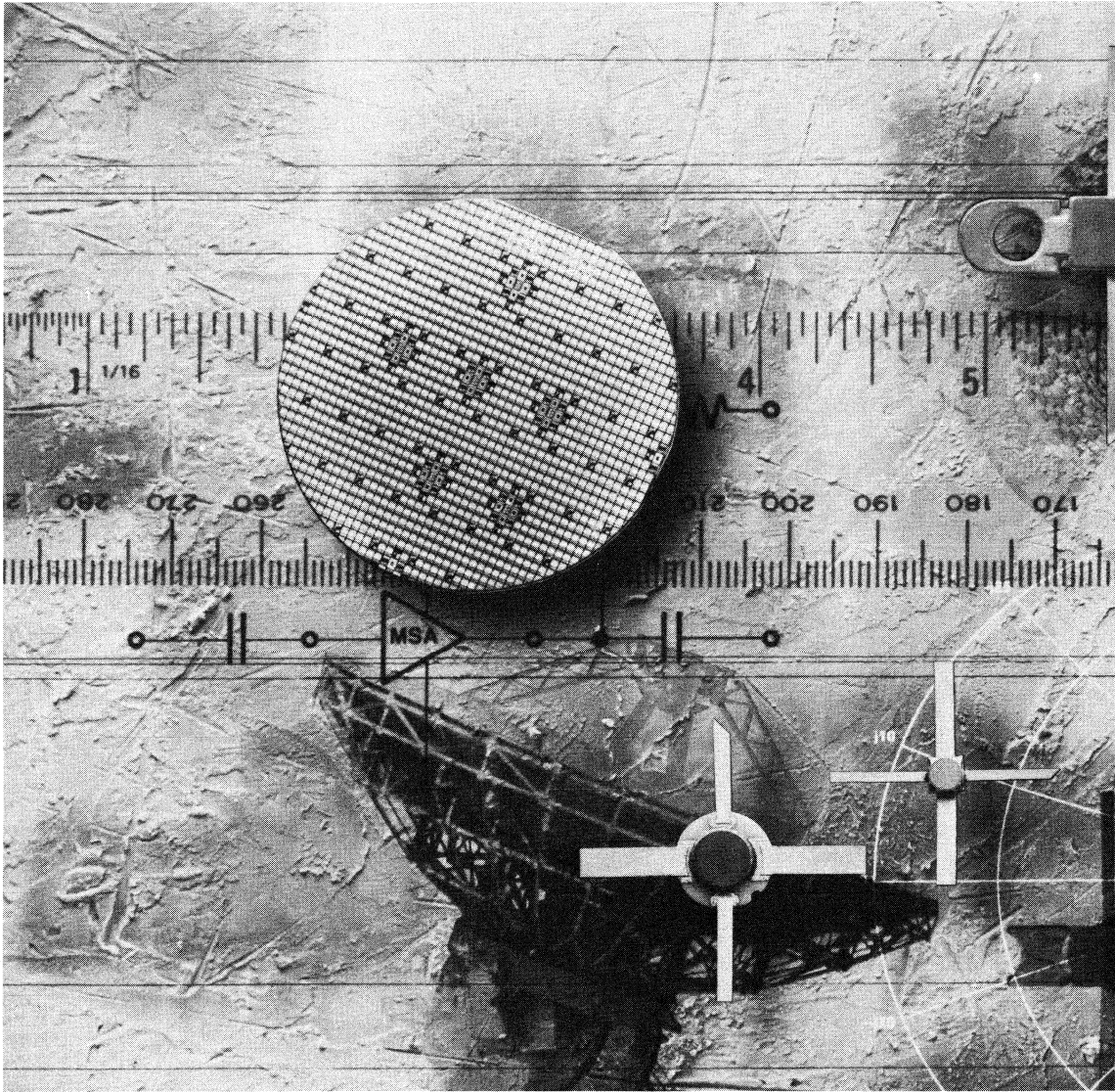

Introduction

**SOME INFORMATION
ABOUT THIS DATA BOOK 1-2**

**AVANTEK
VERTICAL INTEGRATION 1-3**

24 YEAR HISTORY 1-6

OTHER COMPANY PRODUCTS . . . 1-7

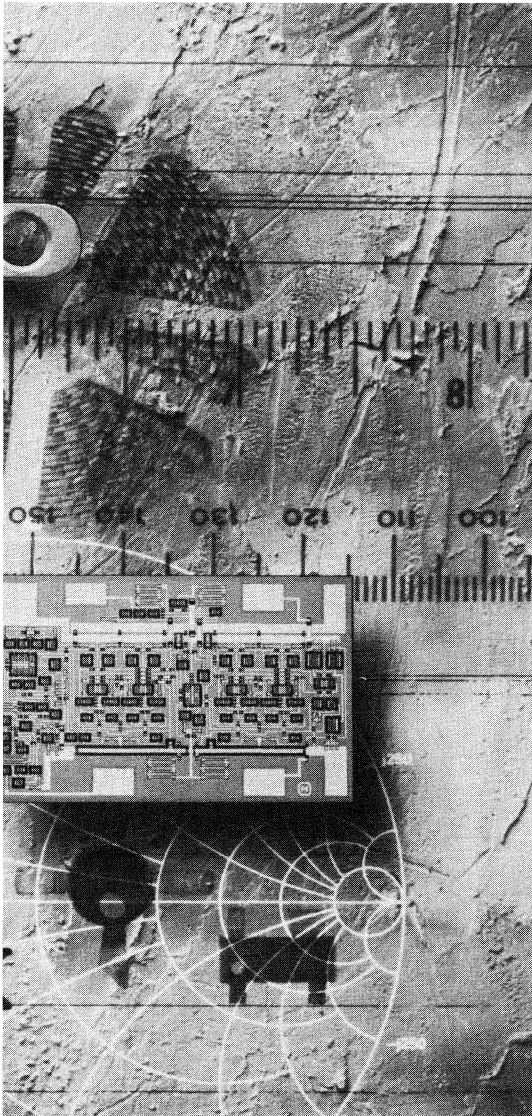

SOME INFORMATION ABOUT THIS DATA BOOK

Microwave Semiconductors

Avantek's Microwave Semiconductors Data Book contains detailed information on our full line of standard gallium arsenide and silicon semiconductors. The products are arranged into the following sections:

1. Microwave silicon bipolar transistors
2. Gallium arsenide field-effect transistors
3. Silicon monolithic microwave integrated circuits
4. Gallium arsenide microwave integrated circuits

Available Through Distribution

All microwave semiconductors listed in this book are available through Avantek's network of authorized distributors. For pricing information or to place an order, please contact any Avantek field sales office, sales representative or distributor listed at the back of this book.

AVANTEK VERTICAL INTEGRATION

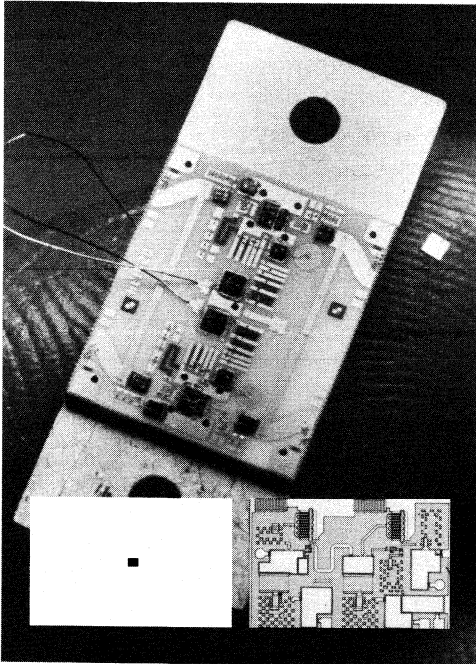

The tiny GaAs monolithic microwave integrated circuit performs the same basic function as the similar hybrid circuit in 1/25th the area and eliminates most circuit adjustments. Insets: The same MMIC shown actual size and enlarged 35 times.

From Transistors and MMICs to Advanced Integrated Subassemblies

1. Space-Age Technology:

- Silicon and GaAs transistors
- Silicon and GaAs Monolithic Microwave Integrated Circuits (MMICs)
- Thin-film hybrid Microwave Integrated Circuits (MICs)
- Mixers and RF switches
- Advanced fabrication technology
- Proprietary packaging

2. Premium Product Performance:

- GaAs FETs operating beyond 60 GHz
- GaAs MMICs through 20 GHz
- Widest oscillator and amplifier bandwidths
 - Only available 2-18, 18-40 GHz transistor amplifiers
 - Only available 18-26, 26-40 and 33-50 GHz transistor YTOs
- Lowest amplifier noise figures

Frequency Spectrum Chart

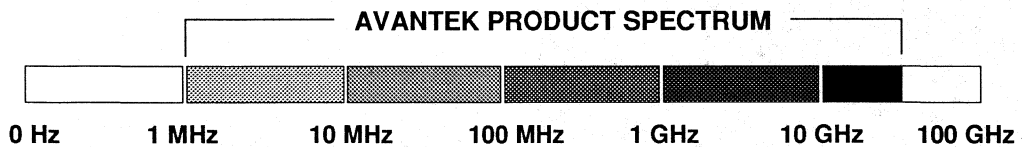

RADIO COMMUNICATIONS



SATELLITE COMMUNICATIONS



MICROWAVE RELAY



ELECTRONIC DEFENSE

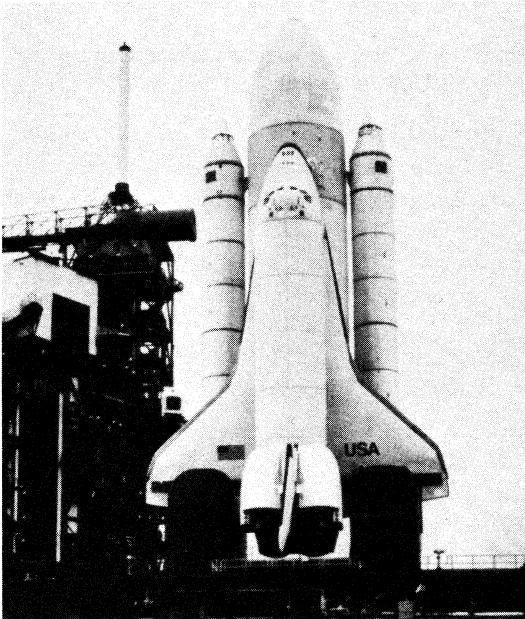

3. High Quality/Reliability

- Supplier to virtually all airborne electronic warfare systems
- Space-qualified products
- Integrated QA/QC system
- High-reliability screening



4. Vertical Integration

- Microwave transistors
- Silicon and GaAs MMICs
- Modular amplifiers and signal-processing components
- Modular signal control components
- Wideband and communications/radar-band amplifiers
- Variable- and fixed-frequency oscillators
- Digitally- and voltage-tuned oscillator and filter assemblies
- Downconverters, amplifier-downconverters and mixer-preamps
- Multifunction subassemblies
- Over 700 standard products

5. Volume Manufacturing Capability

- Four U.S. manufacturing facilities
- 600,000 sq. ft.
- Over 2600 employees
- Industry's most advanced microwave semiconductor facility
- Three million product units shipped in five years (excluding semiconductors)

6. Over 20 Years of Experience

- Manufacturing solid-state microwave components since 1965
- Semiconductors and thin-film hybrids since 1968
- Tunable microwave oscillators since 1969
- Microwave mixers since 1980
- Monolithic Microwave ICs since 1982
- Thin-film mixers since 1986
- HEMTs and MSI MMICs since 1987
- 60 GHz amplifiers since 1988

NEWARK



FOLSOM



MILPITAS

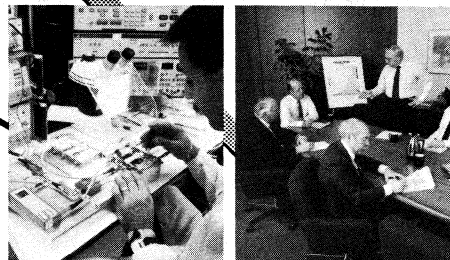

SANTA CLARA

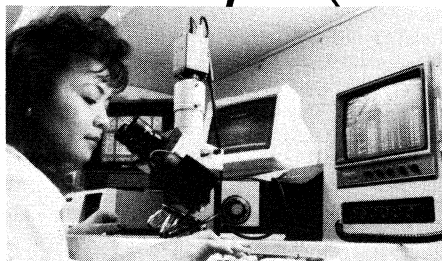

Avantek, Inc. was founded in late 1965 to meet the electronic industry's need for high performance solid state VHF, UHF and microwave transistor amplifiers.

By December, 1965, the company had developed and introduced a family of low-noise solid state preamplifiers covering the 30 to 1000 MHz frequency range. Less than six months later, Avantek added solid state microwave amplifiers with octave band coverage through 2300 MHz as well as narrow-band amplifiers for specific communications bands in that frequency range. This early family of highly reliable

Avantek transistor amplifiers played a significant part in the microwave industry's decision to replace tube-type amplifiers with solid state.

Advances in solid state amplifier technology were hampered in these early years by the limited and sporadic availability of microwave transistors. Device suppliers simply were not able to keep pace with the progress made by Avantek circuit designers.

Consequently, in the spring of 1968, Avantek added the staff and facilities to design, develop and manufacture its own gold-metalized planar epitaxial microwave transistors. The capability to design and produce high performance microwave transistors in-house is one of the important factors leading to Avantek's present success. Today, virtually every microwave transistor used in an Avantek product is an Avantek transistor. In 1968, Avantek also established a facility for the production of hybrid thin-film microwave integrated circuits (MICs).

In February, 1970, Avantek was granted a patent on the techniques of producing unconditionally-stable, cascadable wideband amplifier modules. This concept resulted in a wide variety of modular "gain blocks" in packages ranging from conventional cases with connectors to tiny thin-film modules in TO-8 and TO-12 transistor packages. To meet the needs of both the commercial and military user.

Avantek introduced thin-film fundamental YIG-tuned transistor oscillators in 1969. In 1973, varactor-tuned transistor oscillators were added to the growing component line. Some more-recent Avantek developments include:

1981

- 5-watt communications/radar-band GaAs FET amplifiers.
- Dielectrically-stabilized microwave oscillators.
- Avapack flatpack amplifiers through 18 GHz.
- YIG filters.
- 1 Watt, 4-8 GHz GaAs FET amplifier.

1982

- Industry's first 40+ GHz GaAs FET.

1983

- Silicon monolithic microwave ICs into production
- Industry's first 26.5-40 GHz GaAs FET amplifier
- 10 watt 6 GHz amplifiers.
- 45 watt, 900 MHz amplifiers.
- Industry's first 26.5-40 GHz GaAs FET YIG-tuned oscillator.

1984

- GaAs monolithic amplifiers introduced
- Industry's first 18-40 GHz GaAs FET amplifiers
- PlanarPak package

1985

- Industry's first 2 watt, 20 GHz GaAs FET.
- Industry's first 55 watt bipolar transistor @ 900 MHz

1986

- Tunable dielectric-resonator oscillators
- Low-cost, plastic-packaged MMIC amplifiers
- Industry's first 33-50 GHz YIG-tuned GaAs FET oscillator
- Industry's first 45 GHz GaAs FET amplifier

1987

- Patented fast-switching multi-resonator DRO design
- 6-18 GHz, 1-watt power amplifier.
- 2-20 GHz, quarter-watt MMIC.

1988

- HEMT device with 0.5 dB noise figure at 12 GHz
- 35 GHz HEMT with 12 dB gain.
- Industry's first medium-scale integration (MSI) silicon MMICs.
- 60 GHz integrated amplifier/downconverter

Today, Avantek is the world's leading manufacturer of microwave products. During the past two decades Avantek has produced more Monolithic Microwave Integrated Circuits (MMICs), wideband solid state microwave and millimeter-wave amplifiers, YIG-tuned oscillators and low-noise communications/radar amplifiers than all other U.S. manufacturers combined. Over the past five years Avantek has shipped nearly three million product units (excluding all semiconductor devices) to over 3000 customers.

Today the Avantek microwave product line includes:

- Microwave Semiconductors
 - Silicon Bipolar Transistors
 - Gallium Arsenide Field Effect Transistors
 - GaAs and Silicon Monolithic Microwave Integrated Circuits
- Avapack Miniature Flatpack Products
- PlanarPak Surface-Mount Products
- Control Components:
 - Mixers
 - Switches
 - Limiters
 - Attenuators
- YIG-tuned Oscillators and Filters
- Varactor-Tuned Oscillators
- Dielectric Resonator Oscillators
- Wideband Microwave Amplifiers
- Low-Noise Communications Amplifiers
- Power Amplifiers
- Modular Amplifiers
- Special-Purpose Amplifiers
- Multifunction Integrated Assemblies

Avantek products cover frequencies from DC to 60 GHz for use in electronic defense and radar; missiles and satellites; test equipment and instrumentation; and communications equipment for the military, commercial, industrial and consumer markets, both domestic and international.

Avantek Employees and Facilities: Today there are over 2600 employees in the Avantek family supported by some of the industry's most modern equipment and facilities. Manufacturing, engineering and administrative facilities, all located in

California, include 255,000 sq. ft. in Santa Clara, 180,000 sq. ft. in Milpitas, 88,000 sq. ft. in Folsom and 90,000 sq. ft. in Newark. AvanteK also has a facility in Farnborough, UK to support European requirements. This staff and floorspace supports AvanteK's fundamental vertical integration strategy:

to manufacture high-performance microwave semiconductors, to build these into amplifiers and other functional "building blocks," to integrate these functions into multifunction assemblies—and to support all products with research, engineering, quality control and customer support..

OTHER COMPANY PRODUCTS

MICROWAVE AND MILLIMETER WAVE AMPLIFIERS

AvanteK produces microwave/millimeter-wave amplifiers operating at frequencies through 60 GHz. Its products include low-noise, wideband amplifiers; GaAs FET thin-film limiting amplifiers, temperature-compensated GaAs FET amplifiers; wideband, medium-power amplifiers; solid-state TWT replacement amplifiers and communications- and radar-band amplifiers for low-noise preamplification, medium-power driver and high-power output applications. Standard amplifier products are listed in the *AvanteK Microwave and Millimeter Wave Amplifiers Data Book*.

MODULAR AND OSCILLATOR COMPONENTS

AvanteK modular products are essentially miniature functional blocks designed to operate in standard 50-ohm environments, for incorporation in microwave systems. These products are packaged in TO-8, TO-39 and TO-12 hermetic metal cans, the unique PlanarPak surface-mount package, the AvanteK miniature flatpack and dual-inline packages. These, along with AvanteK's extensive range of compact fixed and variable-frequency signal sources are listed in the AvanteK Modular and Oscillator Components Data Book. Coverage of that publication includes:

- IF/RF amplifiers, TO-8 and PlanarPak packages: 10 MHz to 2 GHz
- Surface-mount amplifiers, *PlanarPak* package: 1 to 18 GHz
- AGC amplifiers, TO-3 and TO-8 packages: 5 to 1000 MHz
- Limiters, TO-8, DIP and *PlanarPak* packages: 5 to 1000 MHz
- Amplifiers, *AvanteK* miniature flatpack: 10 MHz to 4 GHz
- Low-cost TO-12 to TO-39 amplifiers: 0.1 MHz to 1500 MHz
- Voltage-controlled attenuators, TO-8 and *PlanarPak* packages: 5 MHz to 2 GHz
- Level and threshold detectors, TO-8 and *PlanarPak* packages: 10 MHz to 2 GHz
- Power splitters, *AvanteK* package: 2 to 18 GHz
- Mixers, *AvanteK*, *PlanarPak* and TO-8 package: 0.75 to 18 GHz
- Mixer-preamplifiers, *AvanteK* package: 0.5 to 18 GHz input
- PIN-diode switches, *AvanteK* package: SPST through SP5T, reflective and non-reflective: 2 to 18 GHz
- Limiters, *AvanteK*, TO-8, TO-12 packages: 2 to 18 GHz

SIGNAL SOURCES

- Varactor-tuned oscillators (VCOs): 300 MHz to 18 GHz
- Dielectric Resonator oscillators: fixed; mechanically—and electrically-tunable: 3 to 18 GHz
- YIG-tuned oscillators: 1 to 50 GHz
- YIG Filters: 0.5 to 26.5 GHz

HOW TO USE THE DATABOOK SERIES

The AvanteK Databook set consists of the following items:

1. Product Guide
2. Microwave Semiconductor Data Book
3. Modular and Oscillator Components Data Book
4. Microwave and Millimeter Wave Amplifier Data Book

Item 1, the Product Guide, provides summary specifications for all of AvanteK's standard products at time of publication. Custom and special products are described. It is suggested that this Product Guide be used as the first reference to locate appropriate AvanteK products. When potentially useful products have been identified, the user should refer to items 2 through 4, the data books, which provide complete, detailed data on all standard AvanteK products in that category plus applications notes and other related information. Some products, such as modular amplifiers, may appear in more than one databook for user convenience.

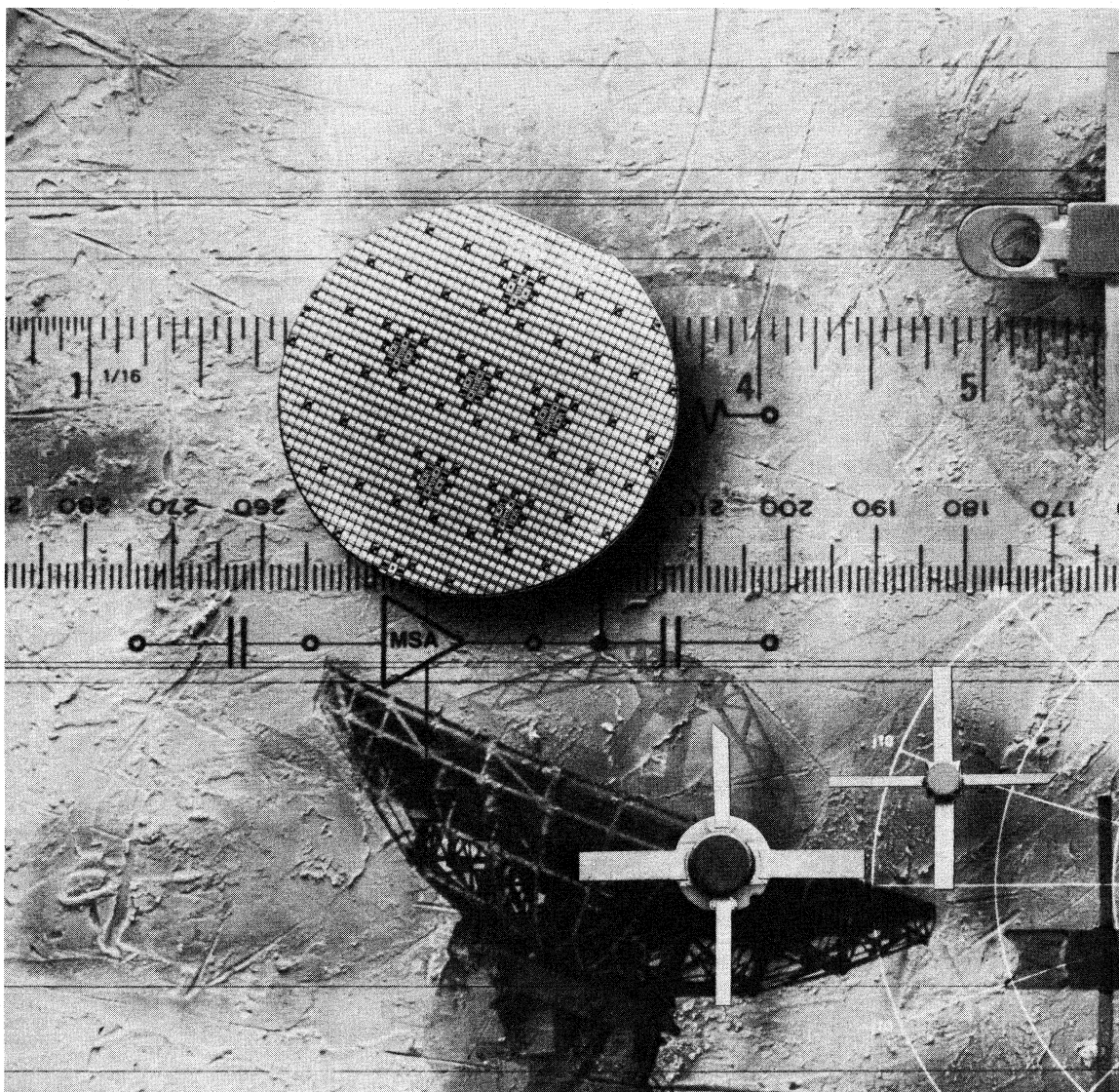

Microwave Silicon Bipolar Transistors

SELECTION GUIDE 2-2

AT-SERIES 2-4

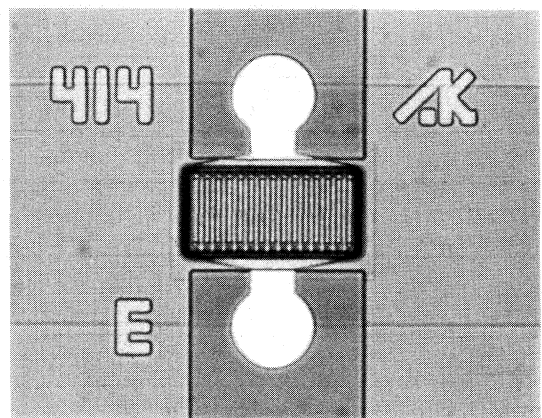
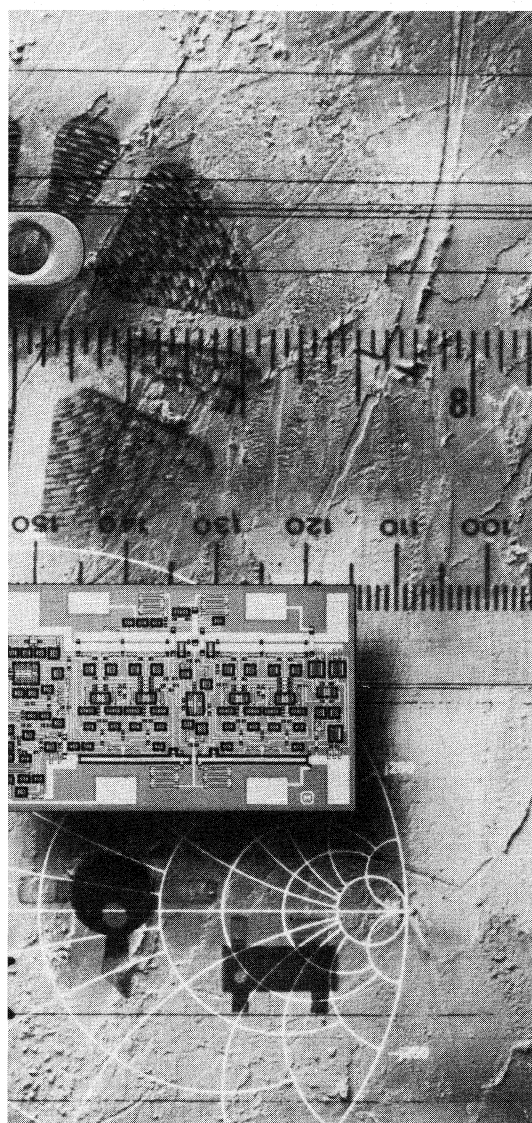

SILICON BIPOLAR TRANSISTORS
LOW NOISE TRANSISTORS

(Typical Specifications @ 25°C Case Temperature)

Part Number	Maximum Useable Frequency ¹ (GHz)	Test Frequency (GHz)	NF ₀ (dB)	P _{1 dB} (dBm)	S ₂₁ ² @ 1 GHz (dB)	f _{max} ² (GHz)	Case Type	Page Number
AT-41400	4.5	2.0	1.6	19.0	18.0	16.0	chip	2-28
AT-60100	3.0	2.0	1.9	4.0	12.5	15.0	chip	2-69
AT-60200	3.5	2.0	1.9	6.5	15.5	15.0	chip	2-72
AT-60500	4.0	2.0	1.8	16.0	17.5	15.0	chip	2-75
AT-41410	4.5	2.0	1.6	19.0	18.0	15.0	100 mil stripline	2-31
AT-60510	4.0	2.0	1.8	16.0	17.5	14.0	100 mil stripline	2-78
AT-41435	4.2	2.0	1.7	19.0	17.5	14.0	micro-X	2-37
AT-60535	4.0	2.0	1.8	16.0	17.0	13.0	micro-X	2-81
AT-41470	4.5	2.0	1.6	19.0	18.0	16.0	70 mil stripline	2-40
AT-60570	4.0	2.0	1.8	16.0	17.5	15.0	70 mil stripline	2-84
AT-41472	1.0	0.5	1.3	20.5	11.5	8.0	TO-72	2-43
AT-41411	3.5	1.0	1.4	17.5	16.5	11.0	SOT-143 plastic	2-34
AT-41485	4.0	1.0	1.4	18.5	17.5	13.0	85 mil plastic	2-45
AT-41486	4.0	1.0	1.4	18.5	17.5	12.0	surface mount plastic	2-48
AT-60585	4.0	1.0	1.4	15.0	17.0	12.0	85 mil plastic	2-87
AT-60586	4.0	1.0	1.4	15.0	17.0	12.0	surface mount plastic	2-90

GENERAL PURPOSE AND MEDIUM POWER TRANSISTORS

(Typical Specifications @ 25°C Case Temperature)

Part Number	Maximum Useable Frequency ¹ (GHz)	Test Frequency (GHz)	NF ₀ (dB) Typ.	P _{1 dB} (dBm)	S ₂₁ ² @ 1 GHz (dB)	f _{max} ² (GHz)	Case Type	Page Number
AT-00500	3.0	2.0	2.5	16.0	15.5	9.0	chip	2-4
AT-01600	2.3	2.0	3.0	22.0	13.0	9.0	chip	2-15
AT-42000	3.8	2.0	1.9	21.0	17.0	15.0	chip	2-51
AT-00510	3.0	2.0	2.5	16.0	15.0	8.0	100 mil stripline	2-7
AT-01610	2.3	2.0	3.0	22.0	12.5	8.0	100 mil stripline	2-18
AT-42010	3.8	2.0	1.9	21.0	17.0	14.0	100 mil stripline	2-54
AT-00535	3.0	2.0	2.5	16.0	15.0	8.0	micro-X	2-9
AT-01635	2.2	2.0	3.0	22.0	12.0	8.0	micro-X	2-20
AT-42035	3.8	2.0	1.9	21.0	17.0	14.0	micro-X	2-57
AT-00570	3.0	2.0	2.5	16.0	15.5	9.0	70 mil stripline	2-11
AT-01670	2.3	2.0	3.0	22.0	13.0	9.0	70 mil stripline	2-22
AT-42070	3.8	2.0	1.9	21.0	17.5	15.0	70 mil stripline	2-60
AT-00572	1.0	0.5	1.9	19.0	10.0	4.0	TO-72	2-13
AT-01672	1.0	0.5	2.0	24.0	9.0	3.0	TO-72	2-24
AT-42085	3.5	1.0	1.4	20.5	17.0	12.0	85 mil plastic	2-63
AT-42086	3.5	1.0	1.4	20.5	17.0	11.0	surface mount plastic	2-66

LINEAR POWER TRANSISTORS

(Typical Specifications @ 25°C Case Temperature)

Part Number	Maximum Useable Frequency ¹ (GHz)	Test Frequency (GHz)	P _{1 dB} (dBm)	G _{1 dB} (dBm)	S ₂₁ ² @ 1 GHz (dB)	f _{max} ² (GHz)	Case Type	Page Number
AT-64020	2.0	2.0	28.0	10.0	12.5	8.0	200 mil BeO disk	2-94
AT-64023	2.2	4.0	27.0	9.5	12.0	8.0	230 mil Flange BeO	2-96

- Notes: 1. Frequency at which |S₂₁|² gain equals 6 dB.
2. Frequency at which unilateral gain equals unity or 0 dB.

SILICON BIPOLAR TRANSISTORS

OSCILLATOR TRANSISTORS

(Typical Specifications @ 25°C)

Part Number	Recommended Operating Frequency Range ¹ (GHz)	f_{max}^2 (GHz)	Output Power @ 4.0 GHz (dBm)	MAG @ 4.0 GHz (dB)	$ S_{21E} ^2$ @ 4.0 GHz (dB)	Case Type	Page Number
AT-21400	up to >20	40	13	16.5	9.5	chip	2-26
AT-41400	up to >10	25	19	11.0	6.5	chip	2-28
AT-42000	up to >10	25	21	11.0	5.5	chip	2-51
AT-60500	up to >8	18	15	11.0	6.5	chip	2-75

- Notes: 1. For fundamental oscillation.
2. Frequency at which unilateral gain equals unity or 0 dB.

TYPICAL PERFORMANCE: SILICON BIPOLAR TRANSISTORS @ $T_A = 25^\circ\text{C}$

OPTIMUM NOISE FIGURE
vs. FREQUENCY

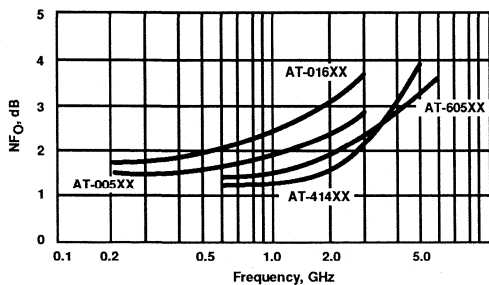

INSERTION POWER GAIN
vs. COLLECTOR CURRENT
f = 2.0 GHz

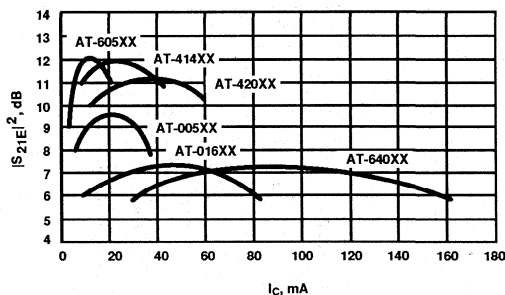

Features

- 16.0 dBm typical $P_{1\text{ dB}}$ at 2.0 GHz
- 11.5 dB typical $G_{1\text{ dB}}$ at 2.0 GHz
- 2.5 dB typical NF_0 at 2.0 GHz
- High Gain-Bandwidth Product: 9.0 GHz typical f_T

Description

Avantek's AT-00500 is a high performance NPN silicon bipolar transistor chip designed for use in wide band amplifier and oscillator applications operating over VHF, UHF and microwave frequencies.

The die are nitride-passivated for surface protection. Excellent device uniformity, performance and reliability are produced by the use of ion-implantation, self-alignment techniques, and gold metallization in the fabrication of these devices.

The recommended assembly procedure is gold-eutectic die attach at 400°C and either wedge or ball bonding using 0.7 mil gold wire. See also "Chip Use" in the APPLICATIONS section.

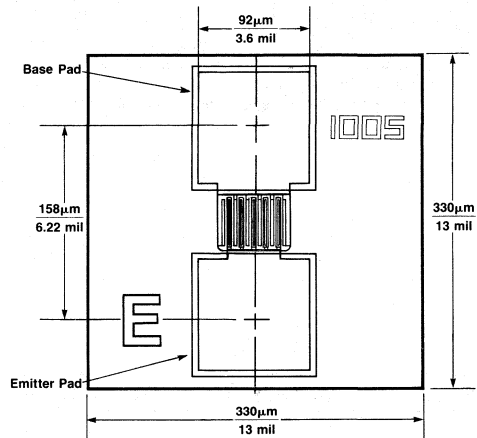
Avantek Chip Outline

INSERTION POWER GAIN, MAXIMUM AVAILABLE
 GAIN AND MAXIMUM STABLE GAIN
 vs. FREQUENCY
 $V_{CE} = 8\text{ V}, I_C = 20\text{ mA}$

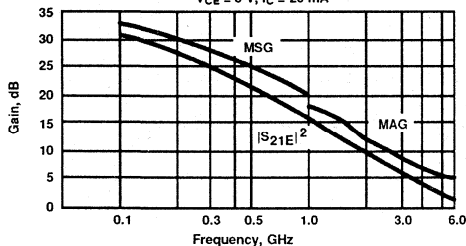
Electrical Specifications, $T_A = 25^\circ\text{C}$

Symbol	Parameters and Test Conditions ¹	Units	Min.	Typ.	Max.
$ S_{21E} ^2$	Insertion Power Gain: $V_{CE} = 8\text{ V}, I_C = 20\text{ mA}$ $f = 1.0\text{ GHz}$ $f = 2.0\text{ GHz}$	dB		15.5 9.5	
$P_{1\text{ dB}}$	Power Output @ 1 dB Gain Compression: $V_{CE} = 8\text{ V}, I_C = 20\text{ mA}$ $f = 2.0\text{ GHz}$	dB		16.0	
$G_{1\text{ dB}}$	1 dB Compressed Gain: $V_{CE} = 8\text{ V}, I_C = 20\text{ mA}$ $f = 2.0\text{ GHz}$	dB		11.5	
NFO	Optimum Noise Figure: $V_{CE} = 8\text{ V}, I_C = 5\text{ mA}$ $f = 2.0\text{ GHz}$	dB		2.5	
GA	Gain @ NFO: $V_{CE} = 8\text{ V}, I_C = 5\text{ mA}$ $f = 2.0\text{ GHz}$	dB		10.5	
f_T	Gain Bandwidth Product: $V_{CE} = 8\text{ V}, I_C = 20\text{ mA}$	GHz		9.0	
h_{FE}	Forward Current Transfer Ratio: $V_{CE} = 8\text{ V}, I_C = 20\text{ mA}$		30	150	300
I_{CBO}	Collector Cutoff Current: $V_{CB} = 8\text{ V}$	μA			0.2
I_{EBO}	Emitter Cutoff Current: $V_{EB} = 1\text{ V}$	μA			1.0
CCB	Collector Base Capacitance ² : $V_{CB} = 8\text{ V}, f = 1\text{ MHz}$	pF		0.45	

Notes: 1. RF performance is determined by packaging and testing 10 devices per wafer.
 2. For this test, the emitter is grounded.

Absolute Maximum Ratings

Parameter	Symbol	Absolute Maximum ¹
Emitter-Base Voltage	VEBO	1.5 V
Collector-Base Voltage	VCBO	20 V
Collector-Emitter Voltage	VCEO	12 V
Collector Current	IC	50 mA
Power Dissipation ^{2,3}	PT	500 mW
Junction Temperature	Tj	200°C
Storage Temperature	TSTG	-65°C to 200°C

Thermal Resistance^{2,4}: $\theta_{JC} = 75^\circ\text{C/W}$

Notes:

1. Operation of this device above any one of these parameters may cause permanent damage.
2. TCASE = 25°C.
3. Derate at 13.3 mW/°C for TC > 163°C.
4. The small spot size of this technique results in a higher, though more accurate determination of θ_{JC} than do alternate methods. See MEASUREMENTS section "Thermal Resistance" for more information.

Part Number Ordering Information

Part Number	Devices Per Tray
AT-00500-GP2	10
AT-00500-GP4	100
AT-00500-GP6	up to 300

Typical Performance, TA = 25°C

(unless otherwise noted)

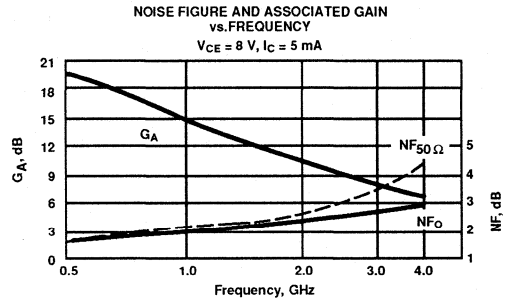
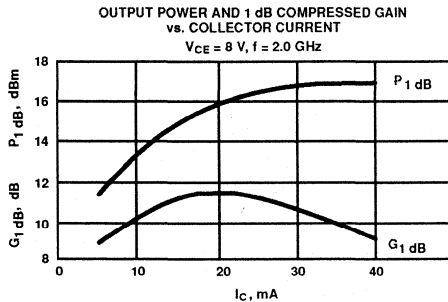
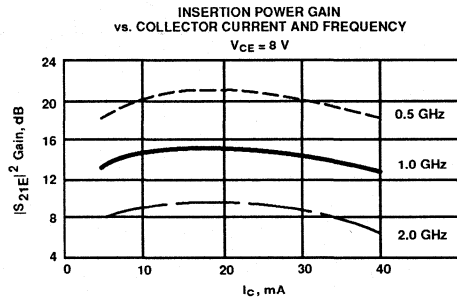
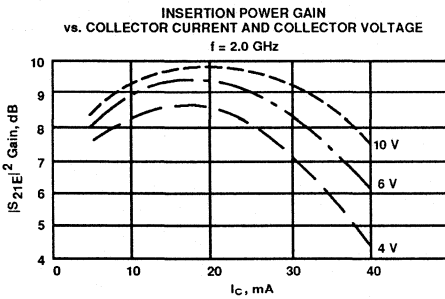

AT-00500

General Purpose Silicon Bipolar Transistor

Typical Scattering Parameters: Common Emitter, $Z_0 = 50 \Omega$

$T_A = 25^\circ\text{C}$, $V_{CE} = 8 \text{ V}$, $I_C = 5 \text{ mA}$

Freq. GHz	S ₁₁		S ₂₁			S ₁₂			S ₂₂	
	Mag	Ang	dB	Mag	Ang	dB	Mag	Ang	Mag	Ang
0.1	.87	-29	23.2	14.43	161	-32.4	.024	76	.96	-14
0.5	.66	-103	18.2	8.17	116	-23.2	.069	45	.61	-42
1.0	.57	-142	13.6	4.78	94	-21.4	.085	40	.44	-47
1.5	.54	-162	10.2	3.24	81	-20.4	.096	44	.39	-50
2.0	.54	-176	8.0	2.51	72	-19.4	.107	49	.38	-53
2.5	.54	178	6.1	2.02	64	-18.6	.118	52	.38	-55
3.0	.56	171	4.8	1.73	55	-17.5	.134	53	.39	-59
3.5	.56	163	3.6	1.52	51	-16.5	.149	58	.40	-63
4.0	.58	158	2.5	1.33	44	-15.9	.160	59	.43	-66
4.5	.59	153	1.6	1.20	39	-15.1	.176	60	.46	-71
5.0	.59	149	0.6	1.07	33	-14.2	.194	61	.48	-76
5.5	.60	144	-0.1	0.99	29	-13.8	.204	62	.50	-83
6.0	.62	141	-1.1	0.88	23	-13.4	.215	63	.54	-88

$T_A = 25^\circ\text{C}$, $V_{CE} = 8 \text{ V}$, $I_C = 20 \text{ mA}$

0.1	.64	-66	30.4	33.05	145	-35.4	.017	65	.82	-29
0.5	.56	-149	21.1	11.31	99	-28.4	.038	52	.34	-53
1.0	.55	-172	15.5	5.96	86	-24.9	.057	61	.25	-52
1.5	.55	178	11.9	3.95	77	-22.3	.077	66	.24	-54
2.0	.56	169	9.6	3.03	70	-20.3	.097	68	.25	-56
2.5	.55	165	7.6	2.41	64	-18.8	.115	69	.26	-59
3.0	.57	160	6.3	2.06	57	-17.3	.136	69	.27	-63
3.5	.57	155	5.1	1.81	53	-16.2	.155	70	.28	-67
4.0	.59	150	3.9	1.57	47	-15.4	.170	69	.32	-70
4.5	.60	146	3.1	1.42	43	-14.3	.192	69	.35	-75
5.0	.60	144	2.1	1.27	38	-13.7	.207	62	.37	-79
5.5	.62	139	1.4	1.18	33	-13.1	.221	68	.39	-85
6.0	.62	136	0.4	1.05	29	-12.5	.237	68	.43	-90

A model for this device is available in the DEVICE MODELS section.

Features

- 16.0 dBm typical $P_{1\text{ dB}}$ at 2.0 GHz
- 10.5 dB typical $G_{1\text{ dB}}$ at 2.0 GHz
- 2.5 dB typical N_{F0} at 2.0 GHz
- High Gain-Bandwidth Product: 8.0 GHz typical f_T
- Hermetic Gold-ceramic Microstrip Package

Description

Avantek's AT-00510 is a high performance NPN silicon bipolar transistor housed in a hermetic, high reliability package. This device is designed for use in wide band amplifier and oscillator applications operating over VHF, UHF and microwave frequencies.

Excellent device uniformity, performance and reliability are produced by the use of ion-implantation, self-alignment techniques, and gold metallization in the fabrication of these devices.

Avantek 100 mil Package

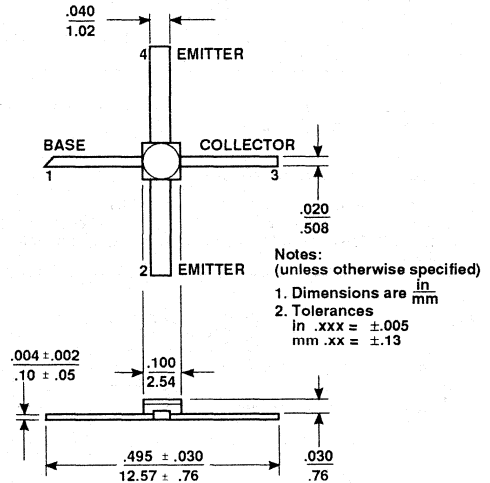

INSERTION POWER GAIN, MAXIMUM AVAILABLE GAIN AND MAXIMUM STABLE GAIN vs. FREQUENCY
 $V_{CE} = 8\text{ V}, I_C = 20\text{ mA}$

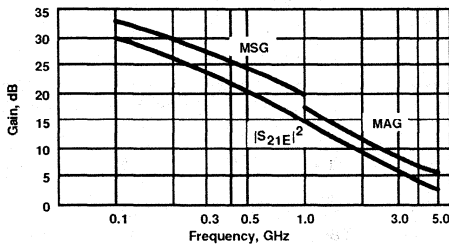

Electrical Specifications, $T_A = 25^\circ\text{C}$

Symbol	Parameters and Test Conditions	Units	Min.	Typ.	Max.
$ S_{21E} ^2$	Insertion Power Gain: $V_{CE} = 8\text{ V}, I_C = 20\text{ mA}$ $f = 1.0\text{ GHz}$ $f = 2.0\text{ GHz}$	dB	13.0	15.0 9.0	
$P_{1\text{ dB}}$	Power Output @ 1 dB Gain Compression: $V_{CE} = 8\text{ V}, I_C = 20\text{ mA}$ $f = 2.0\text{ GHz}$	dBm		16.0	
$G_{1\text{ dB}}$	1 dB Compressed Gain: $V_{CE} = 8\text{ V}, I_C = 20\text{ mA}$ $f = 2.0\text{ GHz}$	dB		10.5	
N_{F0}	Optimum Noise Figure: $V_{CE} = 8\text{ V}, I_C = 5\text{ mA}$ $f = 2.0\text{ GHz}$	dB		2.5	
G_A	Gain @ N_{F0} : $V_{CE} = 8\text{ V}, I_C = 5\text{ mA}$ $f = 2.0\text{ GHz}$	dB		10.5	
f_T	Gain Bandwidth Product: $V_{CE} = 8\text{ V}, I_C = 20\text{ mA}$	GHz		8.0	
hFE	Forward Current Transfer Ratio: $V_{CE} = 8\text{ V}, I_C = 20\text{ mA}$		30	150	300
I_{CBO}	Collector Cutoff Current: $V_{CB} = 8\text{ V}$	μA			0.2
I_{EBO}	Emitter Cutoff Current: $V_{EB} = 1\text{ V}$	μA			1.0
CCB	Collector Base Capacitance ¹ : $V_{CB} = 8\text{ V}, f = 1\text{ MHz}$	pF		0.5	

Note: 1. For this test, the emitter is grounded.

AT-00510 General Purpose Silicon Bipolar Transistor

Absolute Maximum Ratings

Parameter	Symbol	Absolute Maximum
Emitter-Base Voltage	V_{EBO}	1.5 V
Collector-Base Voltage	V_{CBO}	20 V
Collector-Emitter Voltage	V_{CEO}	12 V
Collector Current	I_C	50 mA
Power Dissipation ^{2,3}	P_T	500 mW
Junction Temperature	T_j	200°C
Storage Temperature	T_{STG}	-65°C to 200°C

Thermal Resistance^{2,4}: $\theta_{jc} = 150^\circ\text{C/W}$

Notes:

1. Operation of this device above any one of these parameters may cause permanent damage.
2. $T_{CASE} = 25^\circ\text{C}$.
3. Derate at 6.7 mW/°C for $T_C > 125^\circ\text{C}$.
4. The small spot size of this technique results in a higher, though more accurate determination of θ_{jc} than do alternate methods. See MEASUREMENTS section "Thermal Resistance" for more information.

Typical Performance, $T_A = 25^\circ\text{C}$

(unless otherwise noted)

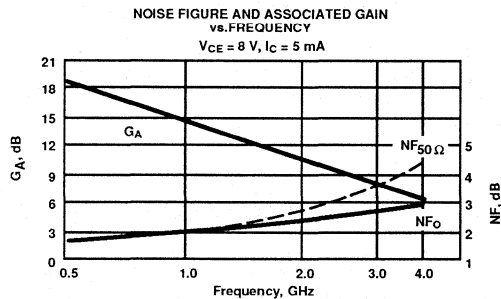
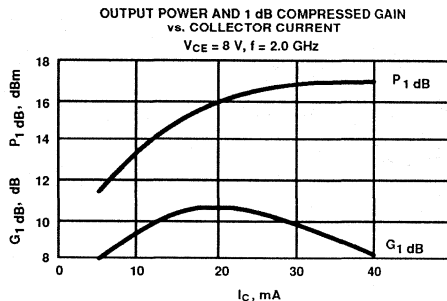
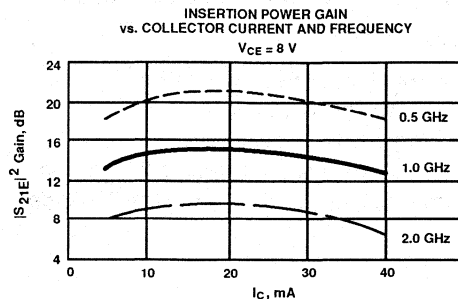

Typical Scattering Parameters: Common Emitter, $Z_o = 50\ \Omega$

$T_A = 25^\circ\text{C}, V_{CE} = 8\text{ V}, I_C = 5\text{ mA}$

Freq. GHz	S_{11}		S_{21}			S_{12}			S_{22}	
	Mag	Ang	dB	Mag	Ang	dB	Mag	Ang	Mag	Ang
0.1	.75	-31	23.3	14.61	160	-31.7	.026	81	.95	-16
0.5	.60	-112	18.3	8.22	111	-23.0	.071	42	.58	-51
1.0	.54	-152	13.4	4.65	85	-21.4	.085	33	.41	-63
1.5	.52	-173	10.2	3.24	69	-20.1	.099	33	.36	-70
2.0	.52	171	7.9	2.49	55	-19.2	.109	33	.35	-77
2.5	.53	163	6.3	2.07	47	-17.8	.128	35	.33	-81
3.0	.55	153	4.9	1.75	36	-17.1	.139	36	.34	-90
3.5	.55	143	3.8	1.54	24	-16.1	.157	32	.36	-101
4.0	.55	134	2.7	1.37	13	-15.4	.170	30	.38	-111
4.5	.55	123	1.9	1.24	3	-14.4	.190	25	.40	-121
5.0	.55	111	1.1	1.14	8	-13.7	.206	20	.42	-131

$T_A = 25^\circ\text{C}, V_{CE} = 8\text{ V}, I_C = 20\text{ mA}$

Freq. GHz	S_{11}		S_{21}			S_{12}			S_{22}	
	Mag	Ang	dB	Mag	Ang	dB	Mag	Ang	Mag	Ang
0.1	.47	-71	29.7	30.66	145	-34.4	.019	63	.83	-30
0.5	.52	-156	20.8	10.90	97	-27.7	.041	51	.34	-66
1.0	.53	-179	15.1	5.68	78	-24.7	.058	52	.24	-72
1.5	.52	167	11.8	3.87	65	-21.4	.085	55	.22	-76
2.0	.53	156	9.4	2.94	53	-19.6	.105	51	.22	-84
2.5	.54	151	7.7	2.42	46	-17.8	.128	51	.22	-88
3.0	.56	143	6.2	2.04	37	-16.7	.146	50	.23	-98
3.5	.56	135	5.0	1.78	26	-15.6	.165	44	.25	-107
4.0	.55	126	4.0	1.59	16	-14.6	.186	39	.27	-117
4.5	.55	117	3.2	1.44	6	-13.7	.206	32	.30	-126
5.0	.56	105	2.4	1.32	-4	-13.0	.223	26	.31	-135

A model for this device is available in the DEVICE MODELS section.

Features

- 16.0 dBm typical P_1 dB at 2.0 GHz
- 10.5 dB typical G_1 dB at 2.0 GHz
- 2.5 dB typical NF_0 at 2.0 GHz
- High Gain-Bandwidth Product: 8.0 GHz typical f_T
- Cost Effective Ceramic Microstrip Package

Description

Avantek's AT-00535 is a high performance NPN silicon bipolar transistor housed in a cost effective, microstrip package. This device is designed for use in wide band amplifier and oscillator applications operating over VHF, UHF and microwave frequencies.

Excellent device uniformity, performance and reliability are produced by the use of ion-implantation, self-alignment techniques, and gold metallization in the fabrication of these devices.

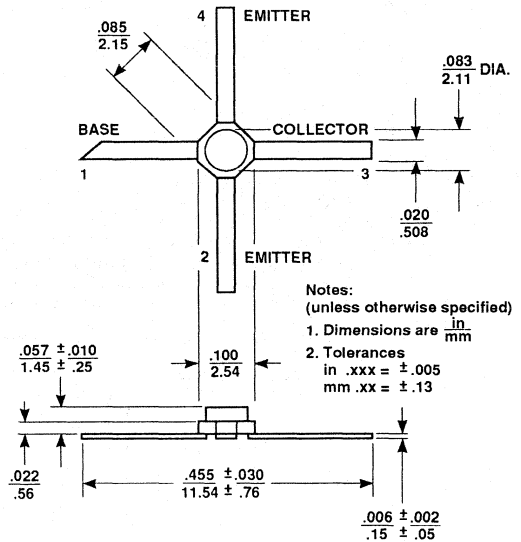
Avantek 35 micro-X Package

INSERTION POWER GAIN, MAXIMUM AVAILABLE
 GAIN AND MAXIMUM STABLE GAIN
 vs. FREQUENCY
 $V_{CE} = 8\text{ V}, I_C = 20\text{ mA}$

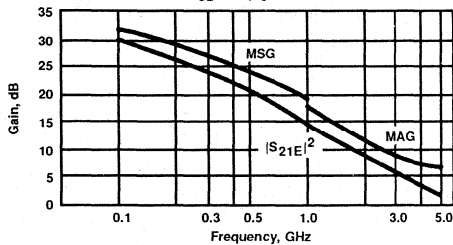
Electrical Specifications, $T_A = 25^\circ\text{C}$

Symbol	Parameters and Test Conditions	Units	Min.	Typ.	Max.
$ S_{21E} ^2$	Insertion Power Gain: $V_{CE} = 8\text{ V}, I_C = 20\text{ mA}$ $f = 1.0\text{ GHz}$ $f = 2.0\text{ GHz}$	dB	13.0	15.0 9.0	
P_1 dB	Power Output @ 1 dB Gain Compression: $V_{CE} = 8\text{ V}, I_C = 20\text{ mA}$ $f = 2.0\text{ GHz}$	dBm		16.0	
G_1 dB	1 dB Compressed Gain: $V_{CE} = 8\text{ V}, I_C = 20\text{ mA}$ $f = 2.0\text{ GHz}$	dB		10.5	
NF_0	Optimum Noise Figure: $V_{CE} = 8\text{ V}, I_C = 5\text{ mA}$ $f = 2.0\text{ GHz}$	dB		2.5	
GA	Gain @ NF_0 : $V_{CE} = 8\text{ V}, I_C = 5\text{ mA}$ $f = 2.0\text{ GHz}$	dB		10.5	
f_T	Gain Bandwidth Product: $V_{CE} = 8\text{ V}, I_C = 20\text{ mA}$	GHz		8.0	
hFE	Forward Current Transfer Ratio: $V_{CE} = 8\text{ V}, I_C = 20\text{ mA}$		30	150	300
I_{CBO}	Collector Cutoff Current: $V_{CB} = 8\text{ V}$	μA			0.2
I_{EBO}	Emitter Cutoff Current: $V_{EB} = 1\text{ V}$	μA			1.0
C _{CB}	Collector Base Capacitance ¹ : $V_{CB} = 8\text{ V}, f = 1\text{ MHz}$	pF		0.5	

Note: 1. For this test, the emitter is grounded.

AT-00535 Low Noise Silicon Bipolar Transistor

Absolute Maximum Ratings

Parameter	Symbol	Absolute Maximum ¹
Emitter-Base Voltage	VEBO	1.5 V
Collector-Base Voltage	VCBO	20 V
Collector-Emitter Voltage	VCEO	12 V
Collector Current	IC	50 mA
Power Dissipation ^{2,3}	PT	500 mW
Junction Temperature	TJ	200°C
Storage Temperature ⁴	TSTG	-65°C to 200°C

Thermal Resistance^{2,5}: $\theta_{jc} = 180^\circ\text{C/W}$

Notes:

1. Operation of this device above any one of these parameters may cause permanent damage.
2. TCASE = 25°C.
3. Derate at 5.6 mW/°C for TCASE > 110°C.
4. Storage above 150°C may tarnish the leads of this package making it difficult to solder into a circuit. After a device has been soldered into a circuit, it may be safely stored up to 200°C.
5. The small spot size of this technique results in a higher, though more accurate determination of θ_{jc} than do alternate methods. See MEASUREMENTS section "Thermal Resistance" for more information.

Typical Performance, TA = 25°C

(unless otherwise noted)

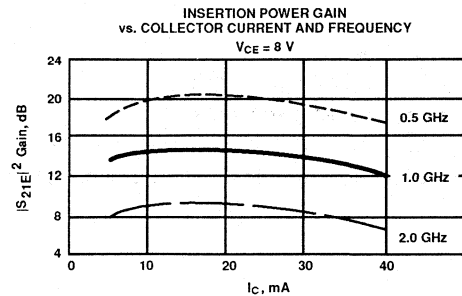

OUTPUT POWER AND 1 dB COMPRESSED GAIN
vs. COLLECTOR CURRENT
VCE = 8 V, f = 2.0 GHz

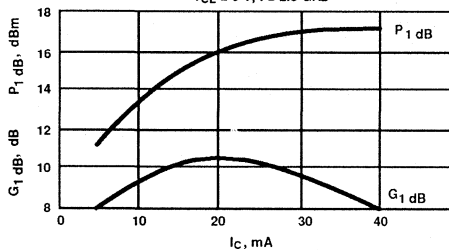

NOISE FIGURE AND ASSOCIATED GAIN
vs. FREQUENCY
VCE = 8 V, IC = 5 mA

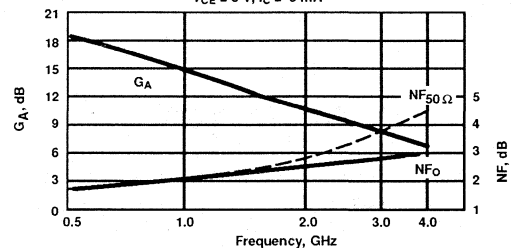

Typical Scattering Parameters: Common Emitter, ZO = 50 Ω

TA = 25°C, VCE = 8 V, IC = 5 mA

Freq. GHz	S11		dB	S21		dB	S12		S22	
	Mag	Ang		Mag	Ang		Mag	Ang	Mag	Ang
0.1	.82	-29	23.4	14.90	159	-33.1	.022	69	.95	-16
0.5	.58	-106	18.3	8.20	110	-23.4	.068	44	.58	-47
1.0	.49	-149	13.4	4.67	83	-20.9	.090	37	.41	-57
1.5	.48	-175	10.3	3.28	66	-19.6	.105	39	.35	-64
2.0	.49	167	8.1	2.53	52	-18.1	.125	37	.32	-74
2.5	.50	156	6.4	2.10	43	-17.0	.141	41	.31	-82
3.0	.53	144	5.0	1.78	31	-15.9	.160	39	.30	-97
3.5	.54	134	3.9	1.56	19	-15.0	.178	36	.34	-110
4.0	.54	124	2.8	1.38	8	-13.9	.202	34	.37	-120
4.5	.55	112	2.0	1.25	-3	-12.8	.229	29	.39	-129
5.0	.56	98	1.2	1.15	-15	-11.9	.253	23	.40	-139

TA = 25°C, VCE = 8 V, IC = 20 mA

0.1	.56	-63	29.6	30.24	143	-34.4	.019	62	.81	-28
0.5	.47	-150	20.3	10.37	96	-27.3	.043	54	.36	-52
1.0	.47	-178	14.7	5.43	76	-23.4	.068	56	.27	-54
1.5	.48	165	11.4	3.71	62	-20.4	.095	57	.24	-61
2.0	.50	152	9.1	2.84	49	-18.3	.121	53	.23	-72
2.5	.51	145	7.3	2.33	41	-16.7	.146	53	.21	-82
3.0	.54	135	5.9	1.96	31	-15.5	.167	50	.23	-98
3.5	.56	126	4.7	1.72	20	-14.2	.194	44	.26	-113
4.0	.56	116	3.7	1.53	9	-13.2	.219	40	.29	-123
4.5	.55	106	2.8	1.38	-2	-12.2	.244	32	.32	-131
5.0	.57	93	2.1	1.27	-13	-11.3	.273	25	.33	-141

A model for this device is available in the DEVICE MODELS section.

Features

- 16.0 dBm typical P_1 dB at 2.0 GHz
- 11.5 dB typical G_1 dB at 2.0 GHz
- 2.5 dB typical NF_0 at 2.0 GHz
- High Gain-Bandwidth Product: 8.0 GHz typical f_T
- Hermetic Gold-ceramic Microstrip Package

Description

Avantek's AT-00570 is a high performance NPN silicon bipolar transistor housed in a hermetic, high reliability package. This device is designed for use in wide band amplifier and oscillator applications operating over VHF, UHF and microwave frequencies.

Excellent device uniformity, performance and reliability are produced by the use of ion-implantation, self-alignment techniques, and gold metallization in the fabrication of these devices.

Avantek 70 mil Package

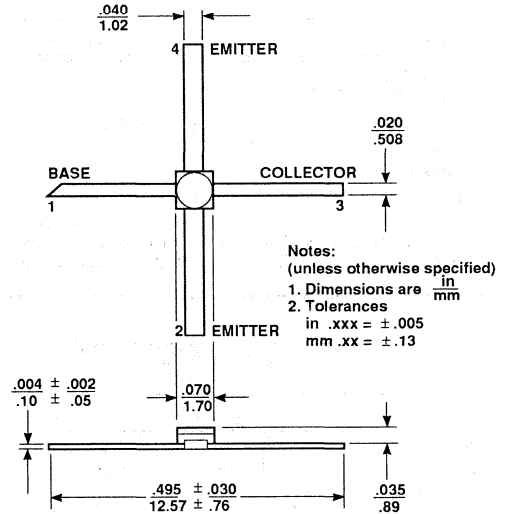

INSERTION POWER GAIN MAXIMUM AVAILABLE
GAIN AND MAXIMUM STABLE GAIN vs. FREQUENCY
 $V_{CE} = 8 \text{ V}, I_C = 20 \text{ mA}$

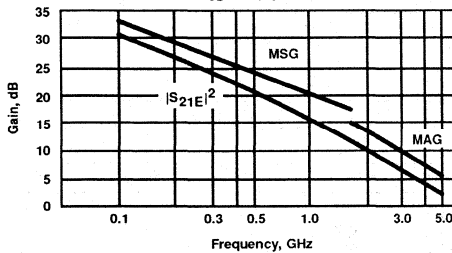

Electrical Specifications, $T_A = 25^\circ\text{C}$

Symbol	Parameters and Test Conditions	Units	Min.	Typ.	Max.
$ S_{21E} ^2$	Insertion Power Gain: $V_{CE} = 8 \text{ V}, I_C = 20 \text{ mA}$ $f = 1.0 \text{ GHz}$ $f = 2.0 \text{ GHz}$	dB	14.0	15.5 9.5	
P_1 dB	Power Output @ 1 dB Gain Compression: $V_{CE} = 8 \text{ V}, I_C = 20 \text{ mA}$ $f = 2.0 \text{ GHz}$	dBm		16.0	
G_1 dB	1 dB Compressed Gain: $V_{CE} = 8 \text{ V}, I_C = 20 \text{ mA}$ $f = 2.0 \text{ GHz}$	dB		11.5	
NF_0	Optimum Noise Figure: $V_{CE} = 8 \text{ V}, I_C = 5 \text{ mA}$ $f = 2.0 \text{ GHz}$	dB		2.5	
G_A	Gain @ NF_0 : $V_{CE} = 8 \text{ V}, I_C = 5 \text{ mA}$ $f = 2.0 \text{ GHz}$	dB		10.5	
f_T	Gain Bandwidth Product: $V_{CE} = 8 \text{ V}, I_C = 20 \text{ mA}$	GHz		8.0	
hFE	Forward Current Transfer Ratio: $V_{CE} = 8 \text{ V}, I_C = 20 \text{ mA}$		30	150	300
I_{CBO}	Collector Cutoff Current: $V_{CB} = 8 \text{ V}$	μA			0.2
I_{EBO}	Emitter Cutoff Current: $V_{EB} = 1 \text{ V}$	μA			1.0
CCB	Collector Base Capacitance ¹ : $V_{CB} = 8 \text{ V}, f = 1 \text{ MHz}$	pF		0.5	

Note: 1. For this test, the emitter is grounded.

Absolute Maximum Ratings

Parameter	Symbol	Absolute Maximum ¹
Emitter-Base Voltage	VEBO	1.5 V
Collector-Base Voltage	VCBO	20 V
Collector-Emitter Voltage	VCEO	12 V
Collector Current	IC	50 mA
Power Dissipation ^{2,3}	PT	500 mW
Junction Temperature	Tj	200°C
Storage Temperature	TSTG	-65°C to 200°C

Thermal Resistance^{2,4}: $\theta_{jc} = 155^\circ\text{C/W}$

Notes:

1. Operation of this device above any one of these parameters may cause permanent damage.
2. TCASE = 25°C.
3. Derate at 6.5 mW/°C for $T_C > 123^\circ\text{C}$.
4. The small spot size of this technique results in a higher, though more accurate determination of θ_{jc} than do alternate methods. See MEASUREMENTS section "Thermal Resistance" for more information.

Typical Performance, TA = 25°C

(unless otherwise noted)

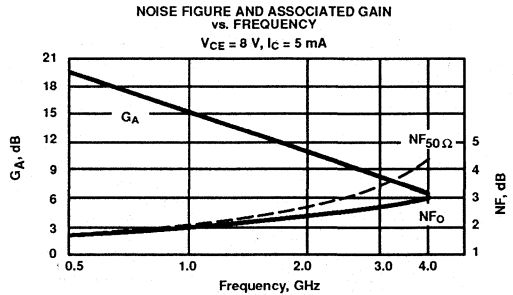
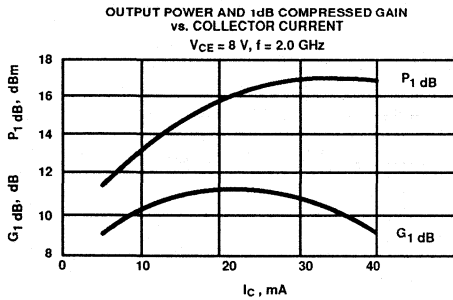
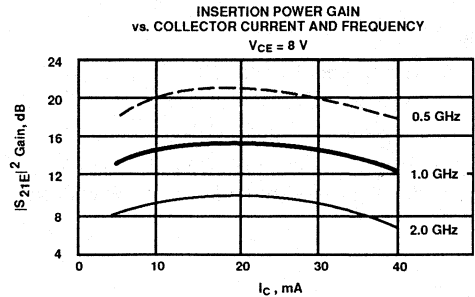

Typical Scattering Parameters: Common Emitter, ZO = 50 Ω

TA = 25°C, VCE = 8 V, IC = 5 mA

Freq. GHz	S11			S21			S12			S22		
	Mag	Ang	dB	Mag	Ang	dB	Mag	Ang	dB	Mag	Ang	
0.1	.82	-29	23.4	14.78	160	-33.1	.022	83	.95	-15		
0.5	.64	-106	18.5	8.41	113	-23.5	.067	40	.59	-49		
1.0	.57	-144	13.6	4.79	88	-21.2	.087	33	.42	-60		
1.5	.55	-164	10.5	3.35	73	-20.4	.096	33	.38	-66		
2.0	.54	-178	8.2	2.57	60	-19.5	.106	32	.36	-74		
2.5	.54	175	6.6	2.13	53	-18.4	.120	35	.36	-78		
3.0	.54	167	5.0	1.79	43	-17.7	.130	36	.37	-87		
3.5	.54	159	3.8	1.56	32	-17.2	.138	33	.40	-97		
4.0	.53	153	2.8	1.38	22	-16.3	.153	31	.44	-104		
4.5	.52	145	1.9	1.24	13	-15.6	.166	28	.47	-110		
5.0	.50	135	1.1	1.13	4	-14.9	.180	24	.49	-117		

TA = 25°C, VCE = 8 V, IC = 20 mA

0.1	.57	-68	30.2	32.27	145	-37.1	.014	64	.82	-30
0.5	.56	-151	21.0	11.22	98	-28.4	.038	47	.34	-62
1.0	.55	-173	15.3	5.84	80	-24.7	.058	53	.26	-68
1.5	.55	175	12.0	3.96	68	-22.6	.074	55	.25	-71
2.0	.54	165	9.6	3.00	57	-20.9	.090	52	.26	-78
2.5	.55	161	7.8	2.45	52	-19.0	.112	54	.27	-81
3.0	.55	156	6.3	2.06	43	-18.2	.123	51	.29	-90
3.5	.55	149	5.0	1.78	34	-17.0	.141	48	.33	-98
4.0	.54	144	3.9	1.57	25	-16.0	.159	43	.36	-103
4.5	.52	137	3.1	1.42	16	-15.1	.176	39	.40	-108
5.0	.50	128	2.3	1.30	8	-14.3	.192	35	.41	-112

A model for this device is available in the DEVICE MODELS section.

Features

- 19.0 dBm typical P_1 dB at 1.0 GHz
- 6.0 dB typical G_1 dB at 1.0 GHz
- 2.3 dB typical NF_0 at 1.0 GHz
- High Gain-Bandwidth Product: 6.5 GHz typical f_T
- Hermetic, Metal Package

Description

Avantek's AT-00572 is a high performance NPN silicon bipolar transistor housed in a hermetic high reliability metal package. This device is designed for use in wide band amplifier and oscillator applications operating over VHF, UHF and microwave frequencies.

Excellent device uniformity, performance and reliability are produced by the use of ion-implantation, self-alignment techniques, and gold metallization in the fabrication of these devices.

Avantek TO-72 Package

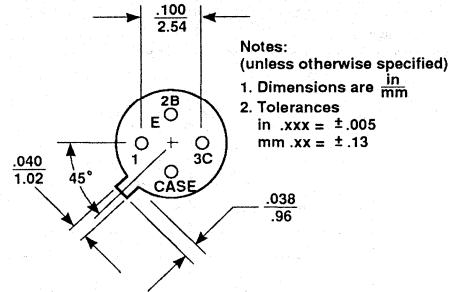
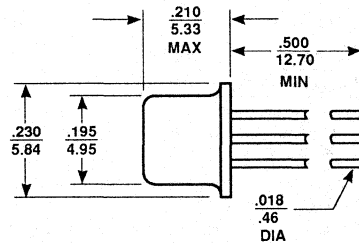

INSERTION POWER GAIN, MAXIMUM AVAILABLE GAIN AND MAXIMUM STABLE GAIN vs. FREQUENCY
 $V_{CE} = 8 \text{ V}, I_C = 20 \text{ mA}$

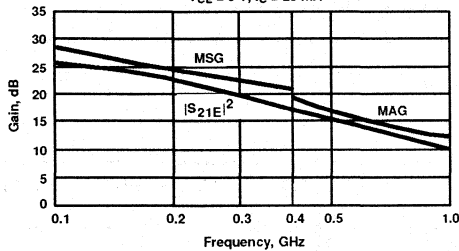

Electrical Specifications, $T_A = 25^\circ\text{C}$

Symbol	Parameters and Test Conditions	Units	Min.	Typ.	Max.
$ S_{21E} ^2$	Insertion Power Gain: $V_{CE} = 8 \text{ V}, I_C = 20 \text{ mA}$ $f = 0.5 \text{ GHz}$ $f = 1.0 \text{ GHz}$	dB	14.0	15.5 10.0	
P_1 dB	Power Output @ 1 dB Gain Compression: $V_{CE} = 8 \text{ V}, I_C = 20 \text{ mA}$ $f = 1.0 \text{ GHz}$	dBm		19.0	
G_1 dB	1 dB Compressed Gain: $V_{CE} = 8 \text{ V}, I_C = 20 \text{ mA}$ $f = 1.0 \text{ GHz}$	dB		6.0	
NF_0	Optimum Noise Figure: $V_{CE} = 8 \text{ V}, I_C = 5 \text{ mA}$ $f = 0.5 \text{ GHz}$ $f = 1.0 \text{ GHz}$	dB		1.9 2.3	
G_A	Gain @ NF_0 : $V_{CE} = 8 \text{ V}, I_C = 5 \text{ mA}$ $f = 0.5 \text{ GHz}$ $f = 1.0 \text{ GHz}$	dB		12.0 8.5	
f_T	Gain Bandwidth Product: $V_{CE} = 8 \text{ V}, I_C = 20 \text{ mA}$	GHz		6.5	
h_{FE}	Forward Current Transfer Ratio: $V_{CE} = 8 \text{ V}, I_C = 20 \text{ mA}$		30	150	300
I_{CBO}	Collector Cutoff Current: $V_{CB} = 8 \text{ V}$	μA			0.2
I_{EBO}	Emitter Cutoff Current: $V_{EB} = 1 \text{ V}$	μA			1.0
C_{CB}	Collector Base Capacitance ¹ : $V_{CE} = 8 \text{ V}, f = 1 \text{ MHz}$	pF		0.65	

Note: 1. For this test, the emitter is grounded.

AT-00572 General Purpose Silicon Bipolar Transistor

Absolute Maximum Ratings

Parameter	Symbol	Absolute Maximum ¹
Emitter-Base Voltage	VEBO	1.5 V
Collector-Base Voltage	VCBO	20 V
Collector-Emitter Voltage	VCEO	12 V
Collector Current	IC	50 mA
Power Dissipation ^{2,3}	PT	500 mW
Junction Temperature	Tj	200°C
Storage Temperature	TSTG	-65°C to 200°C

Thermal Resistance^{2,4}: $\theta_{jc} = 235^\circ\text{C/W}$

Notes:

- Operation of this device above any one of these parameters may cause permanent damage.
- TCASE = 25°C.
- Derate at 4.3 mW/°C for $T_C > 83^\circ\text{C}$.
- The small spot size of this technique results in a higher, though more accurate determination of θ_{jc} than do alternate methods. See MEASUREMENTS section "Thermal Resistance" for more information.

Typical Performance, $T_A = 25^\circ\text{C}$

(unless otherwise noted)

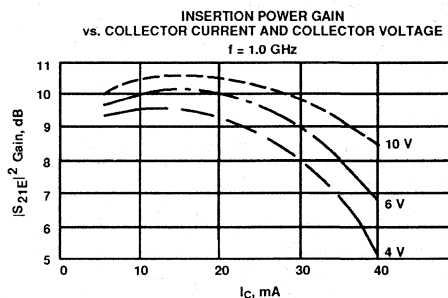
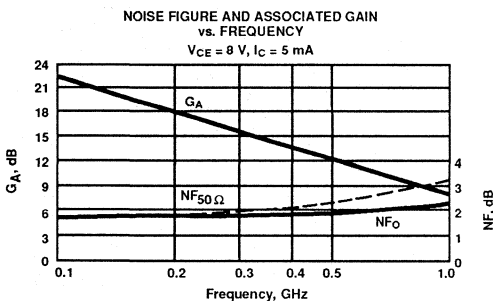
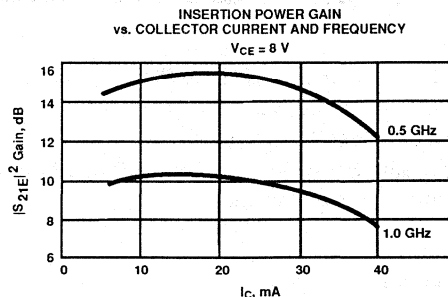

Typical Scattering Parameters: Common Emitter, $Z_0 = 50\ \Omega$

$T_A = 25^\circ\text{C}, V_{CE} = 8\text{ V}, I_C = 5\text{ mA}$

Freq. GHz	S_{11}		dB	S_{21}		dB	S_{12}		S_{22}	
	Mag	Ang		Mag	Ang		Mag	Ang	Mag	Ang
0.1	.82	-22	19.1	8.99	150	-31.4	.027	75	.87	-19
0.2	.65	-40	18.7	8.57	129	-27.1	.044	72	.72	-27
0.3	.51	-54	17.6	7.55	116	-24.3	.061	69	.64	-30
0.4	.40	-61	16.0	6.29	103	-22.6	.074	66	.57	-30
0.5	.31	-65	14.6	5.34	94	-21.3	.086	65	.51	-31
0.6	.25	-70	13.5	4.73	91	-19.7	.103	67	.48	-35
0.7	.21	-73	12.4	4.17	84	-18.6	.118	65	.45	-39
0.8	.17	-76	11.6	3.81	79	-17.6	.131	64	.44	-43
0.9	.16	-81	10.5	3.37	76	-16.8	.145	65	.46	-47
1.0	.14	-83	10.0	3.14	72	-16.0	.158	64	.46	-48

$T_A = 25^\circ\text{C}, V_{CE} = 8\text{ V}, I_C = 20\text{ mA}$

0.1	.51	-39	25.7	19.28	131	-32.8	.023	77	.74	-21
0.2	.33	-51	22.3	12.96	110	-28.2	.039	77	.60	-24
0.3	.24	-58	19.6	9.50	100	-25.2	.055	77	.53	-26
0.4	.19	-58	17.3	7.28	91	-23.2	.069	74	.49	-24
0.5	.16	-57	15.4	5.91	85	-21.6	.084	72	.46	-25
0.6	.13	-57	14.1	5.09	83	-19.8	.102	73	.44	-29
0.7	.11	-56	13.0	4.44	78	-18.5	.119	70	.42	-33
0.8	.09	-59	12.1	4.02	74	-17.5	.134	69	.41	-37
0.9	.08	-64	10.9	3.52	72	-16.5	.149	70	.43	-42
1.0	.08	-64	10.3	3.29	68	-15.8	.163	68	.44	-44

Features

- 22.0 dBm typical $P_{1\text{ dB}}$ at 2.0 GHz
- 10.5 dB typical $G_{1\text{ dB}}$ at 2.0 GHz
- High Gain-Bandwidth Product: 8.0 GHz typical f_T

Description

Avantek's AT-01600 is a high performance NPN silicon bipolar transistor chip designed for use in medium power, wide band amplifier and oscillator applications operating over VHF, UHF and microwave frequencies.

The die are nitride-passivated for surface protection. Excellent device uniformity, performance and reliability are produced by the use of ion-implantation, self-alignment techniques, and gold metallization in the fabrication of these devices.

The recommended assembly procedure is gold-eutectic die attach at 400°C and either wedge or ball bonding using 0.7 mil gold wire. See also "Chip Use" in the APPLICATIONS section.

Avantek Chip Outline

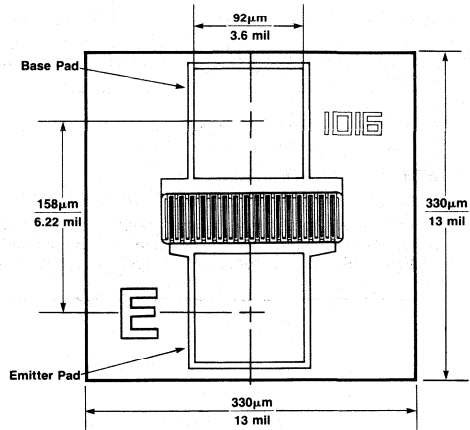

INSERTION POWER GAIN, MAXIMUM AVAILABLE GAIN AND MAXIMUM STABLE GAIN vs. FREQUENCY
 $V_{CE} = 8\text{ V}, I_C = 35\text{ mA}$

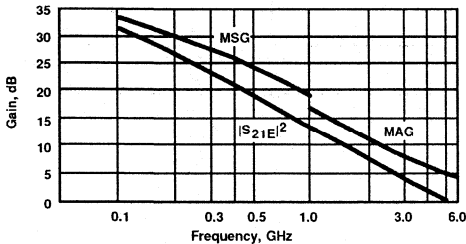

Electrical Specifications, $T_A = 25^\circ\text{C}$

Symbol	Parameters and Test Conditions ¹	Units	Min.	Typ.	Max.
$ S_{21E} ^2$	Insertion Power Gain: $V_{CE} = 8\text{ V}, I_C = 35\text{ mA}$ $f = 1.0\text{ GHz}$ $f = 2.0\text{ GHz}$	dB		13.0 7.0	
$P_{1\text{ dB}}$	Power Output @ 1 dB Gain Compression: $V_{CE} = 8\text{ V}, I_C = 60\text{ mA}$ $f = 2.0\text{ GHz}$	dBm		22.0	
$G_{1\text{ dB}}$	1 dB Compressed Gain: $V_{CE} = 8\text{ V}, I_C = 60\text{ mA}$ $f = 2.0\text{ GHz}$	dB		10.5	
NFO	Optimum Noise Figure: $V_{CE} = 8\text{ V}, I_C = 35\text{ mA}$ $f = 2.0\text{ GHz}$	dB		3.0	
G_A	Gain @ NFO: $V_{CE} = 8\text{ V}, I_C = 35\text{ mA}$ $f = 2.0\text{ GHz}$	dB		10.5	
f_T	Gain Bandwidth Product: $V_{CE} = 8\text{ V}, I_C = 35\text{ mA}$	GHz		8.0	
h_{FE}	Forward Current Transfer Ratio: $V_{CE} = 8\text{ V}, I_C = 35\text{ mA}$		30	150	300
I_{CBO}	Collector Cutoff Current: $V_{CB} = 8\text{ V}$	μA			0.2
I_{EBO}	Emitter Cutoff Current: $V_{EB} = 1\text{ V}$	μA			2.0
CCB	Collector Base Capacitance ² : $V_{CB} = 8\text{ V}, f = 1\text{ MHz}$	pF		0.75	

Notes: 1. RF performance is determined by packaging and testing 10 devices per wafer.
 2. For this test, the emitter is grounded.

AT-01600 General Purpose Silicon Bipolar Transistor

Absolute Maximum Ratings

Parameter	Symbol	Absolute Maximum ¹
Emitter-Base Voltage	VEBO	1.5 V
Collector-Base Voltage	VCBO	20 V
Collector-Emitter Voltage	VCEO	12 V
Collector Current	IC	150 mA
Power Dissipation ^{2,3}	PT	1000 mW
Junction Temperature	Tj	200°C
Storage Temperature	TSTG	-65°C to 200°C

Thermal Resistance^{2,4}: $\theta_{jC} = 40^\circ\text{C}/\text{W}$

Notes:

1. Operation of this device above any one of these parameters may cause permanent damage.
2. T_{MOUNTING SURFACE} = 25°C.
3. Derate at 25 mW/°C for T_{MOUNTING SURFACE} > 160°C.
4. The small spot size of this technique results in a higher, though more accurate determination of θ_{jC} than do alternate methods. See MEASUREMENTS section "Thermal Resistance" for more information.

Part Number Ordering Information

Part Number	Devices Per Tray
AT-01600-GP2	10
AT-01600-GP4	100
AT-01600-GP6	up to 300

Typical Performance, T_A = 25°C

(unless otherwise noted)

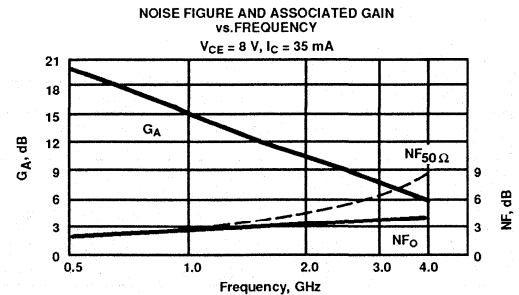
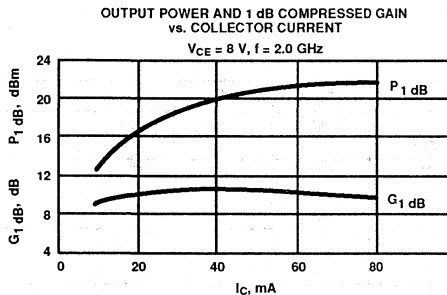
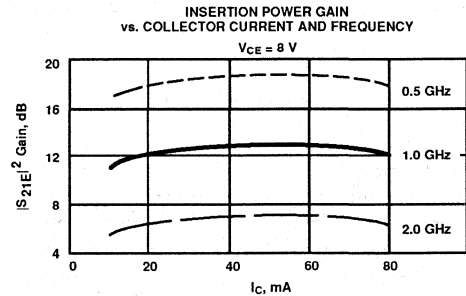
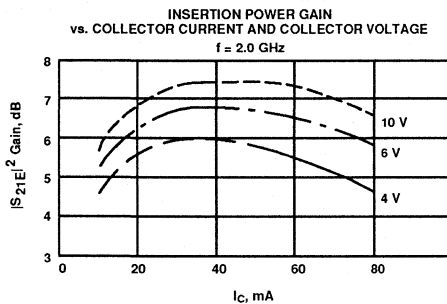

AT-01600
General Purpose Silicon Bipolar Transistor

Typical Scattering Parameters: Common Emitter, $Z_0 = 50 \Omega$

$T_A = 25^\circ\text{C}$, $V_{CE} = 8 \text{ V}$, $I_C = 35 \text{ mA}$

Freq. GHz	S ₁₁		S ₂₁			S ₁₂			S ₂₂	
	Mag	Ang	dB	Mag	Ang	dB	Mag	Ang	Mag	Ang
0.1	.67	-124	31.1	35.75	123	-34.0	.020	47	55	-71
0.5	.72	-172	18.7	8.64	90	-29.1	.035	53	24	-128
1.0	.72	175	13.0	4.45	81	-24.9	.057	65	22	-141
1.5	.72	169	9.4	2.94	73	-21.9	.080	69	22	-143
2.0	.73	163	7.2	2.29	66	-19.7	.103	71	22	-141
2.5	.72	160	5.4	1.86	60	-18.1	.124	72	24	-139
3.0	.74	155	4.0	1.58	53	-16.6	.148	70	25	-136
3.5	.73	150	2.9	1.40	49	-15.4	.170	71	27	-135
4.0	.75	145	1.7	1.22	43	-14.0	.187	69	29	-135
4.5	.75	141	0.8	1.10	39	-13.6	.210	69	32	-133
5.0	.75	139	-0.2	0.98	35	-13.0	.225	67	35	-132
5.5	.76	134	-0.7	0.92	29	-12.3	.242	67	38	-133
6.0	.76	130	-1.7	0.82	26	-11.7	.261	66	42	-134

$T_A = 25^\circ\text{C}$, $V_{CE} = 8 \text{ V}$, $I_C = 60 \text{ mA}$

0.1	.65	-146	31.6	38.06	119	-37.0	.014	48	50	-77
0.5	.74	-178	19.0	8.94	90	-30.8	.029	65	22	-134
1.0	.75	173	13.0	4.44	80	-25.7	.052	72	21	-142
1.5	.75	168	9.5	2.99	73	-22.5	.075	76	22	-142
2.0	.74	163	7.0	2.24	66	-20.4	.096	75	23	-139
2.5	.75	157	5.4	1.86	62	-18.3	.121	76	25	-137
3.0	.76	154	3.9	1.56	55	-16.8	.144	75	27	-134
3.5	.75	150	2.7	1.36	50	-15.8	.162	75	29	-133
4.0	.75	146	1.7	1.21	48	-14.8	.183	76	32	-129
4.5	.76	143	0.5	1.06	42	-14.0	.200	74	34	-130
5.0	.77	139	-0.2	0.98	39	-13.1	.221	74	36	-127
5.5	.76	137	-1.0	0.89	35	-12.3	.243	73	39	-127
6.0	.75	132	-1.6	0.83	31	-11.6	.262	71	42	-126

A model for this device is available in the DEVICE MODELS section.

Features

- 22.0 dBm typical $P_{1\text{ dB}}$ at 2.0 GHz
- 9.5 dB typical $G_{1\text{ dB}}$ at 2.0 GHz
- High Gain-Bandwidth Product: 7.0 GHz typical f_T
- Hermetic Gold-ceramic Microstrip Package

Description

Avantek's AT-01610 is a high performance NPN silicon bipolar transistor housed in a hermetic, high reliability package. This device is designed for use in medium power, wide band amplifier applications operating over VHF, UHF and microwave frequencies.

Excellent device uniformity, performance and reliability are produced by the use of ion-implantation, self-alignment techniques, and gold metallization in the fabrication of these devices.

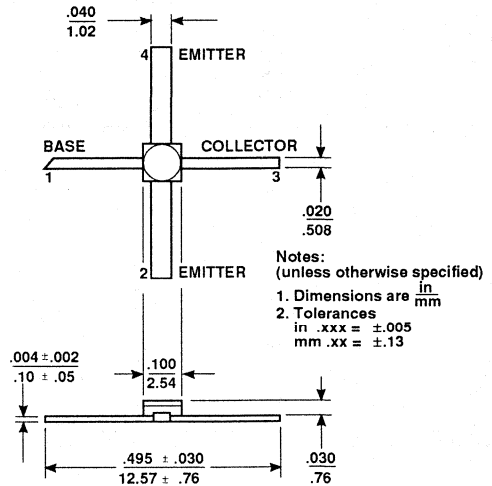
Avantek 100 mil Package

INSERTION POWER GAIN, MAXIMUM AVAILABLE
 GAIN AND MAXIMUM STABLE GAIN
 vs. FREQUENCY

$V_{CE} = 8\text{ V}, I_C = 35\text{ mA}$

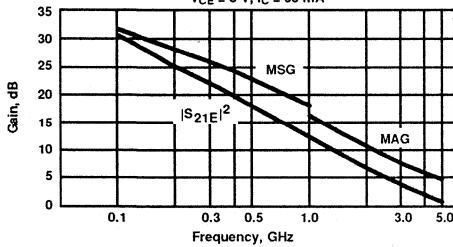
Electrical Specifications, $T_A = 25^\circ\text{C}$

Symbol	Parameters and Test Conditions	Units	Min.	Typ.	Max.
$ S_{21E} ^2$	Insertion Power Gain: $V_{CE} = 8\text{ V}, I_C = 35\text{ mA}$ $f = 1.0\text{ GHz}$ $f = 2.0\text{ GHz}$	dB	11.0	12.5 6.5	
$P_{1\text{ dB}}$	Power Output @ 1 dB Gain Compression: $V_{CE} = 8\text{ V}, I_C = 60\text{ mA}$ $f = 2.0\text{ GHz}$	dBm		22.0	
$G_{1\text{ dB}}$	1 dB Compressed Gain: $V_{CE} = 8\text{ V}, I_C = 60\text{ mA}$ $f = 2.0\text{ GHz}$	dB		9.5	
NFO	Optimum Noise Figure: $V_{CE} = 8\text{ V}, I_C = 35\text{ mA}$ $f = 2.0\text{ GHz}$	dB		3.0	
G_A	Gain @ NFO: $V_{CE} = 8\text{ V}, I_C = 35\text{ mA}$ $f = 2.0\text{ GHz}$	dB		10.0	
f_T	Gain Bandwidth Product: $V_{CE} = 8\text{ V}, I_C = 35\text{ mA}$	GHz		7.0	
h_{FE}	Forward Current Transfer Ratio: $V_{CE} = 8\text{ V}, I_C = 35\text{ mA}$		30	150	300
I_{CBO}	Collector Cutoff Current: $V_{CB} = 8\text{ V}$	μA			0.2
I_{EBO}	Emitter Cutoff Current: $V_{EB} = 1\text{ V}$	μA			2.0
CCB	Collector Base Capacitance ¹ : $V_{CB} = 8\text{ V}, f = 1\text{ MHz}$	pF		0.8	

Note: 1. For this test, the emitter is grounded.

Absolute Maximum Ratings

Parameter	Symbol	Absolute Maximum ¹
Emitter-Base Voltage	VEBO	1.5 V
Collector-Base Voltage	VCBO	20 V
Collector-Emitter Voltage	VCEO	12 V
Collector Current	IC	150 mA
Power Dissipation ^{2,3}	PT	1000 mW
Junction Temperature	Tj	200°C
Storage Temperature	TSTG	-65°C to 200°C

Thermal Resistance^{2,4}: $\theta_{jc} = 115^\circ\text{C}/\text{W}$

Notes:

1. Operation of this device above any one of these parameters may cause permanent damage.
2. TCASE = 25°C.
3. Derate at 8.7 mW/°C for TC > 85°C.
4. The small spot size of this technique results in a higher, though more accurate determination of θ_{jc} than do alternate methods. See MEASUREMENTS section "Thermal Resistance" for more information.

Typical Performance, TA = 25°C

(unless otherwise noted)

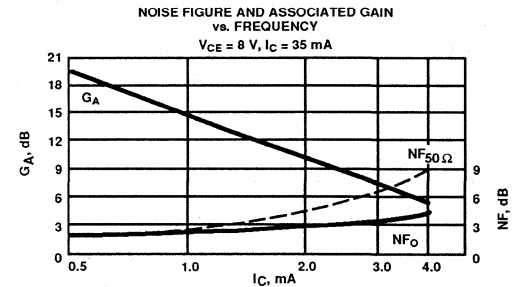
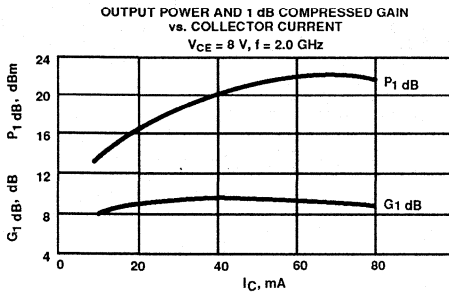
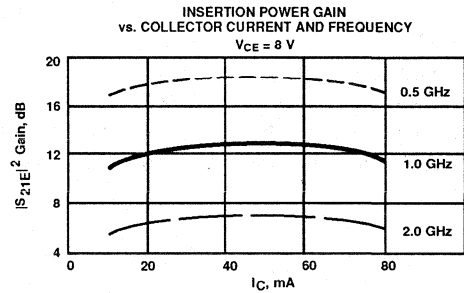

Typical Scattering Parameters: Common Emitter, ZO = 50 Ω

TA = 25°C, VCE = 8 V, IC = 35 mA

Freq. GHz	S11		S21			S12			S22	
	Mag	Ang	dB	Mag	Ang	dB	Mag	Ang	Mag	Ang
0.1	.69	-125	30.9	35.08	119	-33.6	.021	44	.53	-80
0.5	.72	-175	18.3	8.22	86	-28.4	.038	45	.28	-146
1.0	.71	171	12.4	4.17	72	-24.6	.059	50	.26	-162
1.5	.71	160	9.1	2.85	60	-21.8	.081	56	.24	-169
2.0	.72	151	6.7	2.16	49	-19.4	.107	50	.24	-174
2.5	.72	147	5.1	1.80	42	-17.8	.129	51	.25	-175
3.0	.73	140	3.8	1.55	32	-16.7	.147	47	.25	179
3.5	.73	132	2.8	1.37	22	-15.5	.168	41	.27	176
4.0	.72	124	1.8	1.23	11	-14.6	.187	36	.28	173
4.5	.72	114	0.9	1.11	1	-13.5	.211	30	.29	169
5.0	.73	103	0.1	1.01	-9	-12.9	.226	23	.30	163

TA = 25°C, VCE = 8 V, IC = 60 mA

0.1	.69	-138	31.5	37.69	114	-34.4	.019	42	.46	-92
0.5	.72	-178	18.4	8.34	85	-30.4	.030	60	.28	-154
1.0	.72	169	12.6	4.25	71	-24.6	.059	59	.25	-167
1.5	.72	159	9.3	2.91	60	-21.8	.081	59	.25	-173
2.0	.72	150	6.9	2.22	49	-19.3	.109	52	.24	-177
2.5	.72	146	5.2	1.83	42	-17.5	.133	54	.25	-179
3.0	.73	139	3.8	1.55	33	-16.6	.148	49	.26	176
3.5	.73	132	2.7	1.37	22	-15.4	.169	44	.27	174
4.0	.73	123	1.7	1.21	12	-14.4	.191	37	.29	171
4.5	.73	114	0.8	1.10	2	-13.5	.212	30	.30	166
5.0	.73	103	0.0	1.00	-8	-12.8	.228	24	.31	160

A model for this device is available in the DEVICE MODELS section.

Features

- 22.0 dBm typical P_1 dB at 2.0 GHz
- 9.5 dB typical G_1 dB at 2.0 GHz
- High Gain-Bandwidth Product: 7.0 GHz typical f_T
- Cost Effective Ceramic Microstrip Package

Description

Avantek's AT-01635 is a high performance NPN silicon bipolar transistor housed in a cost effective, microstrip package. This device is designed for use in medium power, wide band amplifier applications operating over VHF, UHF and microwave frequencies.

Excellent device uniformity, performance and reliability are produced by the use of ion-implantation, self-alignment techniques, and gold metallization in the fabrication of these devices.

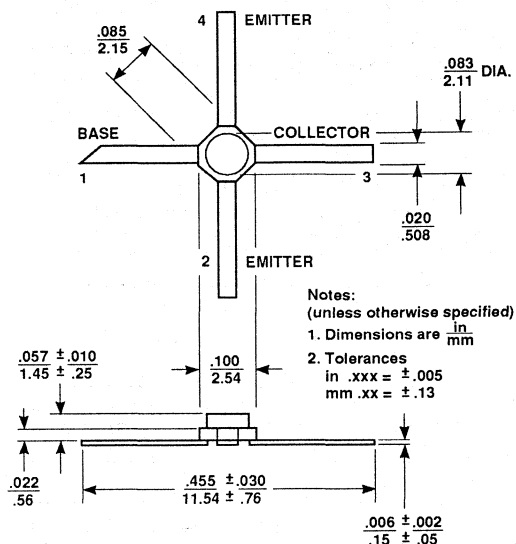
Avantek 35 micro-X Package

INSERTION POWER GAIN, MAXIMUM AVAILABLE GAIN AND MAXIMUM STABLE GAIN vs. FREQUENCY

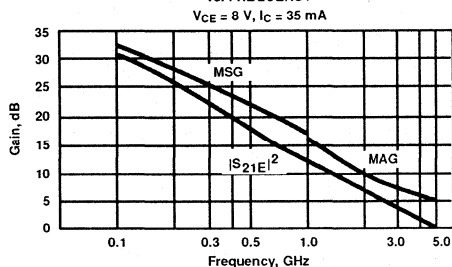
Electrical Specifications, $T_A = 25^\circ\text{C}$

Symbol	Parameters and Test Conditions	Units	Min.	Typ.	Max.
$ S_{21E} ^2$	Insertion Power Gain: $V_{CE} = 8$ V, $I_C = 35$ mA $f = 1.0$ GHz $f = 2.0$ GHz	dB	11.0	12.0 6.5	
P_1 dB	Power Output @ 1 dB Gain Compression: $V_{CE} = 8$ V, $I_C = 60$ mA $f = 2.0$ GHz	dBm		22.0	
G_1 dB	1 dB Compressed Gain: $V_{CE} = 8$ V, $I_C = 60$ mA $f = 2.0$ GHz	dB		9.5	
NF _O	Optimum Noise Figure: $V_{CE} = 8$ V, $I_C = 35$ mA $f = 2.0$ GHz	dB		3.0	
GA	Gain @ NF _O : $V_{CE} = 8$ V, $I_C = 35$ mA $f = 2.0$ GHz	dB		10.0	
f_T	Gain Bandwidth Product: $V_{CE} = 8$ V, $I_C = 35$ mA	GHz		7.0	
hFE	Forward Current Transfer Ratio: $V_{CE} = 8$ V, $I_C = 35$ mA		30	150	300
ICBO	Collector Cutoff Current: $V_{CB} = 8$ V	μA			0.2
IEBO	Emitter Cutoff Current: $V_{EB} = 1$ V	μA			2.0
CCB	Collector Base Capacitance ¹ : $V_{CE} = 8$ V, $f = 1$ MHz	pF		0.8	

Note: 1. For this test, the emitter is grounded.

Absolute Maximum Ratings

Parameter	Symbol	Absolute Maximum ¹
Emitter-Base Voltage	VEBO	1.5 V
Collector-Base Voltage	VCBO	20 V
Collector-Emitter Voltage	VCEO	12 V
Collector Current	IC	150 mA
Power Dissipation ^{2,3}	PT	1000 mW
Junction Temperature	TJ	200°C
Storage Temperature ⁴	TSTG	-65°C to 200°C

Thermal Resistance^{2,5}: $\theta_{JC} = 145^\circ\text{C}/\text{W}$

Notes:

1. Operation of this device above any one of these parameters may cause permanent damage.
2. TCASE = 25°C.
3. Derate at 6.9 mW/°C for TC > 55°C.
4. Storage above 150°C may tarnish the leads of this package making it difficult to solder into a circuit. After a device has been soldered into a circuit, it may be safely stored up to 200°C.
5. The small spot size of this technique results in a higher, though more accurate determination of θ_{JC} than do alternate methods. See MEASUREMENTS section "Thermal Resistance" for more information.

Typical Performance, TA = 25°C

(unless otherwise noted)

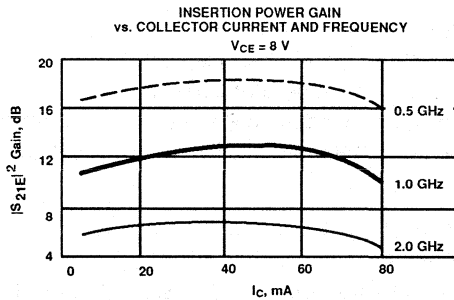

OUTPUT POWER AND 1dB COMPRESSED GAIN vs. COLLECTOR CURRENT
 VCE = 8 V, f = 2.0 GHz

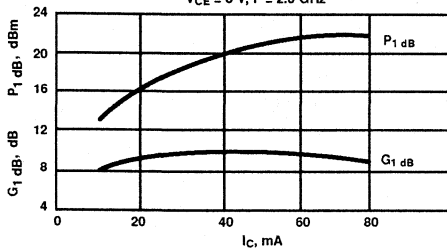

NOISE FIGURE AND ASSOCIATED GAIN vs. FREQUENCY
 VCE = 8 V, IC = 35 mA

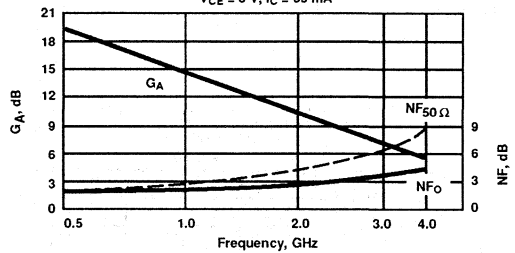

Typical Scattering Parameters: Common Emitter, ZO = 50 Ω

TA = 25°C, VCE = 8 V, IC = 35 mA

Freq. GHz	S11		S21			S12			S22		
	Mag	Ang	dB	Mag	Ang	dB	Mag	Ang	Mag	Ang	
0.1	.61	-119	30.6	33.90	119	-32.4	.024	52	.50	-69	
0.5	.62	-173	18.0	7.97	85	-26.0	.050	53	.20	-130	
1.0	.63	169	12.3	4.10	68	-21.4	.085	52	.18	-152	
1.5	.65	157	9.0	2.80	55	-19.0	.112	48	.18	-167	
2.0	.67	146	6.6	2.14	42	-17.1	.139	43	.20	-178	
2.5	.69	140	4.9	1.75	34	-15.7	.164	41	.23	176	
3.0	.71	132	3.4	1.47	23	-14.9	.180	36	.25	172	
3.5	.71	123	2.2	1.29	12	-13.9	.202	31	.28	169	
4.0	.71	115	1.2	1.15	2	-12.9	.226	25	.29	168	
4.5	.70	104	0.4	1.05	-8	-12.2	.246	19	.30	165	
5.0	.71	93	-0.3	0.97	-19	-11.4	.270	12	.30	158	

TA = 25°C, VCE = 8 V, IC = 60 mA

0.1	.60	-132	31.0	35.53	114	-35.4	.017	51	.42	-78
0.5	.64	-176	18.1	8.00	84	-27.0	.045	55	.20	-137
1.0	.66	167	12.3	4.11	68	-22.2	.077	55	.18	-160
1.5	.67	155	9.0	2.80	54	-19.7	.104	51	.19	-172
2.0	.68	144	6.5	2.12	41	-17.5	.133	46	.21	176
2.5	.70	138	4.8	1.73	34	-16.1	.157	45	.23	174
3.0	.71	130	3.3	1.46	23	-15.0	.178	40	.26	170
3.5	.72	122	2.1	1.27	13	-13.9	.203	33	.29	168
4.0	.71	114	1.1	1.13	2	-13.1	.221	28	.30	166
4.5	.71	104	0.4	1.04	-8	-12.1	.249	21	.30	163
5.0	.71	92	-0.3	0.95	-19	-11.4	.269	14	.31	156

A model for this device is available in the DEVICE MODELS section.

Features

- 22.0 dBm typical $P_{1\text{ dB}}$ at 2.0 GHz
- 10.5 dB typical $G_{1\text{ dB}}$ at 2.0 GHz
- High Gain-Bandwidth Product: 7.0 GHz typical f_T
- Hermetic Gold-ceramic Microstrip Package

Description

Avantek's AT-01670 is a high performance NPN silicon bipolar transistor housed in a hermetic, high reliability package. This device is designed for use in medium power, wide band amplifier applications operating over VHF, UHF and microwave frequencies.

Excellent device uniformity, performance and reliability are produced by the use of ion-implantation, self-alignment techniques, and gold metallization in the fabrication of these devices.

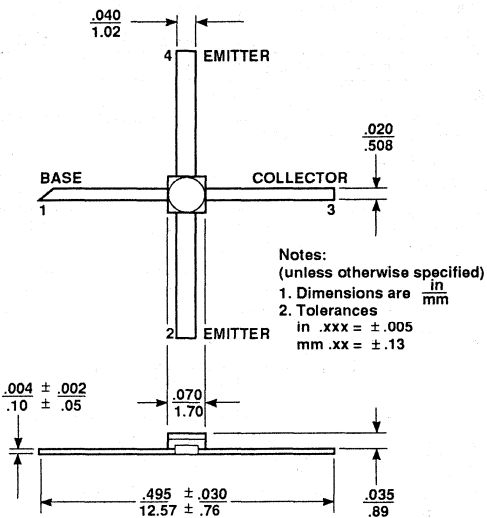
Avantek 70 mil Package

INSERTION POWER GAIN, MAXIMUM AVAILABLE GAIN AND MAXIMUM STABLE GAIN VS. FREQUENCY

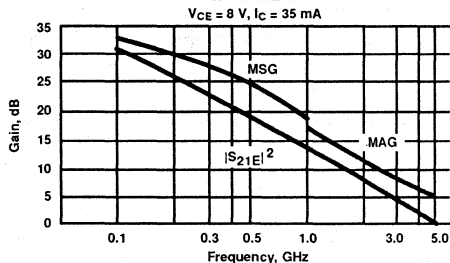
Electrical Specifications, $T_A = 25^\circ\text{C}$

Symbol	Parameters and Test Conditions	Units	Min.	Typ.	Max.
$ S_{21E} ^2$	Insertion Power Gain: $V_{CE} = 8\text{ V}, I_C = 35\text{ mA}$ $f = 1.0\text{ GHz}$ $f = 2.0\text{ GHz}$	dB	12.0	13.0 7.0	
$P_{1\text{ dB}}$	Power Output @ 1 dB Gain Compression: $V_{CE} = 8\text{ V}, I_C = 60\text{ mA}$ $f = 2.0\text{ GHz}$	dBm		22.0	
$G_{1\text{ dB}}$	1 dB Compressed Gain: $V_{CE} = 8\text{ V}, I_C = 60\text{ mA}$ $f = 2.0\text{ GHz}$	dB		10.5	
NF _O	Optimum Noise Figure: $V_{CE} = 8\text{ V}, I_C = 35\text{ mA}$ $f = 2.0\text{ GHz}$	dB		3.0	
GA	Gain @ NFO: $V_{CE} = 8\text{ V}, I_C = 35\text{ mA}$ $f = 2.0\text{ GHz}$	dB		10.5	
f_T	Gain Bandwidth Product: $V_{CE} = 8\text{ V}, I_C = 35\text{ mA}$	GHz		7.0	
hFE	Forward Current Transfer Ratio: $V_{CE} = 8\text{ V}, I_C = 35\text{ mA}$		30	150	300
ICBO	Collector Cutoff Current: $V_{CB} = 8\text{ V}$	μA			0.2
IEBO	Emitter Cutoff Current: $V_{EB} = 1\text{ V}$	μA			2.0
CCB	Collector Base Capacitance ¹ : $V_{CB} = 8\text{ V}, f = 1\text{ MHz}$	pF		0.8	

Note: 1. For this test, the emitter is grounded.

Absolute Maximum Ratings

Parameter	Symbol	Absolute Maximum ¹
Emitter-Base Voltage	V_{EBO}	1.5 V
Collector-Base Voltage	V_{CBO}	20 V
Collector-Emitter Voltage	V_{CEO}	12 V
Collector Current	I_C	150 mA
Power Dissipation ^{2,3}	P_T	1000 mW
Junction Temperature	T_J	200°C
Storage Temperature	T_{STG}	-65°C to 200°C

Thermal Resistance^{2,4}: $\theta_{JC} = 120^\circ\text{C}/\text{W}$

Notes:

1. Operation of this device above any one of these parameters may cause permanent damage.
2. $T_{CASE} = 25^\circ\text{C}$.
3. Derate at 8.3 mW/°C for $T_C > 80^\circ\text{C}$.
4. The small spot size of this technique results in a higher, though more accurate determination of θ_{JC} than do alternate methods. See MEASUREMENTS section "Thermal Resistance" for more information.

Typical Performance, $T_A = 25^\circ\text{C}$
(unless otherwise noted)

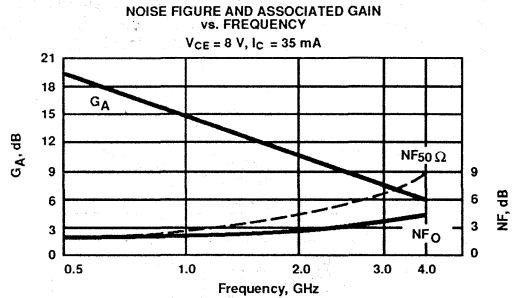
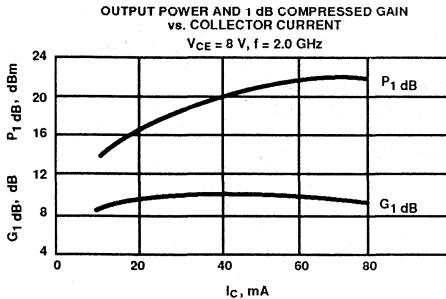
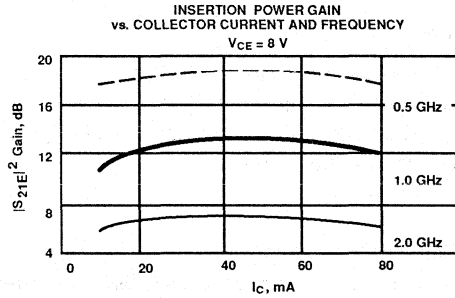

Typical Scattering Parameters: Common Emitter, $Z_0 = 50\ \Omega$

$T_A = 25^\circ\text{C}, V_{CE} = 8\text{ V}, I_C = 35\text{ mA}$

Freq. GHz	S_{11}		S_{21}			S_{12}			S_{22}	
	Mag	Ang	dB	Mag	Ang	dB	Mag	Ang	Mag	Ang
0.1	.68	-129	31.1	36.01	122	-35.4	.017	47	.56	-71
0.5	.77	-173	18.7	8.63	88	-30.4	.030	42	.25	-133
1.0	.76	175	12.9	4.41	75	-26.8	.046	55	.22	-148
1.5	.76	167	9.6	3.02	64	-24.2	.062	54	.22	-153
2.0	.76	160	7.2	2.30	54	-22.0	.079	55	.22	-154
2.5	.76	157	5.5	1.88	49	-20.2	.098	58	.23	-156
3.0	.77	152	4.0	1.59	40	-19.1	.111	55	.25	-157
3.5	.77	147	2.9	1.39	31	-17.9	.128	50	.27	-159
4.0	.75	141	1.9	1.24	22	-16.8	.144	49	.29	-160
4.5	.74	135	1.1	1.13	13	-15.6	.166	44	.31	-162
5.0	.73	126	0.4	1.04	4	-14.8	.182	39	.32	-165

$T_A = 25^\circ\text{C}, V_{CE} = 8\text{ V}, I_C = 60\text{ mA}$

0.1	.70	-143	31.6	38.01	116	-35.4	.017	40	.48	-81
0.5	.77	-177	18.7	8.56	87	-31.4	.027	49	.24	-141
1.0	.77	173	12.8	4.36	74	-27.2	.043	59	.22	-152
1.5	.77	166	9.5	2.98	64	-23.8	.064	58	.22	-155
2.0	.77	159	7.1	2.27	53	-21.8	.082	59	.22	-157
2.5	.76	156	5.4	1.85	48	-20.2	.097	61	.23	-158
3.0	.77	152	3.9	1.56	39	-19.2	.110	57	.25	-159
3.5	.77	146	2.7	1.37	31	-17.7	.131	54	.27	-160
4.0	.76	141	1.7	1.22	21	-16.6	.148	51	.29	-161
4.5	.75	134	0.9	1.11	13	-15.4	.169	45	.31	-162
5.0	.73	126	0.2	1.02	3	-14.6	.186	41	.31	-166

A model for this device is available in the DEVICE MODELS section.

Features

- 24.0 dBm typical $P_{1\text{ dB}}$ at 1.0 GHz
- 5.5 dB typical $G_{1\text{ dB}}$ at 1.0 GHz
- High Gain-Bandwidth Product: 5.5 GHz typical f_T
- Hermetic, Metal Package

Description

Avantek's AT-01672 is a high performance NPN silicon bipolar transistor housed in a hermetic high reliability metal package. This device is designed for use in medium power amplifier applications operating over VHF, UHF and microwave frequencies.

Excellent device uniformity, performance and reliability are produced by the use of ion-implantation, self-alignment techniques, and gold metallization in the fabrication of these devices.

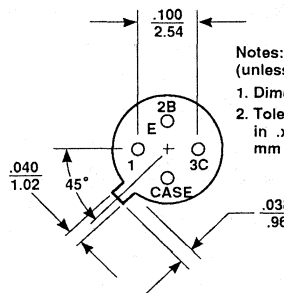
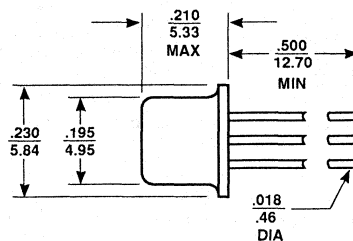
Avantek TO-72 Package

- Notes:
 (unless otherwise specified)
1. Dimensions are in mm
 2. Tolerances in .xxx = $\pm .005$ mm .xx = $\pm .13$

INSERTION POWER GAIN, MAXIMUM AVAILABLE GAIN AND MAXIMUM STABLE GAIN vs. FREQUENCY
 $V_{CE} = 8\text{ V}, I_C = 35\text{ mA}$

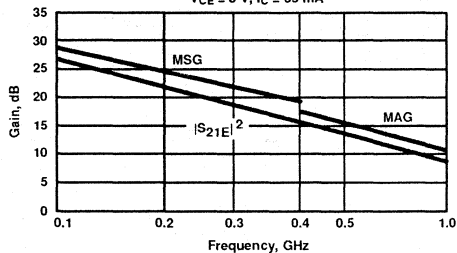
Electrical Specifications, $T_A = 25^\circ\text{C}$

Symbol	Parameters and Test Conditions	Units	Min.	Typ.	Max.
$ S_{21E} ^2$	Insertion Power Gain: $V_{CE} = 8\text{ V}, I_C = 35\text{ mA}$ $f = 0.5\text{ GHz}$ $f = 1.0\text{ GHz}$	dB	13.0	14.5 9.0	
$P_{1\text{ dB}}$	Power Output @ 1 dB Gain Compression: $V_{CE} = 8\text{ V}, I_C = 60\text{ mA}$ $f = 1.0\text{ GHz}$	dBm		24.0	
$G_{1\text{ dB}}$	1 dB Compressed Gain: $V_{CE} = 8\text{ V}, I_C = 60\text{ mA}$ $f = 1.0\text{ GHz}$	dB		5.5	
NFO	Optimum Noise Figure: $V_{CE} = 8\text{ V}, I_C = 35\text{ mA}$ $f = 0.5\text{ GHz}$ $f = 1.0\text{ GHz}$	dB		2.0 3.0	
G_A	Gain @ NFO: $V_{CE} = 8\text{ V}, I_C = 35\text{ mA}$ $f = 0.5\text{ GHz}$ $f = 1.0\text{ GHz}$	dB		10.5 6.5	
f_T	Gain Bandwidth Product: $V_{CE} = 8\text{ V}, I_C = 10\text{ mA}$	GHz		5.5	
hFE	Forward Current Transfer Ratio: $V_{CE} = 8\text{ V}, I_C = 35\text{ mA}$		30	150	300
ICBO	Collector Cutoff Current: $V_{CB} = 8\text{ V}$	μA			0.2
IEBO	Emitter Cutoff Current: $V_{EB} = 1\text{ V}$	μA			2.0
CCB	Collector Base Capacitance ¹ : $V_{CB} = 8\text{ V}, f = 1\text{ MHz}$	pF		1.0	

Note: 1. For this test, the emitter is grounded.

Absolute Maximum Ratings

Parameter	Symbol	Absolute Maximum ¹
Emitter-Base Voltage	VEBO	1.5 V
Collector-Base Voltage	VCBO	20 V
Collector-Emitter Voltage	VCEO	12 V
Collector Current	IC	150 mA
Power Dissipation ^{2,3}	PT	1000 mW
Junction Temperature	Tj	200°C
Storage Temperature	TSTG	-65° to 200°C

Thermal Resistance^{2,4}: $\theta_{jC} = 190^\circ\text{C/W}$

Notes:

1. Operation of this device above any one of these parameters may use permanent damage.
2. TCASE = 25°C.
3. Derate at 5.3 mW/°C for TC > 10°C.
4. The small spot size of this technique results in a higher, though more accurate determination of θ_{jC} than do alternate methods. See MEASUREMENTS section "Thermal Resistance" for more information.

Typical Performance, TA = 25°C

(unless otherwise noted)

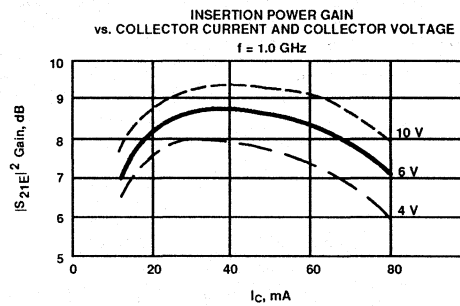
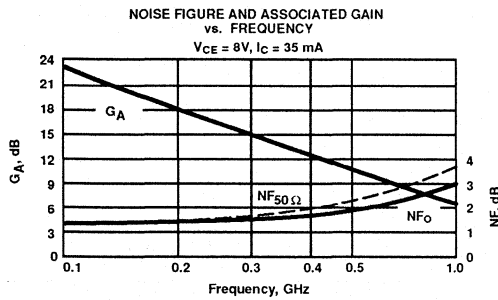
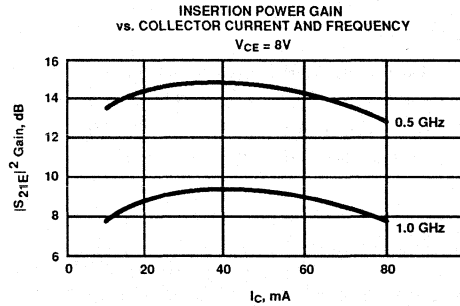

Typical Scattering Parameters: Common Emitter, ZO = 50 Ω

TA = 25°C, VCE = 8 V, IC = 35 mA

Freq. GHz	S11		dB	S21		dB	S12		dB	S22	
	Mag	Ang		Mag	Ang		Mag	Ang		Mag	Ang
0.1	.33	-81	26.7	21.73	114	-30.2	.031	72	.51	-36	
0.2	.22	-112	21.8	12.28	98	-26.0	.050	75	.36	-36	
0.3	.19	-134	18.7	8.61	92	-22.8	.072	74	.30	-37	
0.4	.18	-148	16.4	6.58	83	-21.0	.090	72	.26	-34	
0.5	.17	-159	14.6	5.35	79	-19.1	.111	70	.22	-33	
0.6	.17	-171	13.1	4.51	77	-17.5	.133	71	.21	-38	
0.7	.17	178	12.0	3.97	72	-16.2	.154	68	.19	-45	
0.8	.18	171	11.1	3.61	68	-15.3	.172	66	.18	-53	
0.9	.18	169	9.9	3.12	65	-14.3	.192	66	.20	-58	
1.0	.19	164	9.2	2.89	61	-13.5	.212	63	.22	-60	

TA = 25°C, VCE = 8 V, IC = 60 mA

0.1	.30	-92	26.7	21.60	110	-30.4	.030	73	.47	-35
0.2	.22	-125	21.5	11.92	96	-26.2	.049	76	.33	-35
0.3	.21	-145	18.4	8.29	90	-23.0	.070	75	.28	-34
0.4	.20	-159	16.1	6.35	82	-21.0	.089	72	.26	-31
0.5	.19	-169	14.2	5.16	77	-19.3	.109	70	.23	-31
0.6	.20	-178	12.8	4.34	76	-17.7	.131	72	.21	-37
0.7	.20	173	11.6	3.81	71	-16.4	.152	68	.19	-43
0.8	.21	167	10.8	3.47	67	-15.4	.170	66	.19	-51
0.9	.21	165	9.5	2.99	64	-14.5	.189	67	.21	-58
1.0	.22	160	8.9	2.78	60	-13.6	.208	64	.23	-60

A model for this device is available in the DEVICE MODELS section.

Features

- **Fundamental Oscillation to > 20 GHz**
- **Low Phase Noise Compared to GaAs FETs**
- **High S21 Gain: 9.5 dB Typical at 4 GHz**
- **High MAG: 16.5 dB Typical at 4 GHz**

Description

Avantek's AT-21400 is a very high performance NPN silicon bipolar transistor chip designed for use in low-phase noise narrow and wideband oscillator applications at fundamental frequencies to greater than 20 GHz.

The AT-21400 oscillator transistor is fabricated using Avantek's 10 GHz f_T , 40 GHz f_{MAX} TurboSAT silicon bipolar process which uses nitride self-alignment, thick planar-field oxide, subhalfmicrometer lithography, ion implantation, gold metallization and nitride scratch protection to achieve excellent performance, uniformity and reliability.

The recommended mounting procedure is gold-silicon eutectic die attach at 400°C. Assembly can be performed with either wedge or ball bonding using 0.5 or 0.7 mil gold wire. See also "Chip Use" in the APPLICATIONS section.

Avantek Chip Outline¹

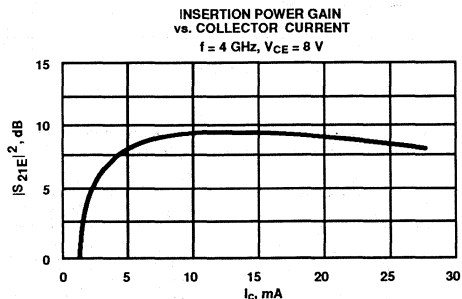
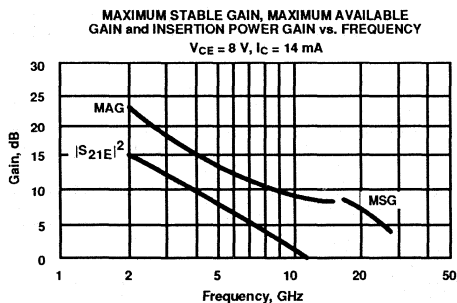
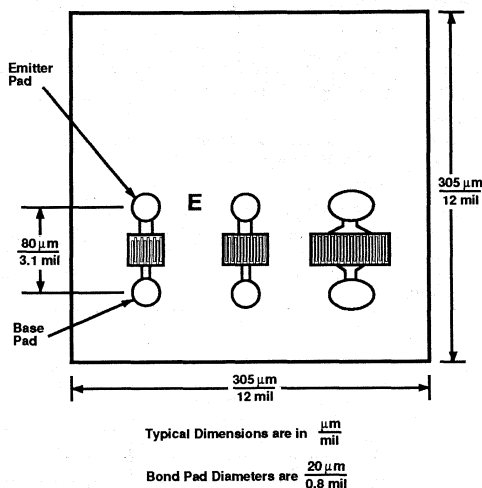

Electrical Specifications, $T_A = 25^\circ\text{C}$

Symbol	Parameters and Test Conditions ^{1,2,3}	Units	Min.	Typ.	Max.
MAG	Maximum Available Gain: $V_{CE} = 8 \text{ V}, I_C = 14 \text{ mA}$ $f = 4 \text{ GHz}$	dB		16.5	
$ S_{21E} ^2$	Insertion Power Gain: $V_{CE} = 8 \text{ V}, I_C = 14 \text{ mA}$ $f = 4 \text{ GHz}$	dB		9.5	
f_T	Gain Bandwidth Product: $V_{CE} = 8 \text{ V}, I_C = 14 \text{ mA}$ $f = 2 \text{ GHz}$	GHz		10	
hFE	Forward Current Transfer Ratio: $V_{CE} = 8 \text{ V}, I_C = 14 \text{ mA}$		30	100	300
ICBO	Collector Cutoff Current: $V_{CB} = 8 \text{ V}$	μA			0.2
IEBO	Emitter Cutoff Current: $V_{EB} = 1 \text{ V}$	μA			5.0
CCB	Collector Base Capacitance: $V_{CB} = 8 \text{ V}$ $f = 1 \text{ MHz}$	pF		.08	

Notes: 1. This chip contains 3 active transistors. The performance specified applies only to the device whose base and emitter pads are indicated on the chip outline. Performance and functionality of the other 2 transistors is not guaranteed.
 2. RF performance of the chip is determined by testing 10 devices per wafer assembled in a common-emitter configuration on a standard chip carrier.
 3. The normal operating collector current range for this transistor is 10 to 15 mA.

Absolute Maximum Ratings

Parameter	Symbol	Absolute Maximum ¹
Emitter-Base Voltage	VEBO	1.5 V
Collector-Base Voltage	VCBO	20 V
Collector-Emitter Voltage	VCEO	10 V
Collector Current	IC	28 mA
Power Dissipation ²	PT	250 mW
Junction Temperature	Tj	200°C
Storage Temperature	TSTG	-65°C to 200°C

Thermal Resistance; junction to substrate³: $\theta_{js} = 170^\circ\text{C/W}$

Notes:

1. Permanent damage may occur if any of these limits are exceeded.
2. Derate at 5.9 m W/°C for T_{MOUNTING SURFACE} > 158°C.
3. T_{MOUNTING SURFACE} = 25°C.

Part Number Ordering Information

Part Number	Devices Per Tray
AT-21400-GP1	5
AT-21400-GP4	100
AT-21400-GP6	up to 300

LINEAR EQUIVALENT CIRCUIT⁴

V_{CE} = 8 V, I_C = 14 mA

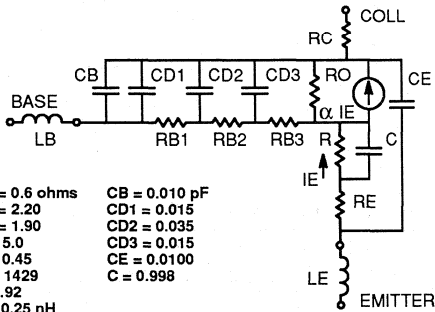

RB1 = 0.6 ohms CB = 0.010 pF
 RB2 = 2.20 CD1 = 0.015
 RB3 = 1.90 CD2 = 0.035
 RC = 5.0 CD3 = 0.015
 RE = 0.45 CE = 0.0100
 RO = 1429 C = 0.998
 R = 1.92
 LB = 0.25 nH
 LE = 0.10

TOUCHSTONE™ CCCS: M=,99, A=0
 R1=R, R2=1E8, F=22.7, T=7.4

SPICE EQUIVALENT CIRCUIT⁴

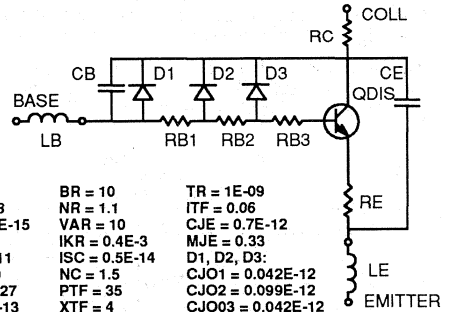

QDIS: BR = 10 TR = 1E-09
 XTB = 1.8 NR = 1.1 ITF = 0.06
 IS = 0.65E-15 VAR = 10 CJE = 0.7E-12
 BF = 100 IKR = 0.4E-3 MJE = 0.33
 NF = 1.011 ISC = 0.5E-14 D1, D2, D3:
 VAF = 20 NC = 1.5 CJO1 = 0.042E-12
 IKF = 0.027 PTF = 35 CJO2 = 0.099E-12
 ISE = 3E-13 XTF = 4 CJO3 = 0.042E-12
 NE = 2.0 TF = 12E-12 IS = 0, VJ = 0.73

Modeled Scattering Parameters, Common Emitter⁵

T_A = 25°C, V_{CE} = 8 V, I_C = 14 mA

Freq. GHz	S ₁₁		S ₂₁			S ₁₂			S ₂₂	
	Mag	Ang	dB	Mag	Ang	dB	Mag	Ang	Mag	Ang
2	.67	-168	15.8	6.19	90	-34.0	.02	52	.65	-9
3	.67	-180	12.4	4.17	81	-32.0	.025	59	.65	-10
4	.67	172	10.0	3.15	74	-30.5	.03	64	.65	-11
5	.68	165	8.1	2.53	68	-28.0	.04	68	.65	-12
6	.68	160	6.5	2.12	62	-28.0	.04	70	.65	-14
7	.69	154	5.2	1.82	56	-26.0	.05	72	.65	-16
8	.70	149	4.1	1.60	51	-24.4	.06	73	.65	-18
9	.70	144	3.1	1.43	46	-24.4	.06	74	.65	-20
10	.71	140	2.2	1.29	41	-23.1	.07	74	.65	-22
11	.72	135	1.4	1.18	36	-21.9	.08	74	.65	-24
12	.73	131	0.7	1.08	31	-21.9	.08	75	.66	-26
13	.74	127	0	1.00	27	-20.9	.09	75	.66	-28
14	.75	123	-0.6	0.93	23	-20.0	.10	75	.66	-30
15	.76	120	-1.3	0.86	18	-19.2	.11	74	.67	-32
16	.77	116	-1.9	0.80	14	-19.2	.11	74	.67	-34
18	.79	109	-3.1	0.70	7	-17.7	.13	74	.68	-39
20	.80	103	-4.2	0.62	-1	-17.1	.14	73	.69	-44
22	.82	97	-5.4	0.54	-7	-15.9	.16	72	.70	-48
24	.84	92	-6.6	0.47	-14	-14.9	.18	71	.71	-53
26	.85	87	-8.0	0.40	-20	-14.0	.20	70	.72	-58

Notes: 4. These equivalent circuits are provided only as 1st-order design aids. Their accuracy for critical designs at very high frequencies has not been validated.
 5. S-Parameters are from linear equivalent circuit. Below 10 GHz, they have been fit to measurements of die on a standard carrier with 1 bond wire to the base and 4 bond wires to the emitter.

Features

- **Low Noise Figure: 1.6 dB typical at 2.0 GHz**
3.0 dB typical at 4.0 GHz
- **High Associated Gain: 14.5 dB typical at 2.0 GHz**
10.5 dB typical at 4.0 GHz
- **High Gain-Bandwidth Product: 9.0 GHz typical f_T**

Description

Avantek's AT-41400 is a high performance NPN silicon bipolar transistor chip designed for use low noise, wide band amplifier and oscillator applications operating over VHF, UHF and microwave frequencies.

The die are nitride-passivated for surface protection. Excellent device uniformity, performance and reliability are produced by the use of ion-implantation, self-alignment techniques, and gold metallization in the fabrication of these devices.

The recommended assembly procedure is gold-eutectic die attach at 400°C and either wedge or ball bonding using 0.7 mil gold wire. See also "Chip Use" in the APPLICATIONS section.

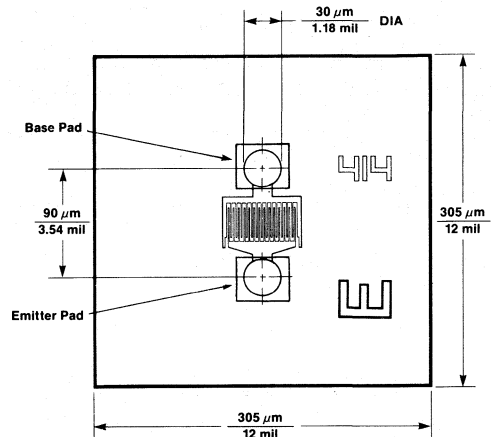
Avantek Chip Outline

NOISE FIGURE AND ASSOCIATED GAIN vs. FREQUENCY
 $V_{CE} = 8 V, I_C = 10 mA$

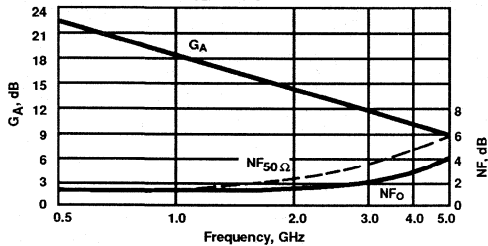

Noise Parameters: $V_{CE} = 8 V, I_C = 10 mA$

Freq. GHz	NF ₀ dB	Gamma Mag	Opt Ang	R _N /50
0.1	1.2	.12	3	0.17
0.5	1.2	.10	15	0.17
1.0	1.3	.06	27	0.16
2.0	1.6	.24	163	0.16
4.0	3.0	.52	-153	0.18

Electrical Specifications, $T_A = 25^\circ C$

Symbol	Parameters and Test Conditions ¹	Units	Min.	Typ.	Max.
NF ₀	Optimum Noise Figure: $V_{CE} = 8 V, I_C = 10 mA$				
		f = 1.0 GHz		1.3	
		f = 2.0 GHz		1.6	
		f = 4.0 GHz		3.0	
GA	Gain @ NF ₀ : $V_{CE} = 8 V, I_C = 10 mA$				
		f = 1.0 GHz		18.5	
		f = 2.0 GHz		14.5	
		f = 4.0 GHz		10.5	
$ S_{21E} ^2$	Insertion Power Gain: $V_{CE} = 8 V, I_C = 25 mA$				
		f = 2.0 GHz		12.0	
		f = 4.0 GHz		6.5	
P ₁ dB	Power Output @ 1 dB Gain Compression: $V_{CE} = 8 V, I_C = 25 mA$				
		f = 2.0 GHz		19.0	
		f = 4.0 GHz		18.5	
G ₁ dB	1 dB Compressed Gain: $V_{CE} = 8 V, I_C = 25 mA$				
		f = 2.0 GHz		15.0	
		f = 4.0 GHz		10.5	
f_T	Gain Bandwidth Product: $V_{CE} = 8 V, I_C = 25 mA$				
				9.0	
h _{FE}	Forward Current Transfer Ratio: $V_{CE} = 8 V, I_C = 10 mA$				
			30	150	300
I _{CB0}	Collector Cutoff Current: $V_{CB} = 8 V$				
					0.2
I _{EBO}	Emitter Cutoff Current: $V_{EB} = 1 V$				
					1.0
CCB	Collector Base Capacitance ² : $V_{CB} = 8 V, f = 1 MHz$				
				0.17	

Notes: 1. RF performance is determined by packaging and testing 10 devices per wafer.
 2. For this test, the emitter is grounded.

Absolute Maximum Ratings

Parameter	Symbol	Absolute Maximum
Emitter-Base Voltage	VEBO	1.5 V
Collector-Base Voltage	VCBO	20 V
Collector-Emitter Voltage	VCEO	12 V
Collector Current	IC	60 mA
Power Dissipation ^{2,3}	PT	500 mW
Junction Temperature	Tj	200°C
Storage Temperature	TSTG	-65°C to 200°C

Thermal Resistance^{2,4}: $\theta_{jC} = 95^\circ\text{C/W}$

Notes:

1. Operation of this device above any one of these parameters may cause permanent damage.
2. TMOUNTING SURFACE = 25°C.
3. Derate at 10.5 mW/°C for TMOUNTING SURFACE > 153°C.
4. The small spot size of this technique results in a higher, though more accurate determination of θ_{jC} than do alternate methods. See MEASUREMENTS section "Thermal Resistance" for more information.

Part Number Ordering Information

Part Number	Devices Per Tray
AT-41400-GP2	10
AT-41400-GP4	100
AT-41400-GP6	up to 300

Typical Performance, TA = 25°C

(unless otherwise noted)

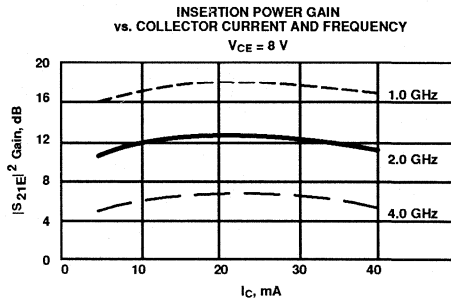
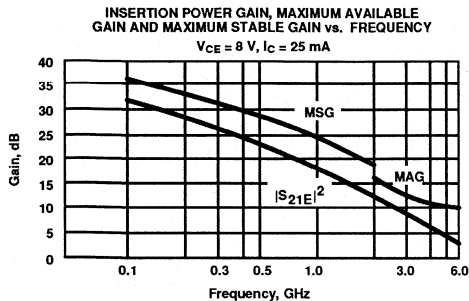
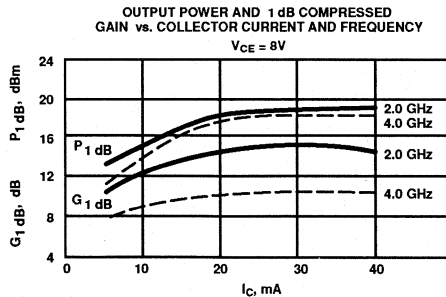
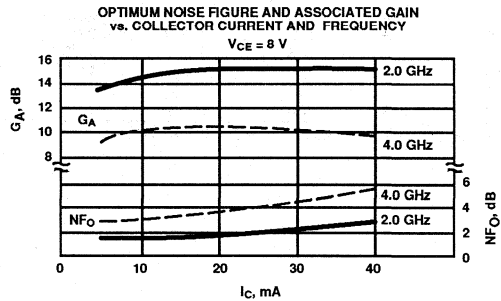
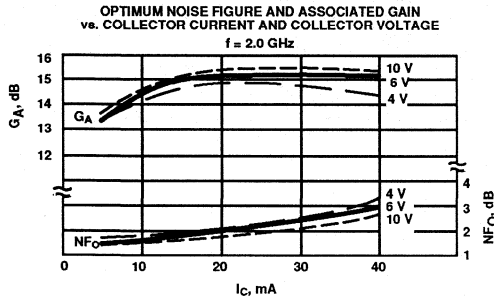

AT-41400
Low Noise Silicon Bipolar Transistor

Typical Scattering Parameters: Common Emitter, $Z_O = 50 \Omega$

$T_A = 25^\circ\text{C}$, $V_{CE} = 8 \text{ V}$, $I_C = 10 \text{ mA}$

Freq. GHz	S ₁₁		S ₂₁			S ₁₂			S ₂₂	
	Mag	Ang	dB	Mag	Ang	dB	Mag	Ang	Mag	Ang
0.1	.73	-39	28.3	25.84	159	-39.2	.011	75	.94	-12
0.5	.60	-121	22.2	12.91	113	-30.2	.031	48	.61	-28
1.0	.57	-156	17.2	7.27	94	-28.0	.040	51	.50	-25
1.5	.56	-172	13.7	4.84	84	-26.4	.048	59	.47	-25
2.0	.57	176	11.4	3.71	77	-24.9	.057	66	.46	-24
2.5	.57	170	9.5	2.97	71	-23.6	.066	69	.46	-26
3.0	.60	164	8.0	2.52	64	-22.3	.077	72	.45	-28
3.5	.60	157	6.8	2.18	61	-20.9	.090	77	.47	-29
4.0	.61	152	5.5	1.89	55	-20.1	.099	79	.47	-30
4.5	.63	147	4.7	1.72	51	-18.7	.116	81	.47	-36
5.0	.63	144	3.7	1.53	46	-17.8	.129	80	.48	-40
5.5	.65	139	3.1	1.42	42	-17.0	.141	82	.49	-44
6.0	.66	136	2.1	1.28	38	-16.1	.156	83	.50	-47

$T_A = 25^\circ\text{C}$, $V_{CE} = 8 \text{ V}$, $I_C = 25 \text{ mA}$

0.1	.56	-60	31.8	39.07	152	-40.9	.009	69	.87	-18
0.5	.54	-145	23.5	15.00	104	-32.8	.023	56	.49	-28
1.0	.54	-170	18.1	8.03	90	-29.6	.033	65	.42	-23
1.5	.55	179	14.5	5.30	82	-26.9	.045	72	.41	-22
2.0	.56	170	12.1	4.04	76	-24.7	.058	75	.41	-23
2.5	.56	165	10.2	3.24	72	-23.1	.070	78	.40	-23
3.0	.58	159	8.8	2.75	65	-21.6	.083	79	.40	-25
3.5	.59	154	7.5	2.37	62	-20.4	.096	82	.41	-26
4.0	.60	149	6.3	2.06	57	-19.3	.108	83	.42	-28
4.5	.61	145	5.4	1.87	53	-18.1	.124	84	.42	-33
5.0	.62	142	4.5	1.67	49	-17.3	.136	83	.43	-36
5.5	.64	137	3.8	1.54	44	-16.5	.150	85	.42	-40
6.0	.65	134	2.9	1.40	41	-15.7	.165	84	.44	-45

A model for this device is available in the DEVICE MODELS section.

Features

- **Low Noise Figure:** 1.6 dB typical at 2.0 GHz
3.0 dB typical at 4.0 GHz
- **High Associated Gain:** 14.0 dB typical at 2.0 GHz
10.0 dB typical at 4.0 GHz
- **High Gain-Bandwidth Product:** 8.0 GHz typical f_T
- **Hermetic, Gold-ceramic Microstrip Package**

Description

Avantek's AT-41410 is a high performance NPN silicon bipolar transistor housed in a hermetic, high reliability package. This device is designed for use in low noise, wide band amplifier and oscillator applications operating over VHF, UHF and microwave frequencies.

Excellent device uniformity, performance and reliability are produced by the use of ion-implantation, self-alignment techniques, and gold metallization in the fabrication of these devices.

Avantek 100 mil Package

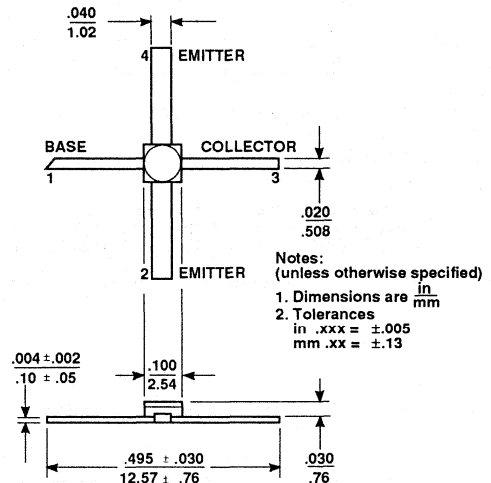

NOISE FIGURE AND ASSOCIATED GAIN
vs. FREQUENCY
 $V_{CE} = 8\text{ V}, I_C = 10\text{ mA}$

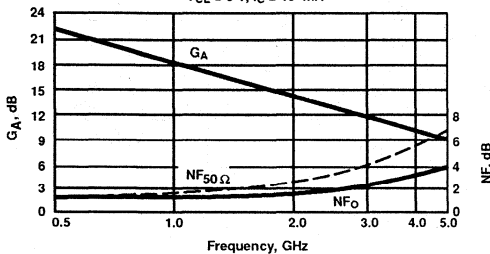

Noise Parameters: $V_{CE} = 8\text{ V}, I_C = 10\text{ mA}$

Freq. GHz	NF ₀ dB	Gamma Opt Mag	Ang	R _N /50
0.1	1.2	.12	4	0.17
0.5	1.2	.10	23	0.17
1.0	1.3	.06	49	0.16
2.0	1.6	.26	172	0.16
4.0	3.0	.46	-133	0.26

Electrical Specifications, $T_A = 25^\circ\text{C}$

Symbol	Parameters and Test Conditions	Units	Min.	Typ.	Max.
NF ₀	Optimum Noise Figure: $V_{CE} = 8\text{ V}, I_C = 10\text{ mA}$	f = 1.0 GHz f = 2.0 GHz f = 4.0 GHz		1.3 1.6 3.0	1.9
GA	Gain @ NF ₀ : $V_{CE} = 8\text{ V}, I_C = 10\text{ mA}$	f = 1.0 GHz f = 2.0 GHz f = 4.0 GHz	13.0	18.5 14.0 10.0	
$ S_{21E} ^2$	Insertion Power Gain: $V_{CE} = 8\text{ V}, I_C = 25\text{ mA}$	f = 2.0 GHz f = 4.0 GHz		12.0 6.5	
P ₁ dB	Power Output @ 1 dB Gain Compression: $V_{CE} = 8\text{ V}, I_C = 25\text{ mA}$	f = 2.0 GHz f = 4.0 GHz		19.0 18.5	
G ₁ dB	1 dB Compressed Gain: $V_{CE} = 8\text{ V}, I_C = 25\text{ mA}$	f = 2.0 GHz f = 4.0 GHz		14.0 9.5	
f_T	Gain Bandwidth Product: $V_{CE} = 8\text{ V}, I_C = 25\text{ mA}$			8.0	
hFE	Forward Current Transfer Ratio: $V_{CE} = 8\text{ V}, I_C = 10\text{ mA}$		30	150	300
ICBO	Collector Cutoff Current: $V_{CB} = 8\text{ V}$				0.2
IEBO	Emitter Cutoff Current: $V_{EB} = 1\text{ V}$				1.0
CCB	Collector Base Capacitance ¹ : $V_{CB} = 8\text{ V}, f = 1\text{ MHz}$			0.2	

Note: 1. For this test, the emitter is grounded.

AT-41410

Low Noise Silicon Bipolar Transistor

Absolute Maximum Ratings

Parameter	Symbol	Absolute Maximum ¹
Emitter-Base Voltage	V_{EBO}	1.5 V
Collector-Base Voltage	V_{CBO}	20 V
Collector-Emitter Voltage	V_{CEO}	12 V
Collector Current	I_C	60 mA
Power Dissipation ^{2,3}	P_T	500 mW
Junction Temperature	T_j	200°C
Storage Temperature	T_{STG}	-65° to 200°C

Thermal Resistance^{2,4}: $\theta_{jC} = 170^\circ\text{C/W}$

Notes:

- Operation of this device above any one of these parameters may cause permanent damage.
- $TCASE = 25^\circ\text{C}$.
- Derate at $5.9 \text{ mW}/^\circ\text{C}$ for $T_C > 115^\circ\text{C}$.
- The small spot size of this technique results in a higher, though more accurate determination of θ_{jC} than do alternate methods. See MEASUREMENTS section "Thermal Resistance" for more information.

Typical Performance, $T_A = 25^\circ\text{C}$

(unless otherwise noted)

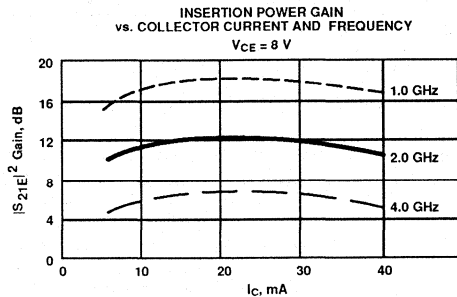
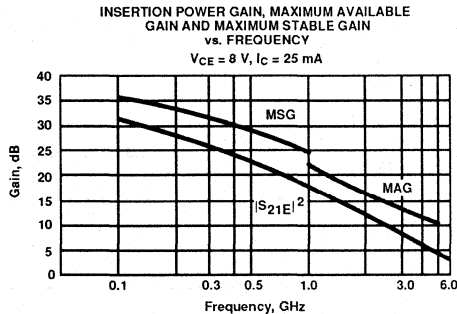
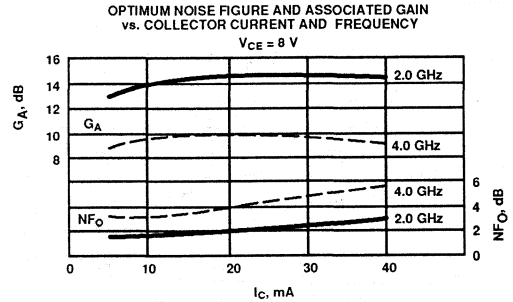
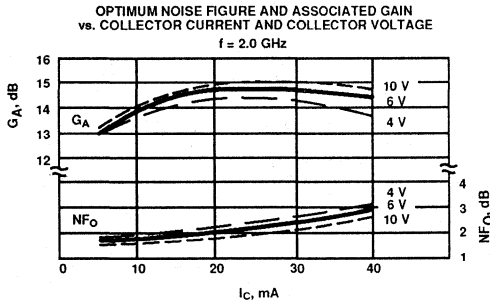
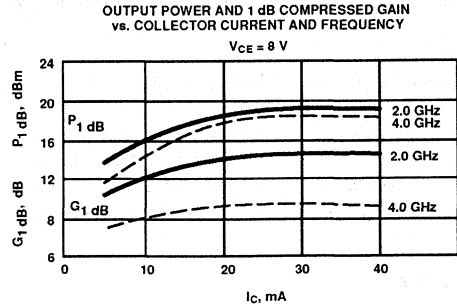

AT-41410
Low Noise Silicon Bipolar Transistor

Typical Scattering Parameters: Common Emitter, $Z_O = 50 \Omega$

$T_A = 25^\circ\text{C}$, $V_{CE} = 8 \text{ V}$, $I_C = 10 \text{ mA}$

Freq. GHz	S_{11}		S_{21}			S_{12}			S_{22}	
	Mag	Ang	dB	Mag	Ang	dB	Mag	Ang	Mag	Ang
0.1	.61	-40	27.7	24.38	159	-40.0	.010	75	.94	-13
0.5	.60	-127	22.2	12.83	110	-30.4	.030	40	.62	-33
1.0	.60	-163	17.1	7.12	86	-28.2	.039	35	.50	-38
1.5	.60	179	13.8	4.89	71	-27.5	.042	45	.46	-42
2.0	.61	165	11.4	3.72	59	-26.0	.050	42	.45	-48
2.5	.61	157	9.7	3.04	52	-24.7	.058	46	.44	-52
3.0	.62	149	8.2	2.56	42	-23.9	.064	50	.44	-58
3.5	.63	140	7.0	2.23	31	-22.3	.077	48	.46	-68
4.0	.62	130	5.9	1.96	20	-21.3	.086	44	.48	-78
4.5	.61	120	4.9	1.76	10	-20.4	.095	41	.50	-85
5.0	.61	106	4.0	1.59	-1	-18.9	.113	38	.52	-91
5.5	.62	94	3.2	1.45	-11	-18.3	.121	33	.52	-97
6.0	.66	82	2.4	1.31	-22	-17.5	.133	30	.51	-105

$T_A = 25^\circ\text{C}$, $V_{CE} = 8 \text{ V}$, $I_C = 25 \text{ mA}$

0.1	.45	-69	31.4	37.17	150	-39.2	.011	64	.87	-18
0.5	.58	-153	23.3	14.63	101	-33.6	.021	43	.49	-33
1.0	.59	-178	17.7	7.68	81	-30.4	.030	53	.43	-35
1.5	.60	169	14.3	5.21	68	-28.2	.039	58	.41	-40
2.0	.60	157	11.9	3.94	56	-25.8	.051	55	.41	-45
2.5	.61	151	10.1	3.20	50	-24.4	.060	55	.40	-49
3.0	.62	144	8.6	2.70	40	-23.1	.070	58	.40	-56
3.5	.63	135	7.4	2.35	30	-21.9	.080	54	.42	-66
4.0	.62	126	6.3	2.07	19	-20.5	.094	53	.44	-76
4.5	.61	116	5.3	1.85	9	-19.3	.108	45	.46	-84
5.0	.61	103	4.5	1.67	-2	-18.5	.119	41	.49	-90
5.5	.63	91	3.6	1.52	-12	-17.6	.131	34	.49	-96
6.0	.67	80	2.8	1.37	-22	-16.8	.144	29	.47	-104

A model for this device is available in the DEVICE MODELS section.

Features

- **Low Noise Figure: 1.4 dB typical at 1.0 GHz**
1.8 dB typical at 2.0 GHz
- **High Associated Gain: 18.0 dB typical at 1.0 GHz**
13.0 dB typical at 2.0 GHz
- **High Gain-Bandwidth Product: 7.0 GHz typical f_T**
- **Low Cost Surface Mount Plastic Package**
- **Tape-and-Reel Packaging Option Available¹**

Description

Avantek's AT-41411 is a low cost NPN silicon bipolar transistor housed in the surface mount plastic SOT-143 package. This device is designed for use in low noise, wide band amplifier and oscillator applications operating over VHF, UHF and microwave frequencies.

Excellent device uniformity, performance and reliability are produced by the use of ion-implantation, self-alignment techniques, and gold metallization in the fabrication of these devices.

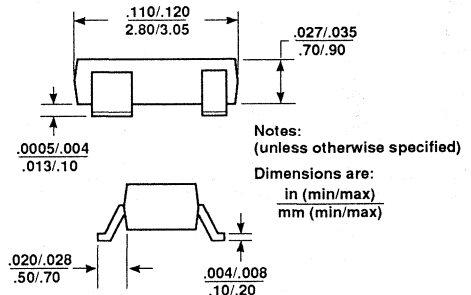
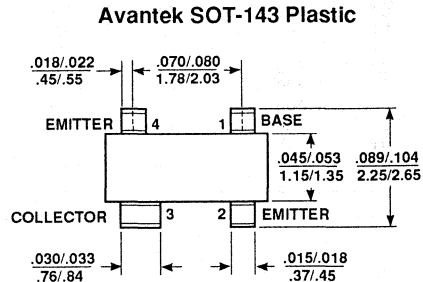
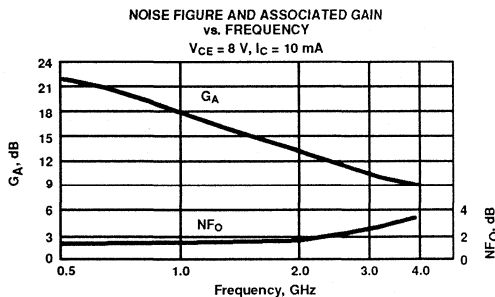
Noise Parameters: $V_{CE} = 8 \text{ V}, I_C = 10 \text{ mA}$

Freq. GHz	NF ₀ dB	Gamma Opt Mag	Ang	R _N /50
0.1	1.3	.12	4	0.17
0.5	1.3	.10	23	0.17
1.0	1.4	.07	57	0.16
2.0	1.8	.09	-158	0.16
4.0	3.5	.31	-87	0.38

Electrical Specifications, $T_A = 25^\circ\text{C}$

Symbol	Parameters and Test Conditions	Units	Min.	Typ.	Max.
NF ₀	Optimum Noise Figure: $V_{CE} = 8 \text{ V}, I_C = 10 \text{ mA}$	dB		1.4 1.8 3.5	
GA	Gain @ NF ₀ : $V_{CE} = 8 \text{ V}, I_C = 10 \text{ mA}$	dB		18.0 13.0 9.0	
$ S_{21E} ^2$	Insertion Power Gain: $V_{CE} = 8 \text{ V}, I_C = 20 \text{ mA}$	dB	14.5	16.5 11.0	
P ₁ dB	Power Output @ 1 dB Gain Compression: $V_{CE} = 8 \text{ V}, I_C = 20 \text{ mA}$	dBm		17.0	
G ₁ dB	1 dB Compressed Gain: $V_{CE} = 8 \text{ V}, I_C = 20 \text{ mA}$	dB		13.0	
f_T	Gain Bandwidth Product: $V_{CE} = 8 \text{ V}, I_C = 20 \text{ mA}$	GHz		7.0	
hFE	Forward Current Transfer Ratio: $V_{CE} = 8 \text{ V}, I_C = 10 \text{ mA}$		30	150	300
I _{CBO}	Collector Cutoff Current: $V_{CB} = 8 \text{ V}$	mA			0.2
I _{EBO}	Emitter Cutoff Current: $V_{EB} = 1 \text{ V}$	mA			1.0

Note: 1. Refer to PACKAGING section "Tape-and-Reel Packaging for Surface Mount Semiconductors".

Absolute Maximum Ratings

Parameter	Symbol	Absolute Maximum ¹
Emitter-Base Voltage	VEBO	1.5 V
Collector-Base Voltage	VCBO	20 V
Collector-Emitter Voltage	VCEO	12 V
Collector Current	IC	50 mA
Power Dissipation ^{2,3}	PT	225 mW
Junction Temperature	Tj	150°C
Storage Temperature	TSTG	-65°C to 150°C

Thermal Resistance^{2,4}: $\theta_{jc} = 550^\circ \text{C/W}$

Notes:

1. Operation of this device above any one of these parameters may cause permanent damage.
2. TCASE = 25°C.
3. Derate at 1.8 mW/°C for TC > 26°C.
4. See MEASUREMENTS section "Thermal Resistance" for more information

Part Number Ordering Information

Part Number	Devices Per Reel	Reel Size
AT-41411-TR1	3000	7"
AT-41411-TR2	10000	13"

Typical Performance, TA = 25°C

(unless otherwise noted)

OPTIMUM NOISE FIGURE AND ASSOCIATED GAIN vs. COLLECTOR CURRENT AND FREQUENCY
VCE = 8 V, f = 2.0 GHz

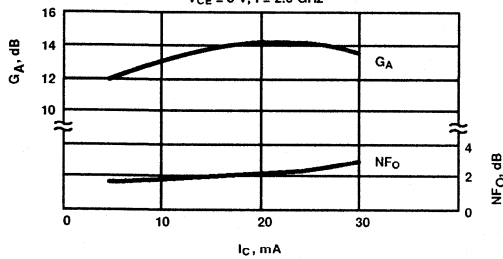

INSERTION POWER GAIN vs. COLLECTOR CURRENT AND FREQUENCY
VCE = 8 V

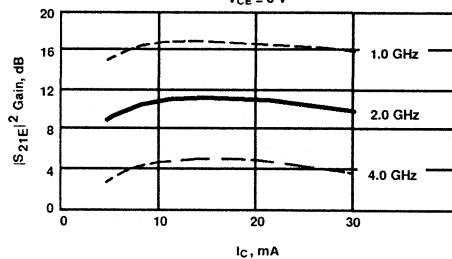

INSERTION POWER GAIN, MAXIMUM AVAILABLE GAIN AND MAXIMUM STABLE GAIN vs. FREQUENCY
VCE = 8 V, IC = 20 mA

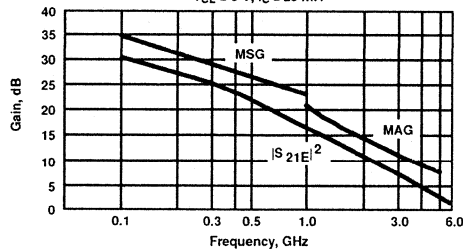

AT-41411
Low Noise Silicon Bipolar Transistor

Typical Scattering Parameters: Common Emitter, $Z_0 = 50 \Omega$

$T_A = 25^\circ\text{C}$, $V_{CE} = 8 \text{ V}$, $I_C = 10 \text{ mA}$

Freq. GHz	S_{11}		S_{21}			S_{12}			S_{22}	
	Mag	Ang	dB	Mag	Ang	dB	Mag	Ang	Mag	Ang
0.1	.85	-30	27.3	23.20	158	-37.7	.013	64	.93	-11
0.5	.58	-112	21.7	12.18	109	-29.1	.035	44	.62	-30
1.0	.49	-156	16.5	6.70	85	-27.2	.044	43	.50	-33
1.5	.49	178	13.2	4.58	71	-25.0	.056	47	.46	-36
2.0	.50	160	10.8	3.45	59	-23.4	.068	47	.45	-41
2.5	.53	153	9.0	2.82	53	-22.5	.075	56	.43	-43
3.0	.55	142	7.5	2.37	43	-21.0	.089	54	.43	-53
3.5	.56	133	6.1	2.02	33	-19.8	.102	52	.44	-63
4.0	.56	121	4.9	1.76	23	-18.8	.115	49	.46	-73

$T_A = 25^\circ\text{C}$, $V_{CE} = 8 \text{ V}$, $I_C = 20 \text{ mA}$

0.1	.65	-46	30.4	33.07	150	-40.0	.010	59	.89	-15
0.5	.46	-137	22.4	13.21	100	-32.0	.025	56	.57	-26
1.0	.43	-175	16.7	6.85	80	-28.4	.038	58	.52	-29
1.5	.44	163	13.3	4.63	67	-26.4	.048	61	.51	-32
2.0	.47	148	10.8	3.47	56	-24.2	.062	61	.50	-37
2.5	.50	140	9.0	2.82	50	-22.9	.071	60	.47	-39
3.0	.53	132	7.5	2.36	40	-20.7	.092	61	.46	-48
3.5	.55	122	6.1	2.02	30	-19.6	.105	57	.45	-60
4.0	.56	112	4.8	1.74	19	-18.3	.122	53	.45	-73

A model for this device is available in the DEVICE MODELS section.

Features

- **Low Noise Figure:** 1.7 dB typical at 2.0 GHz
 3.0 dB typical at 4.0 GHz
- **High Associated Gain:** 14.0 dB typical at 2.0 GHz
 10.0 dB typical at 4.0 GHz
- **High Gain-Bandwidth Product:** 8.0 GHz typical ft
- **Cost Effective Ceramic Microstrip Package**

Description

Avantek's AT-41435 is a high performance NPN silicon bipolar transistor housed in a cost effective, microstrip package. This device is designed for use in low noise, wide band amplifier and oscillator applications operating over VHF, UHF and microwave frequencies.

Excellent device uniformity, performance and reliability are produced by the use of ion-implantation, self-alignment techniques, and gold metallization in the fabrication of these devices.

Avantek 35 micro-X Package

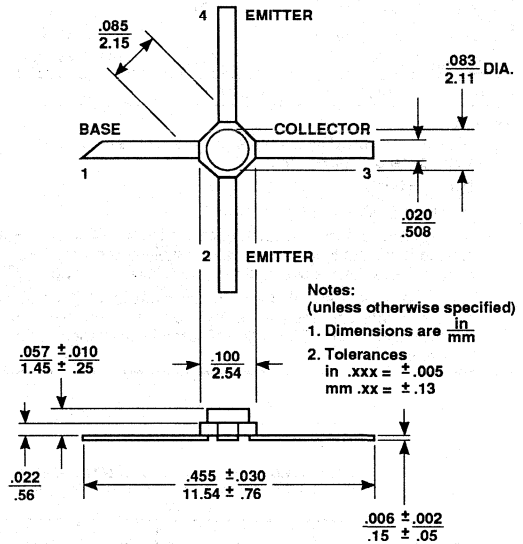

NOISE FIGURE AND ASSOCIATED GAIN vs. FREQUENCY
 $V_{CE} = 8\text{ V}, I_C = 10\text{ mA}$

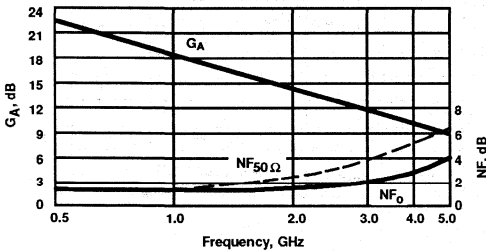

Noise Parameters: $V_{CE} = 8\text{ V}, I_C = 10\text{ mA}$

Freq. GHz	NF ₀ dB	Gamma Mag	Opt Ang	R _N /50
0.1	1.2	.12	3	0.17
0.5	1.2	.10	14	0.17
1.0	1.3	.05	28	0.17
2.0	1.7	.30	-154	0.16
4.0	3.0	.54	-118	0.35

Electrical Specifications, $T_A = 25^\circ\text{C}$

Symbol	Parameters and Test Conditions	Units	Min.	Typ.	Max.
NF ₀	Optimum Noise Figure: $V_{CE} = 8\text{ V}, I_C = 10\text{ mA}$	f = 1.0 GHz f = 2.0 GHz f = 4.0 GHz		1.3 1.7 3.0	2.0
G _A	Gain @ NF ₀ : $V_{CE} = 8\text{ V}, I_C = 10\text{ mA}$	f = 1.0 GHz f = 2.0 GHz f = 4.0 GHz	13.0	18.5 14.0 10.0	
S _{21E} ²	Insertion Power Gain: $V_{CE} = 8\text{ V}, I_C = 25\text{ mA}$	f = 2.0 GHz f = 4.0 GHz		11.5 6.0	
P ₁ dB	Power Output @ 1 dB Gain Compression: $V_{CE} = 8\text{ V}, I_C = 25\text{ mA}$	f = 2.0 GHz f = 4.0 GHz		19.0 18.5	
G ₁ dB	1 dB Compressed Gain: $V_{CE} = 8\text{ V}, I_C = 25\text{ mA}$	f = 2.0 GHz f = 4.0 GHz		14.0 9.5	
f _T	Gain Bandwidth Product: $V_{CE} = 8\text{ V}, I_C = 25\text{ mA}$			8.0	
hFE	Forward Current Transfer Ratio: $V_{CE} = 8\text{ V}, I_C = 10\text{ mA}$		30	150	300
I _{CBO}	Collector Cutoff Current: $V_{CB} = 8\text{ V}$				0.2
I _{EBO}	Emitter Cutoff Current: $V_{EB} = 1\text{ V}$				1.0
CCB	Collector Base Capacitance ¹ : $V_{CB} = 8\text{ V}, f = 1\text{ MHz}$			0.2	

Note: 1. For this test the emitter is grounded.

AT-41435 Low Noise Silicon Bipolar Transistor

Absolute Maximum Ratings

Parameter	Symbol	Absolute Maximum ¹
Emitter-Base Voltage	V_{EBO}	1.5 V
Collector-Base Voltage	V_{CBO}	20 V
Collector-Emitter Voltage	V_{CEO}	12 V
Collector Current	I_C	60 mA
Power Dissipation ^{2,3}	P_T	500 mW
Junction Temperature	T_j	200°C
Storage Temperature ⁴	T_{STG}	-65°C to 200°C

Thermal Resistance^{2,5}: $\theta_{jC} = 200^\circ/W$

Notes:

1. Operation of this device above any one of these parameters may cause permanent damage.
2. $T_{CASE} = 25^\circ C$.
3. Derate at 5 mW/°C for $T_C > 100^\circ C$.
4. Storage above +150°C may tarnish the leads of this package making it difficult to solder into a circuit. After a device has been soldered into a circuit, it may be safely stored up to 200°C.
5. The small spot size of this technique results in a higher, though more accurate determination of θ_{jC} than do alternate methods. See MEASUREMENTS section "Thermal Resistance" for more information.

Typical Performance, $T_A = 25^\circ C$

(unless otherwise noted)

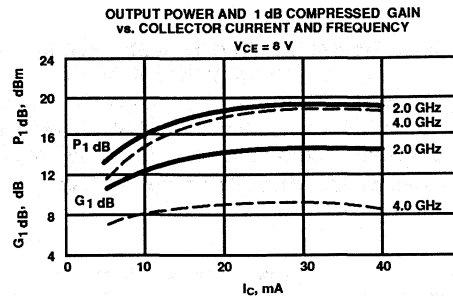

OPTIMUM NOISE FIGURE AND ASSOCIATED GAIN
vs. COLLECTOR CURRENT AND COLLECTOR VOLTAGE
 $f = 2.0 \text{ GHz}$

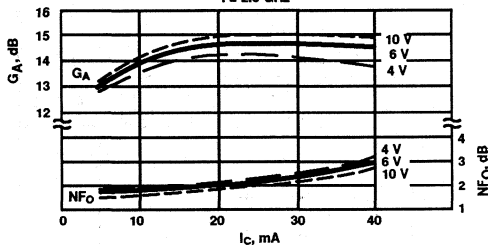

OPTIMUM NOISE FIGURE AND ASSOCIATED GAIN
vs. COLLECTOR CURRENT AND FREQUENCY
 $V_{CE} = 8 V$

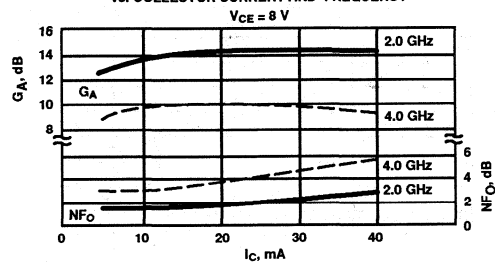

INSERTION POWER GAIN, MAXIMUM AVAILABLE
GAIN AND MAXIMUM STABLE GAIN vs. FREQUENCY
 $V_{CE} = 8 V, I_C = 25 \text{ mA}$

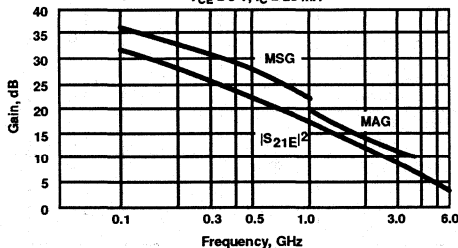

INSERTION POWER GAIN
vs. COLLECTOR CURRENT AND FREQUENCY
 $V_{CE} = 8 V$

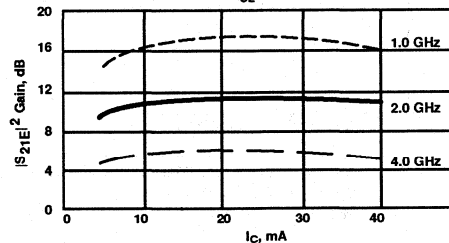

AT-41435
Low Noise Silicon Bipolar Transistor

Typical Scattering Parameters: Common Emitter, $Z_0 = 50 \Omega$

$T_A = 25^\circ\text{C}$, $V_{CE} = 8 \text{ V}$, $I_C = 10 \text{ mA}$

Freq. GHz	S_{11}		S_{21}			S_{12}			S_{22}	
	Mag	Ang	dB	Mag	Ang	dB	Mag	Ang	Mag	Ang
0.1	.80	-32	28.0	24.99	157	-39.2	.011	82	.93	-12
0.5	.50	-110	21.8	12.30	108	-29.6	.033	52	.61	-28
1.0	.40	-152	16.6	6.73	85	-26.2	.049	56	.51	-30
1.5	.38	-176	13.3	4.63	71	-24.0	.063	59	.48	-32
2.0	.39	166	11.0	3.54	60	-21.9	.080	58	.46	-37
2.5	.41	156	9.3	2.91	53	-20.4	.095	61	.44	-40
3.0	.44	145	7.9	2.47	43	-18.8	.115	61	.43	-48
3.5	.46	137	6.7	2.15	33	-17.5	.133	58	.43	-58
4.0	.46	127	5.6	1.91	23	-16.0	.153	53	.45	-68
4.5	.47	116	4.7	1.72	13	-15.0	.178	50	.46	-75
5.0	.49	104	4.0	1.58	3	-13.9	.201	47	.48	-82
5.5	.52	91	3.3	1.45	-7	-13.0	.224	40	.47	-89
6.0	.59	81	2.5	1.34	-17	-12.1	.247	36	.43	-101

$T_A = 25^\circ\text{C}$, $V_{CE} = 8 \text{ V}$, $I_C = 25 \text{ mA}$

0.1	.63	-50	31.8	39.08	146	-40.0	.010	83	.84	-18
0.5	.39	-137	22.9	13.97	99	-31.4	.027	60	.50	-26
1.0	.36	-171	17.2	7.28	80	-27.1	.044	67	.45	-26
1.5	.36	171	13.9	4.94	68	-23.5	.067	66	.43	-30
2.0	.38	156	11.5	3.76	58	-21.6	.083	63	.41	-34
2.5	.40	149	9.8	3.08	52	-19.6	.105	63	.39	-38
3.0	.43	140	8.3	2.61	43	-18.3	.122	64	.38	-47
3.5	.45	132	7.2	2.28	33	-16.8	.144	59	.39	-57
4.0	.46	122	6.1	2.02	23	-15.6	.165	55	.40	-67
4.5	.46	112	5.2	1.82	14	-14.6	.185	50	.42	-75
5.0	.47	101	4.4	1.66	4	-13.7	.207	45	.43	-81
5.5	.51	89	3.7	1.54	-5	-12.6	.233	39	.42	-89
6.0	.58	79	3.0	1.41	-15	-11.8	.257	33	.37	-101

A model for this device is available in the DEVICE MODELS section.

Features

- **Low Noise Figure:** 1.6 dB typical at 2.0 GHz
3.0 dB typical at 4.0 GHz
- **High Associated Gain:** 14.5 dB typical at 2.0 GHz
10.5 dB typical at 4.0 GHz
- **High Gain-Bandwidth Product:** 8.0 GHz typical f_T
- **Hermetic, Gold-ceramic Microstrip Package**

Description

Avantek's AT-41470 is a high performance NPN silicon bipolar transistor housed in a hermetic, high reliability package. This device is designed for use in low noise, wide band amplifier and oscillator applications operating over VHF, UHF and microwave frequencies.

Excellent device uniformity, performance and reliability are produced by the use of ion-implantation, self-alignment techniques, and gold metallization in the fabrication of these devices.

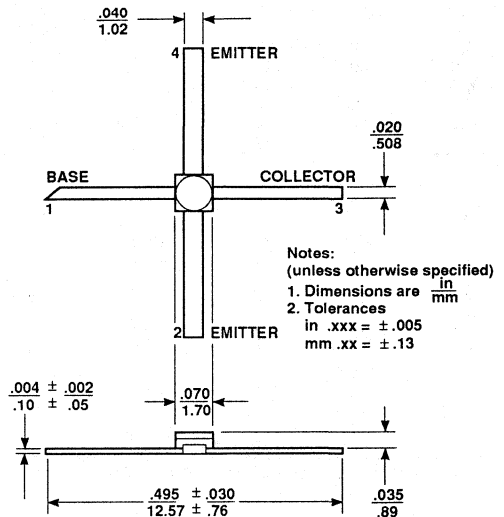
Avantek 70 mil Package

NOISE FIGURE AND ASSOCIATED GAIN vs. FREQUENCY
 $V_{CE} = 8 \text{ V}, I_C = 10 \text{ mA}$

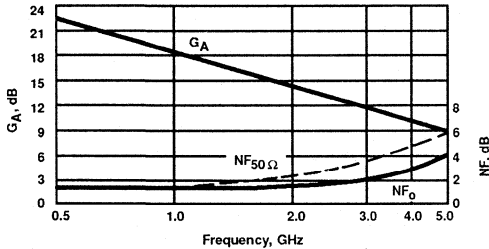

Noise Parameters: $V_{CE} = 8 \text{ V}, I_C = 10 \text{ mA}$

Freq. GHz	NF ₀ dB	Gamma Opt Mag	Ang	R _N /50
0.1	1.2	.12	5	0.17
0.5	1.2	.11	17	0.17
1.0	1.3	.06	35	0.17
2.0	1.6	.21	160	0.16
4.0	3.0	.45	-150	0.20

Electrical Specifications, $T_A = 25^\circ\text{C}$

Symbol	Parameters and Test Conditions	Units	Min.	Typ.	Max.
NF ₀	Optimum Noise Figure: $V_{CE} = 8 \text{ V}, I_C = 10 \text{ mA}$				
	$f = 1.0 \text{ GHz}$	dB		1.3	1.9
	$f = 2.0 \text{ GHz}$			1.6	
	$f = 4.0 \text{ GHz}$			3.0	
G _A	Gain @ NF ₀ : $V_{CE} = 8 \text{ V}, I_C = 10 \text{ mA}$				
	$f = 1.0 \text{ GHz}$	dB	13.0	18.5	
	$f = 2.0 \text{ GHz}$			14.5	
	$f = 4.0 \text{ GHz}$			10.5	
S ₂₁ ²	Insertion Power Gain: $V_{CE} = 8 \text{ V}, I_C = 25 \text{ mA}$				
	$f = 2.0 \text{ GHz}$	dB		12.0	
	$f = 4.0 \text{ GHz}$			6.5	
P ₁ dB	Power Output @ 1 dB Gain Compression: $V_{CE} = 8 \text{ V}, I_C = 25 \text{ mA}$				
	$f = 2.0 \text{ GHz}$	dBm		19.0	
	$f = 4.0 \text{ GHz}$			18.5	
G ₁ dB	1 dB Compressed Gain: $V_{CE} = 8 \text{ V}, I_C = 25 \text{ mA}$				
	$f = 2.0 \text{ GHz}$	dB		15.0	
	$f = 4.0 \text{ GHz}$			10.5	
f_T	Gain Bandwidth Product: $V_{CE} = 8 \text{ V}, I_C = 25 \text{ mA}$				
		GHz		8.0	
hFE	Forward Current Transfer Ratio: $V_{CE} = 8 \text{ V}, I_C = 10 \text{ mA}$				
			30	150	300
I _{CBO}	Collector Cutoff Current: $V_{CB} = 8 \text{ V}$				
		μA			0.2
I _{EBO}	Emitter Cutoff Current: $V_{EB} = 1 \text{ V}$				
		μA			1.0
CCB	Collector Base Capacitance ¹ : $V_{CB} = 8 \text{ V}, f = 1 \text{ MHz}$				
		pF		0.2	

Note: 1. For this test, the emitter is grounded.

Absolute Maximum Ratings

Parameter	Symbol	Absolute Maximum
Emitter-Base Voltage	VEBO	1.5 V
Collector-Base Voltage	VCBO	20 V
Collector-Emitter Voltage	VCEO	12 V
Collector Current	IC	60 mA
Power Dissipation ^{2,3}	PT	500 mW
Junction Temperature	Tj	200°C
Storage Temperature	TSTG	-65°C to 200°C

Thermal Resistance^{2,4}: $\theta_{jc} = 175^\circ\text{C/W}$

Notes:

1. Operation of this device above any one of these parameters may cause permanent damage.
2. TCASE = 25°C.
3. Derate at 5.7 mW/°C for TC > 113°C.
4. The small spot size of this technique results in a higher, though more accurate determination of θ_{jc} than do alternate methods. See MEASUREMENTS section "Thermal Resistance" for more information.

Typical Performance, TA = 25°C

(unless otherwise noted)

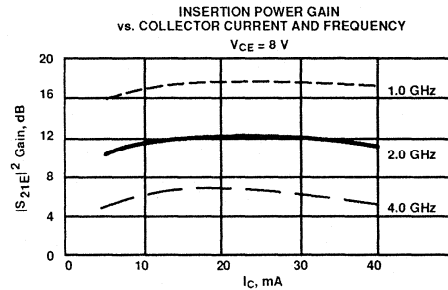
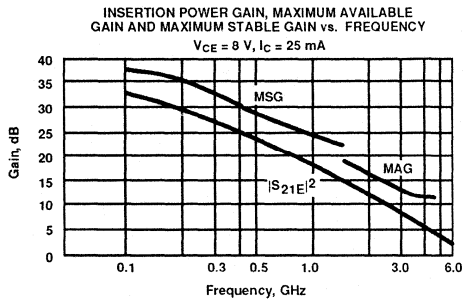
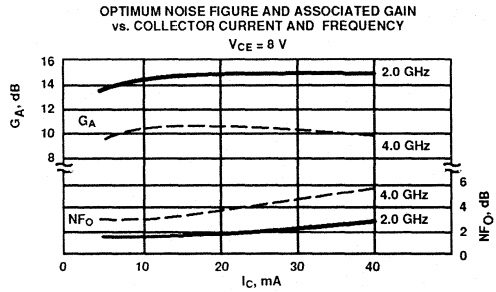
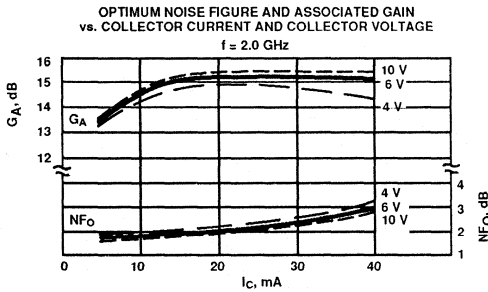
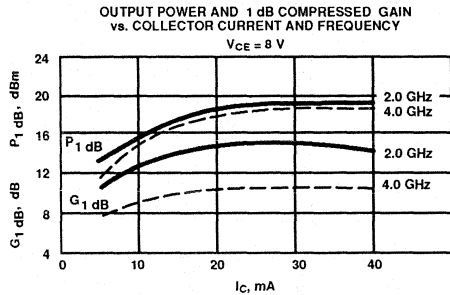

AT-41470
Low Noise Silicon Bipolar Transistor

Typical Scattering Parameters: Common Emitter, $Z_0 = 50 \Omega$

$T_A = 25^\circ\text{C}$, $V_{CE} = 8 \text{ V}$, $I_C = 10 \text{ mA}$

Freq. GHz	S ₁₁		S ₂₁			S ₁₂			S ₂₂	
	Mag	Ang	dB	Mag	Ang	dB	Mag	Ang	Mag	Ang
0.1	.79	-37	28.4	26.27	157	-39.2	.011	57	.94	-13
0.5	.65	-120	22.3	13.05	110	-30.8	.029	40	.62	-30
1.0	.61	-155	17.1	7.17	88	-28.9	.036	41	.52	-32
1.5	.60	-172	13.9	4.93	76	-27.5	.042	46	.50	-36
2.0	.60	176	11.5	3.75	65	-26.4	.048	46	.50	-40
2.5	.61	169	9.7	3.06	59	-26.0	.050	58	.48	-41
3.0	.62	161	8.3	2.59	51	-24.7	.058	61	.49	-48
3.5	.61	154	7.0	2.24	42	-23.2	.069	63	.51	-56
4.0	.60	146	5.9	1.97	32	-21.4	.085	62	.52	-63
4.5	.60	137	4.9	1.77	24	-20.1	.099	59	.55	-69
5.0	.60	127	4.1	1.61	15	-19.5	.106	59	.57	-75
5.5	.61	115	3.4	1.47	6	-18.3	.121	56	.58	-80
6.0	.64	104	2.6	1.34	-4	-17.4	.135	53	.57	-87

$T_A = 25^\circ\text{C}$, $V_{CE} = 8 \text{ V}$, $I_C = 25 \text{ mA}$

0.1	.64	-62	32.5	42.11	147	-40.9	.009	75	.85	-19
0.5	.61	-146	23.7	15.31	100	-34.4	.019	47	.50	-30
1.0	.61	-170	18.1	8.00	83	-30.2	.031	53	.44	-31
1.5	.60	177	14.7	5.42	72	-29.1	.035	62	.44	-34
2.0	.61	167	12.3	4.10	62	-27.1	.044	60	.44	-39
2.5	.61	163	10.4	3.32	58	-25.7	.052	67	.43	-39
3.0	.62	156	9.0	2.81	50	-23.6	.066	67	.44	-46
3.5	.62	150	7.7	2.44	41	-22.6	.074	67	.46	-55
4.0	.62	142	6.6	2.13	32	-21.7	.082	63	.48	-62
4.5	.61	134	5.6	1.91	24	-20.1	.099	62	.50	-68
5.0	.60	123	4.8	1.73	15	-18.9	.113	59	.52	-73
5.5	.61	112	4.0	1.59	6	-18.1	.124	54	.54	-78
6.0	.64	102	3.2	1.45	-3	-17.3	.136	50	.53	-85

A model for this device is available in the DEVICE MODELS section.

Features

- Low Noise Figure: 1.3 dB typical at 0.5 GHz
2.0 dB typical at 1.0 GHz
- High Associated Gain: 14.0 dB typical at 0.5 GHz
10.0 dB typical at 1.0 GHz
- High Gain-Bandwidth Product: 6.5 GHz typical f_T
- Hermetic, Metal Package

Description

Avantek's AT-41472 is a high performance NPN silicon bipolar transistor housed in a hermetic, high reliability metal package. This device is designed for use in low noise, wide band amplifier and oscillator applications operating over VHF, UHF and microwave frequencies.

Excellent device uniformity, performance and reliability are produced by the use of ion-implantation, self-alignment techniques, and gold metallization in the fabrication of these devices.

Avantek TO-72 Package

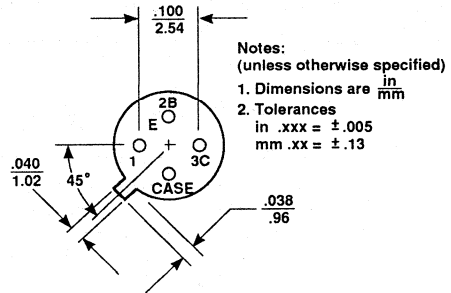
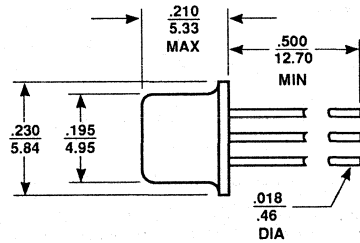

NOISE FIGURE AND ASSOCIATED GAIN
vs. FREQUENCY
 $V_{CE} = 8\text{ V}, I_C = 10\text{ mA}$

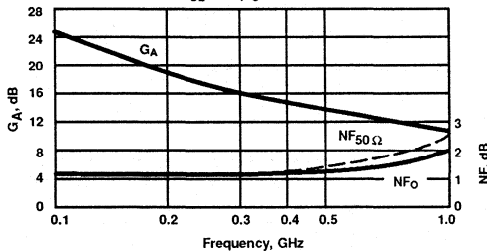

Electrical Specifications, $T_A = 25^\circ\text{C}$

Symbol	Parameters and Test Conditions	Units	Min.	Typ.	Max.
NF ₀	Optimum Noise Figure: $V_{CE} = 8\text{ V}, I_C = 10\text{ mA}$			1.3	1.6
GA	Gain @ NF ₀ : $V_{CE} = 8\text{ V}, I_C = 10\text{ mA}$			14.0	
$ S_{21E} ^2$	Insertion Power Gain: $V_{CE} = 8\text{ V}, I_C = 25\text{ mA}$			16.5	
P ₁ dB	Power Output @ 1 dB Gain Compression: $V_{CE} = 8\text{ V}, I_C = 25\text{ mA}$			20.5	
G ₁ dB	1 dB Compressed Gain: $V_{CE} = 8\text{ V}, I_C = 25\text{ mA}$			7.0	
f_T	Gain Bandwidth Product: $V_{CE} = 8\text{ V}, I_C = 25\text{ mA}$			6.5	
hFE	Forward Current Transfer Ratio: $V_{CE} = 8\text{ V}, I_C = 10\text{ mA}$		30	150	300
ICBO	Collector Cutoff Current: $V_{CB} = 8\text{ V}$	μA			0.2
IEBO	Emitter Cutoff Current: $V_{EB} = 1\text{ V}$	μA			1.0
CCB	Collector Base Capacitance ¹ : $V_{CB} = 8\text{ V}, f = 1\text{ MHz}$	pF		0.35	

Note: 1. For this test, the emitter is grounded.

AT-41472

Low Noise Silicon Bipolar Transistor

Absolute Maximum Ratings

Parameter	Symbol	Absolute Maximum ¹
Emitter-Base Voltage	VEBO	1.5 V
Collector-Base Voltage	VCBO	20 V
Collector-Emitter Voltage	VCEO	12 V
Collector Current	IC	60 mA
Power Dissipation ^{2,3}	PT	500 mW
Junction Temperature	Tj	200°C
Storage Temperature	TSTG	-65°C to 200°C

Thermal Resistance^{2,4}: $\theta_{JC} = 260^\circ\text{C/W}$

Notes:

- Operation of this device above any one of these parameters may cause permanent damage.
- TCASE = 25°C.
- Derate at 3.8 mW/°C for TC > 70°C.
- The small spot size of this technique results in a higher, though more accurate determination of θ_{JC} than do alternate methods. See MEASUREMENTS section "Thermal Resistance" for more information.

Typical Performance, TA = 25°C

(unless otherwise noted)

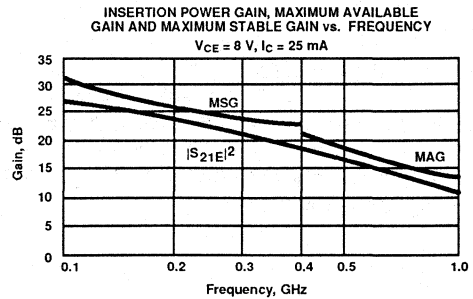

OPTIMUM NOISE FIGURE AND ASSOCIATED GAIN vs. COLLECTOR CURRENT AND COLLECTOR VOLTAGE
VCE = 8 V

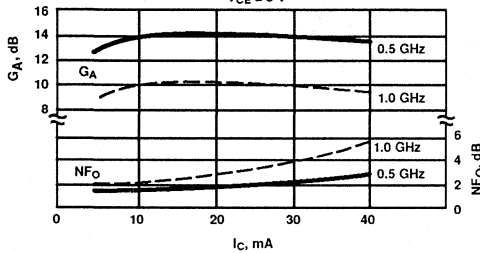

INSERTION POWER GAIN vs. COLLECTOR CURRENT AND FREQUENCY
VCE = 8 V

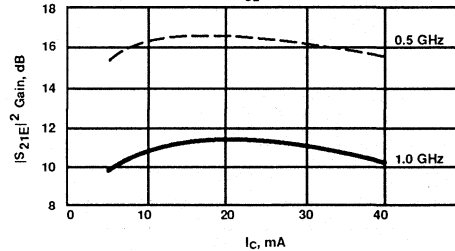

Typical Scattering Parameters: Common Emitter, ZO = 50 Ω

TA = 25°C, VCE = 8 V, IC = 10 mA

Freq. GHz	S11		S21			S12			S22	
	Mag	Ang	dB	Mag	Ang	dB	Mag	Ang	Mag	Ang
0.1	.67	-24	25.1	18.00	144	-35.6	.017	71	.89	-12
0.2	.51	-37	22.3	12.98	122	-30.5	.030	71	.78	-17
0.3	.41	-42	19.9	9.84	110	-28.5	.038	72	.71	-18
0.4	.34	-45	17.9	7.87	101	-26.4	.048	71	.67	-20
0.5	.29	-48	16.4	6.60	94	-24.5	.060	71	.65	-21
0.6	.25	-49	15.0	5.64	87	-22.9	.072	71	.62	-24
0.7	.22	-47	13.8	4.92	82	-21.7	.082	69	.61	-28
0.8	.21	-45	12.7	4.32	76	-21.1	.088	67	.61	-31
0.9	.20	-45	11.6	3.81	70	-20.1	.099	64	.61	-35
1.0	.19	-45	10.8	3.46	67	-19.8	.103	64	.62	-38

TA = 25°C, VCE = 8 V, IC = 25 mA

0.1	.58	-30	26.9	22.02	131	-35.4	.017	78	.78	-15
0.2	.40	-38	23.4	14.70	111	-30.8	.029	80	.68	-17
0.3	.32	-41	20.7	10.79	101	-27.5	.042	79	.64	-18
0.4	.27	-37	18.4	8.26	92	-25.7	.052	76	.61	-17
0.5	.24	-37	16.5	6.71	86	-23.9	.064	73	.57	-18
0.6	.22	-38	15.3	5.82	85	-22.0	.079	74	.56	-22
0.7	.20	-36	14.2	5.15	79	-20.8	.091	72	.54	-26
0.8	.19	-35	13.2	4.56	76	-19.8	.102	71	.53	-30
0.9	.19	-38	12.1	4.01	74	-18.8	.115	72	.56	-33
1.0	.18	-37	11.4	3.71	69	-18.2	.123	69	.56	-34

A model for this device is available in the DEVICE MODELS section.

Features

- Low Noise Figure: 1.4 dB typical at 1.0 GHz
1.7 dB typical at 2.0 GHz
- High Associated Gain: 18.5 dB typical at 1.0 GHz
13.5 dB typical at 2.0 GHz
- High Gain-Bandwidth Product: 8.0 GHz typical fr
- Low Cost Plastic Package

Description

Avantek's AT-41485 is a high performance NPN silicon bipolar transistor housed in a low cost plastic package. This device is designed for use in low noise, wide band amplifier and oscillator applications operating over VHF, UHF and microwave frequencies.

Excellent device uniformity, performance and reliability are produced by the use of ion-implantation, self-alignment techniques, and gold metallization in the fabrication of these devices.

Avantek 85 Plastic Package

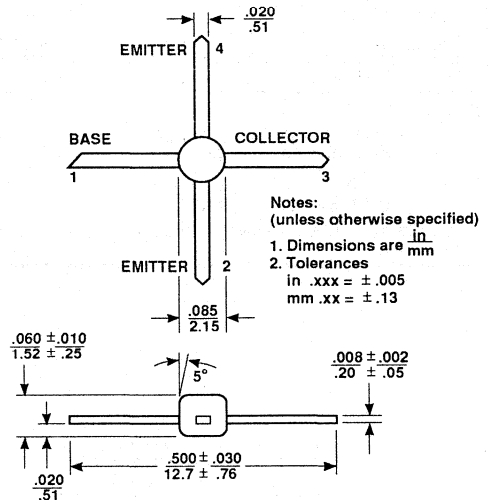

NOISE FIGURE AND ASSOCIATED GAIN
vs. FREQUENCY
 $V_{CE} = 8 \text{ V}, I_C = 10 \text{ mA}$

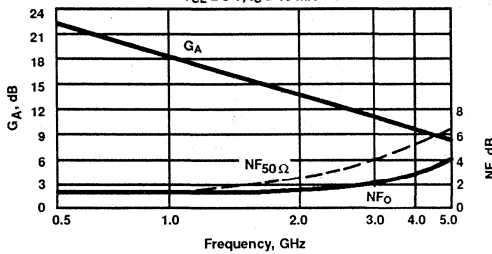

Noise Parameters: $V_{CE} = 8 \text{ V}, I_C = 10 \text{ mA}$

Freq. GHz	NF ₀ dB	Gamma Opt Mag	Ang	R _N /50
0.1	1.3	.12	5	0.17
0.5	1.3	.10	25	0.17
1.0	1.4	.06	50	0.16
2.0	1.7	.25	172	0.16
4.0	3.0	.48	-131	0.24

Electrical Specifications, $T_A = 25^\circ\text{C}$

Symbol	Parameters and Test Conditions	Units	Min.	Typ.	Max.
NF ₀	Optimum Noise Figure: $V_{CE} = 8 \text{ V}, I_C = 10 \text{ mA}$				
G _A	Gain @ NF ₀ : $V_{CE} = 8 \text{ V}, I_C = 10 \text{ mA}$	$f = 1.0 \text{ GHz}$		1.4	1.8
		$f = 2.0 \text{ GHz}$		1.7	
		$f = 4.0 \text{ GHz}$		3.0	
S _{21E} ²	Insertion Power Gain: $V_{CE} = 8 \text{ V}, I_C = 25 \text{ mA}$	$f = 1.0 \text{ GHz}$		17.5	
		$f = 2.0 \text{ GHz}$		11.5	
		$f = 4.0 \text{ GHz}$		9.5	
P ₁ dB	Power Output @ 1 dB Gain Compression: $V_{CE} = 8 \text{ V}, I_C = 25 \text{ mA}$	dBm		18.5	
G ₁ dB	1 dB Compressed Gain: $V_{CE} = 8 \text{ V}, I_C = 25 \text{ mA}$	dB		14.0	
f _T	Gain Bandwidth Product: $V_{CE} = 8 \text{ V}, I_C = 25 \text{ mA}$	GHz		8.0	
hFE	Forward Current Transfer Ratio: $V_{CE} = 8 \text{ V}, I_C = 10 \text{ mA}$		30	150	300
I _{CBO}	Collector Cutoff Current: $V_{CB} = 8 \text{ V}$	μA			0.2
I _{EBO}	Emitter Cutoff Current: $V_{EB} = 1 \text{ V}$	μA			1.0
C _{CB}	Collector Base Capacitance ¹ : $V_{CB} = 8 \text{ V}, f = 1 \text{ MHz}$	pF		0.25	

Note: 1. For this test the emitter is grounded.

AT-41485 Low Noise Silicon Bipolar Transistor

Absolute Maximum Ratings

Parameter	Symbol	Absolute Maximum
Emitter-Base Voltage	VEBO	1.5 V
Collector-Base Voltage	VCEO	20 V
Collector-Emitter Voltage	VCEO	12 V
Collector Current	IC	60 mA
Power Dissipation ^{2,3}	PT	500 mW
Junction Temperature	TJ	150°C
Storage Temperature	TSTG	-65°C to 150°C
Thermal Resistance ^{2,4} : $\theta_{jc} = 155^\circ\text{C/W}$		

Notes:

1. Operation of this device above any one of these parameters may cause permanent damage.
2. TCASE = 25°C.
3. Derate at 6.5 mW/°C for TC > 73°C.
4. See MEASUREMENTS section "Thermal Resistance" for more information.

Typical Performance, TA = 25°C

(unless otherwise noted)

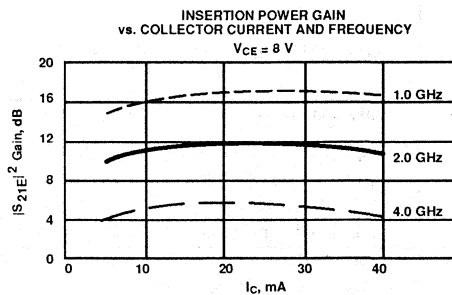
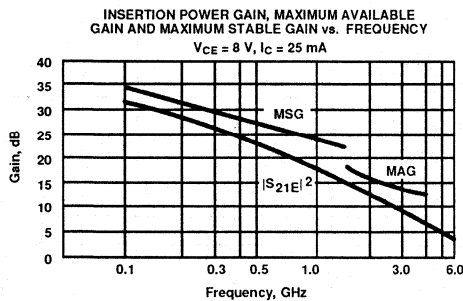
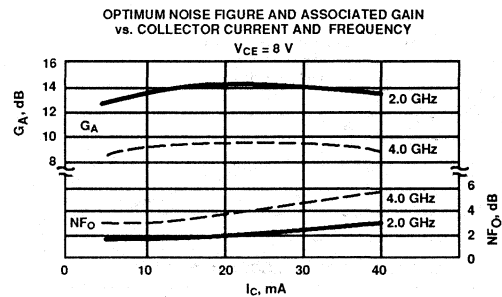
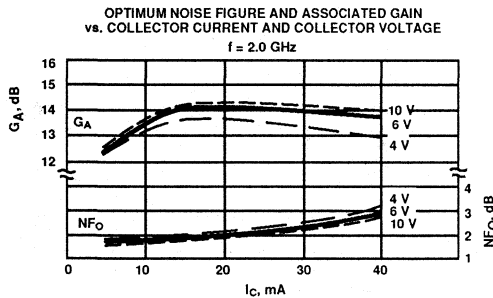
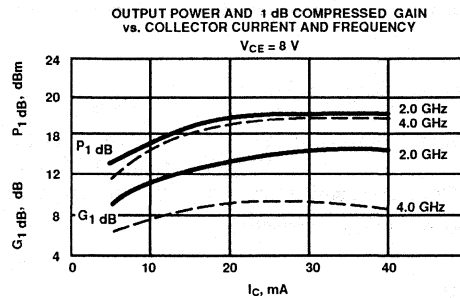

AT-41485
Low Noise Silicon Bipolar Transistor

Typical Scattering Parameters: Common Emitter, $Z_0 = 50 \Omega$

$T_A = 25^\circ\text{C}$, $V_{CE} = 8 \text{ V}$, $I_C = 10 \text{ mA}$

Freq. GHz	S ₁₁		S ₂₁			S ₁₂			S ₂₂	
	Mag	Ang	dB	Mag	Ang	dB	Mag	Ang	Mag	Ang
0.1	.74	-40	28.2	25.80	156	-35.6	.017	81	.93	-14
0.5	.61	-126	21.9	12.46	108	-29.2	.035	44	.57	-31
1.0	.57	-161	16.6	6.80	87	-27.9	.040	38	.46	-33
1.5	.57	-180	13.4	4.67	75	-25.7	.052	47	.43	-34
2.0	.58	166	11.0	3.55	64	-24.5	.060	54	.41	-38
2.5	.59	160	9.3	2.92	59	-23.3	.068	58	.40	-39
3.0	.61	150	7.7	2.42	50	-21.9	.080	63	.39	-46
3.5	.62	142	6.4	2.09	41	-20.8	.091	61	.41	-54
4.0	.62	134	5.3	1.84	32	-19.5	.106	59	.42	-62
4.5	.62	125	4.3	1.65	24	-18.4	.120	57	.43	-67
5.0	.63	115	3.5	1.50	15	-17.2	.138	54	.44	-73
5.5	.65	103	2.7	1.37	6	-16.1	.157	49	.43	-78
6.0	.69	92	1.8	1.24	-4	-15.3	.172	46	.40	-86

$T_A = 25^\circ\text{C}$, $V_{CE} = 8 \text{ V}$, $I_C = 25 \text{ mA}$

0.1	.55	-68	32.0	40.01	146	-40.9	.009	57	.85	-19
0.5	.58	-153	23.1	14.20	99	-32.7	.023	52	.47	-29
1.0	.58	-177	17.4	7.39	82	-29.8	.032	63	.41	-28
1.5	.58	169	14.0	5.01	71	-27.3	.043	60	.39	-30
2.0	.60	158	11.6	3.78	61	-24.6	.059	64	.38	-36
2.5	.60	153	9.8	3.09	58	-23.7	.065	71	.36	-39
3.0	.63	147	8.1	2.55	48	-21.7	.082	68	.35	-47
3.5	.64	140	6.9	2.21	39	-20.7	.092	67	.37	-56
4.0	.64	133	5.8	1.94	31	-19.4	.107	65	.39	-64
4.5	.64	125	4.8	1.74	23	-18.1	.125	63	.40	-71
5.0	.64	115	4.0	1.58	14	-17.1	.140	56	.41	-78
5.5	.66	105	3.2	1.45	5	-15.9	.160	50	.40	-82
6.0	.70	94	2.4	1.32	-5	-15.1	.175	47	.37	-91

A model for this device is available in the DEVICE MODELS section.

Features

- **Low Noise Figure:** 1.4 dB typical at 1.0 GHz
 1.7 dB typical at 2.0 GHz
- **High Associated Gain:** 18.0 dB typical at 1.0 GHz
 13.0 dB typical at 2.0 GHz
- **High Gain-Bandwidth Product:** 8.0 GHz typical f_T
- **Surface Mount Plastic Package**
- **Tape-and-Reel Packaging Option Available¹**

Description

Avantek's AT-41486 is a high performance NPN silicon bipolar transistor housed in a low cost, surface mount plastic package. This device is designed for use in low noise, wide band amplifier and oscillator applications operating over VHF, UHF and microwave frequencies.

Excellent device uniformity, performance and reliability are produced by the use of ion-implantation, self-alignment techniques, and gold metallization in the fabrication of these devices.

Avantek 86 Plastic Package

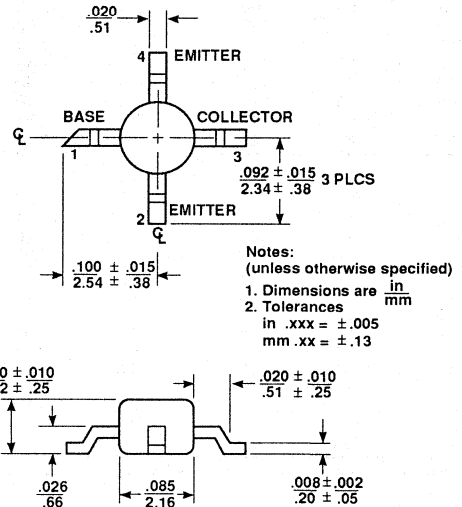

NOISE FIGURE AND ASSOCIATED GAIN vs. FREQUENCY
 $V_{CE} = 8 \text{ V}, I_C = 10 \text{ mA}$

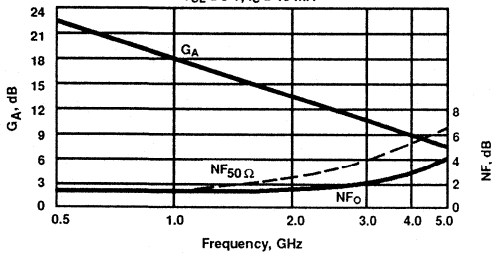

Noise Parameters: $V_{CE} = 8 \text{ V}, I_C = 10 \text{ mA}$

Freq. GHz	NFO dB	Gamma Mag	Opt Ang	RN/50
0.1	1.3	.12	3	0.17
0.5	1.3	.10	16	0.17
1.0	1.4	.04	43	0.16
2.0	1.7	.12	-145	0.16
4.0	3.0	44	-99	0.40

Electrical Specifications, $T_A = 25^\circ\text{C}$

Symbol	Parameters and Test Conditions	Units	Min.	Typ.	Max.	
NFO	Optimum Noise Figure: $V_{CE} = 8 \text{ V}, I_C = 10 \text{ mA}$	$f = 1.0 \text{ GHz}$ $f = 2.0 \text{ GHz}$ $f = 4.0 \text{ GHz}$	dB		1.4 1.7 3.0	1.8
GA	Gain @ NFO: $V_{CE} = 8 \text{ V}, I_C = 10 \text{ mA}$	$f = 1.0 \text{ GHz}$ $f = 2.0 \text{ GHz}$ $f = 4.0 \text{ GHz}$	dB	17.0	18.0 13.0 9.0	
$ S_{21E} ^2$	Insertion Power Gain: $V_{CE} = 8 \text{ V}, I_C = 25 \text{ mA}$	$f = 1.0 \text{ GHz}$ $f = 2.0 \text{ GHz}$	dB		17.5 11.5	
P_1 dB	Power Output @ 1 dB Gain Compression: $V_{CE} = 8 \text{ V}, I_C = 25 \text{ mA}$	$f = 2.0 \text{ GHz}$	dBm		18.0	
G_1 dB	1 dB Compressed Gain: $V_{CE} = 8 \text{ V}, I_C = 25 \text{ mA}$	$f = 2.0 \text{ GHz}$	dB		13.5	
f_T	Gain Bandwidth Product: $V_{CE} = 8 \text{ V}, I_C = 25 \text{ mA}$		GHz		8.0	
hFE	Forward Current Transfer Ratio: $V_{CE} = 8 \text{ V}, I_C = 10 \text{ mA}$			30	150	300
I_{CBO}	Collector Cutoff Current: $V_{CB} = 8 \text{ V}$		μA			0.2
I_{EBO}	Emitter Cutoff Current: $V_{EB} = 1 \text{ V}$		μA			1.0
CCB	Collector Base Capacitance ² : $V_{CB} = 8 \text{ V}, f = 1 \text{ MHz}$		pF		0.25	

Notes: 1. Refer to PACKAGING section "Tape-and-Reel Packaging for Surface Mount Semiconductors".
 2. For this test, the emitter is grounded.

Absolute Maximum Ratings

Parameter	Symbol	Absolute Maximum ¹
Emitter-Base Voltage	VEBO	1.5 V
Collector-Base Voltage	VCBO	20 V
Collector-Emitter Voltage	VCEO	12 V
Collector Current	IC	60 mA
Power Dissipation ^{2,3}	PT	500 mW
Junction Temperature	TJ	150°C
Storage Temperature	TSTG	-65°C to 150°C

Thermal Resistance^{2,4}: $\theta_{jC} = 165^\circ\text{C/W}$

Notes:

1. Operation of this device above any one of these parameters may cause permanent damage.
2. TCASE = 25°C.
3. Derate at 6 mW/°C for TC > 68°C.
4. See MEASUREMENTS section "Thermal Resistance" for more information.

Part Number Ordering Information

Part Number	Devices Per Reel	Reel Size
AT-41486-TR1	1000	7"
AT-41486-TR2	4000	13"

Typical Performance, TA = 25°C

(unless otherwise noted)

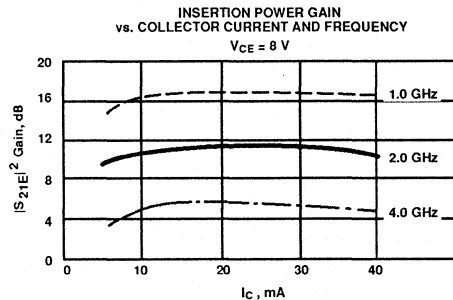
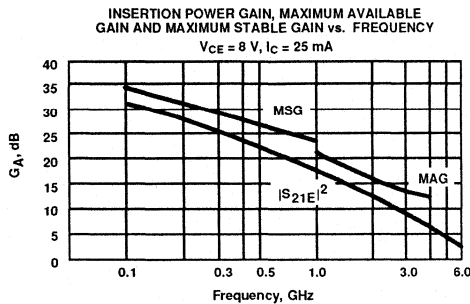
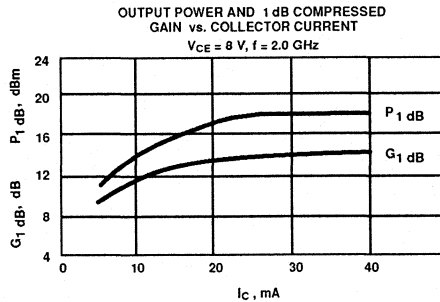
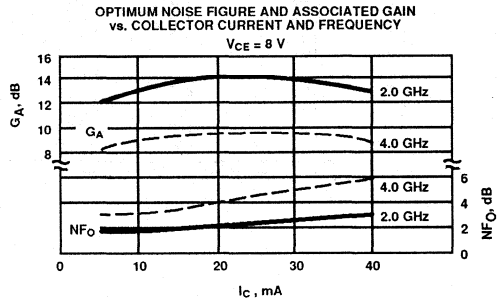
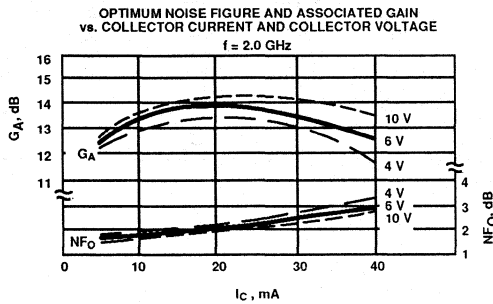

AT-41486
Low Noise Silicon Bipolar Transistor

Typical Scattering Parameters: Common Emitter, $Z_O = 50 \Omega$

$T_A = 25^\circ\text{C}$, $V_{CE} = 8 \text{ V}$, $I_C = 10 \text{ mA}$

Freq. GHz	S_{11}		S_{21}			S_{12}			S_{22}	
	Mag	Ang	dB	Mag	Ang	dB	Mag	Ang	Mag	Ang
0.1	.74	-38	28.1	25.46	157	-39.6	.011	68	.94	-12
0.5	.59	-127	22.0	12.63	107	-30.2	.031	47	.60	-29
1.0	.56	-168	16.8	6.92	84	-27.7	.041	46	.49	-29
1.5	.57	169	13.5	4.72	69	-26.2	.049	49	.45	-32
2.0	.62	152	11.1	3.61	56	-24.8	.058	43	.42	-39
2.5	.63	142	9.3	2.91	47	-23.4	.068	52	.40	-42
3.0	.64	130	7.6	2.41	37	-22.2	.078	52	.39	-50
3.5	.68	122	6.3	2.06	26	-20.6	.093	51	.37	-60
4.0	.71	113	5.1	1.80	16	-19.5	.106	48	.35	-70
4.5	.74	105	4.0	1.59	7	-18.0	.125	48	.35	-84
5.0	.77	99	3.1	1.42	-4	-17.2	.139	43	.35	-98
5.5	.79	93	2.0	1.27	-13	-16.3	.153	38	.35	-114
6.0	.81	87	1.1	1.13	-22	-15.4	.170	34	.35	-131

$T_A = 25^\circ\text{C}$, $V_{CE} = 8 \text{ V}$, $I_C = 25 \text{ mA}$

0.1	.50	-75	32.0	40.01	142	-41.3	.009	54	.85	-17
0.5	.55	-158	23.2	14.38	97	-34.1	.020	48	.51	-24
1.0	.57	177	17.5	7.50	78	-29.9	.032	61	.46	-24
1.5	.57	161	14.1	5.07	65	-27.3	.043	62	.44	-28
2.0	.59	148	11.5	3.75	53	-24.8	.058	59	.43	-35
2.5	.61	139	9.6	3.02	45	-22.9	.072	58	.40	-41
3.0	.65	128	8.0	2.52	34	-21.6	.083	57	.38	-49
3.5	.70	121	6.7	2.17	24	-20.1	.099	56	.36	-59
4.0	.74	113	5.7	1.92	14	-18.8	.115	52	.34	-72
4.5	.78	107	4.7	1.72	3	-17.6	.132	47	.32	-87
5.0	.78	102	3.7	1.53	-8	-16.6	.149	42	.31	-106
5.5	.78	96	2.7	1.36	-19	-15.4	.169	36	.31	-125
6.0	.76	91	1.6	1.21	-29	-14.5	.188	31	.33	-144

A model for this device is available in the DEVICE MODELS section.

Features

- **High Output Power:**
 21.0 dBm typical $P_{1\text{ dB}}$ at 2.0 GHz
 20.5 dBm typical $P_{1\text{ dB}}$ at 4.0 GHz
- **High Gain at 1 dB Compression:**
 15.0 dB typical $G_{1\text{ dB}}$ at 2.0 GHz
 10.0 dB typical $G_{1\text{ dB}}$ at 4.0 GHz
- **Low Noise Figure:**
 1.9 dB typical NF_0 at 2.0 GHz
- **High Gain-Bandwidth Product:**
 9.0 GHz typical f_T

Description

Avantek's AT-42000 is a high performance NPN silicon bipolar transistor chip designed for use in medium power, wide band amplifier and oscillator applications operating over VHF, UHF and microwave frequencies.

The die are nitride-passivated for surface protection. Excellent device uniformity, performance and reliability are produced by the use of ion-implantation, self alignment techniques, and gold metallization in the fabrication of these devices.

The recommended assembly procedure is gold-eutectic die attach at 400°C and either wedge or ball bonding using 0.7 mil gold wire. See also "Chip Use" in the APPLICATIONS section.

Avantek Chip Outline

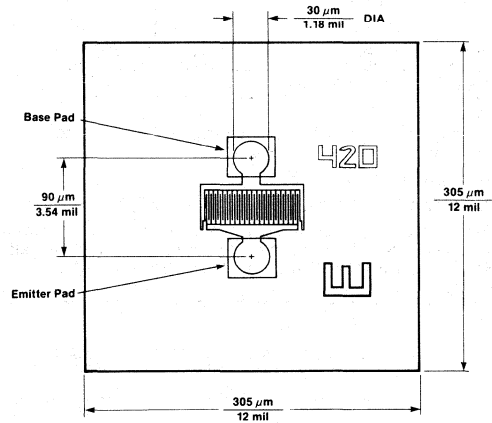

Noise Parameters: $V_{CE} = 8\text{ V}$, $I_C = 10\text{ mA}$

Freq. GHz	NF_0 dB	Gamma Mag	Opt Ang	$R_N/50$
0.1	1.0	.04	13	0.13
0.5	1.1	.05	69	0.13
1.0	1.5	.09	127	0.12
2.0	1.9	.23	171	0.11
4.0	3.0	.47	-154	0.14

Electrical Specifications, $T_A = 25^\circ\text{C}$

Symbol	Parameters and Test Conditions ¹	Units	Min.	Typ.	Max.
$ S_{21E} ^2$	Insertion Power Gain: $V_{CE} = 8\text{ V}$, $I_C = 35\text{ mA}$ $f = 2.0\text{ GHz}$ $f = 4.0\text{ GHz}$	dB		11.5 5.5	
$P_{1\text{ dB}}$	Power Output @ 1 dB Gain Compression: $V_{CE} = 8\text{ V}$, $I_C = 35\text{ mA}$ $f = 2.0\text{ GHz}$ $f = 4.0\text{ GHz}$	dBm		21.0 20.5	
$G_{1\text{ dB}}$	1 dB Compressed Gain: $V_{CE} = 8\text{ V}$, $I_C = 35\text{ mA}$ $f = 2.0\text{ GHz}$ $f = 4.0\text{ GHz}$	dB		15.0 10.0	
NF_0	Optimum Noise Figure: $V_{CE} = 8\text{ V}$, $I_C = 10\text{ mA}$ $f = 2.0\text{ GHz}$ $f = 4.0\text{ GHz}$	dB		1.9 3.0	
GA	Gain @ NF_0 : $V_{CE} = 8\text{ V}$, $I_C = 10\text{ mA}$ $f = 2.0\text{ GHz}$ $f = 4.0\text{ GHz}$	dB		14.0 10.5	
f_T	Gain Bandwidth Product: $V_{CE} = 8\text{ V}$, $I_C = 35\text{ mA}$	GHz		9.0	
hFE	Forward Current Transfer Ratio: $V_{CE} = 8\text{ V}$, $I_C = 35\text{ mA}$		30	150	300
I_{CBO}	Collector Cutoff Current: $V_{CB} = 8\text{ V}$	μA			0.2
I_{EBO}	Emitter Cutoff Current: $V_{EB} = 1\text{ V}$	μA			2.0
CCB	Collector Base Capacitance ² : $V_{CB} = 8\text{ V}$, $f = 1\text{ MHz}$	pF		0.23	

Notes: 1. RF performance is determined by packaging and testing 10 devices per wafer.
 2. For this test the emitter is grounded.

AT-42000

Medium Power Silicon Bipolar Transistor

Absolute Maximum Ratings

Parameter	Symbol	Absolute Maximum ¹
Emitter-Base Voltage	VEBO	1.5 V
Collector-Base Voltage	VCBO	20 V
Collector-Emitter Voltage	VCEO	12 V
Collector Current	IC	80 mA
Power Dissipation ^{2,3}	PT	600 mW
Junction Temperature	Tj	200°C
Storage Temperature	TSTG	-65°C to 200°C

Thermal Resistance^{2,4}: $\theta_{jc} = 70^\circ\text{C/W}$

Notes:

- Operation of this device above any one of these parameters may cause permanent damage.
- T_{MOUNTING SURFACE} = 25°C.
- Derate at 14.3 mW/°C for T_{MOUNTING SURFACE} > 158°C.
- The small spot size of this technique results in a higher, though more accurate determination of θ_{jc} than do alternate methods. See MEASUREMENTS section "Thermal Resistance" for more information.

Part Number Ordering Information

Part Number	Devices Per Tray
AT-42000-GP2	10
AT-42000-GP4	100
AT-42000-GP6	up to 300

Typical Performance, T_A = 25°C

(unless otherwise noted)

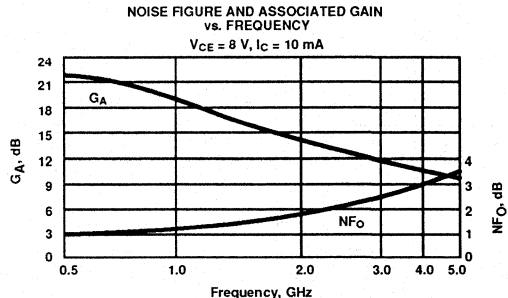
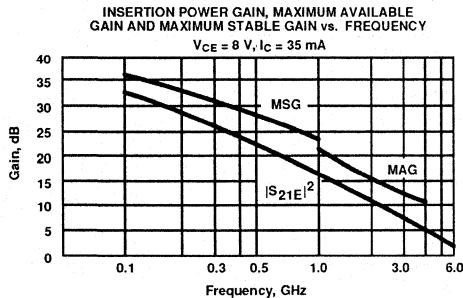
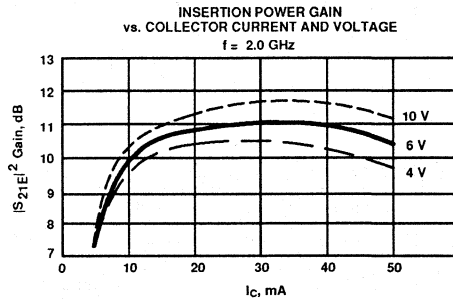
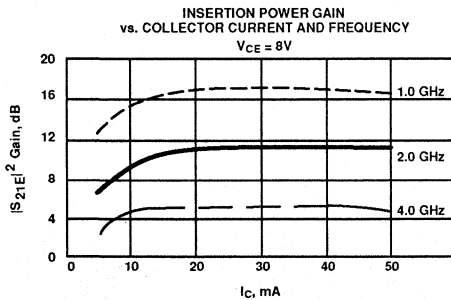
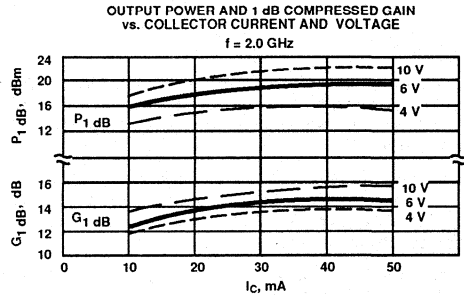
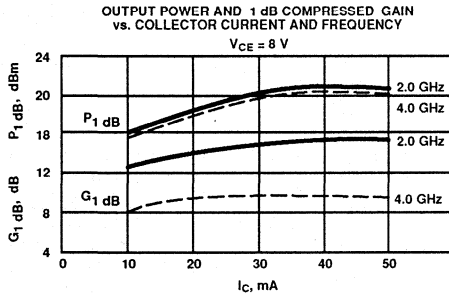

AT-42000
Medium Power Silicon Bipolar Transistor

Typical Scattering Parameters: Common Emitter, $Z_O = 50 \Omega$

$T_A = 25^\circ\text{C}$, $V_{CE} = 8 \text{ V}$, $I_C = 10 \text{ mA}$

Freq. GHz	S ₁₁		S ₂₁			S ₁₂			S ₂₂	
	Mag	Ang	dB	Mag	Ang	dB	Mag	Ang	Mag	Ang
0.1	.70	-50	28.0	25.19	155	-37.7	.013	71	.92	-14
0.5	.67	-136	20.9	11.04	108	-30.5	.030	43	.57	-27
1.0	.66	-166	15.7	6.08	90	-28.9	.036	47	.50	-24
1.5	.66	-173	12.1	4.02	86	-28.2	.039	52	.48	-23
2.0	.66	179	9.8	3.09	82	-27.5	.042	57	.47	-23
2.5	.67	170	7.8	2.46	74	-26.0	.050	66	.47	-23
3.0	.67	165	6.3	2.08	68	-24.7	.058	72	.47	-26
3.5	.70	157	5.1	1.80	61	-23.4	.068	77	.47	-28
4.0	.70	151	3.9	1.56	57	-21.8	.081	82	.48	-30
4.5	.71	145	2.9	1.40	51	-20.7	.092	86	.50	-34
5.0	.73	138	1.9	1.24	41	-19.3	.109	87	.51	-38
5.5	.74	132	1.2	1.15	36	-17.2	.138	88	.51	-50
6.0	.76	129	0.2	1.02	32	-16.3	.154	87	.53	-56

$T_A = 25^\circ\text{C}$, $V_{CE} = 8 \text{ V}$, $I_C = 35 \text{ mA}$

0.1	.49	-96	33.0	44.61	143	-40.9	.009	65	.79	-24
0.5	.62	-163	22.8	13.87	98	-34.4	.019	58	.42	-26
1.0	.63	179	17.2	7.25	86	-30.5	.030	70	.38	-22
1.5	.63	171	13.5	4.74	78	-27.7	.041	76	.38	-23
2.0	.65	163	11.2	3.62	72	-25.4	.054	79	.38	-25
2.5	.65	159	9.3	2.90	67	-23.6	.066	82	.38	-27
3.0	.68	154	7.8	2.44	60	-22.1	.079	82	.38	-29
3.5	.67	148	6.5	2.12	57	-20.6	.093	84	.39	-32
4.0	.69	144	5.3	1.83	51	-19.7	.104	86	.40	-34
4.5	.70	139	4.4	1.65	47	-18.3	.121	86	.41	-40
5.0	.70	137	3.3	1.46	43	-17.5	.133	85	.42	-44
5.5	.72	131	2.7	1.36	38	-16.5	.149	86	.41	-48
6.0	.74	128	1.7	1.22	34	-15.7	.164	85	.44	-55

A model for this device is available in the DEVICE MODELS section.

Features

- **High Output Power:**
 12.0 dBm typical $P_{1\text{ dB}}$ at 2.0 GHz
 20.5 dBm typical $P_{1\text{ dB}}$ at 4.0 GHz
- **High Gain at 1 dB Compression:**
 14.0 dB typical $G_{1\text{ dB}}$ at 2.0 GHz
 9.5 dB typical $G_{1\text{ dB}}$ at 4.0 GHz
- **Low Noise Figure:**
 1.9 dB typical NF_0 at 2.0 GHz
- **High Gain-Bandwidth Product:**
 8.0 GHz typical f_T
- **Hermetic Gold-ceramic Microstrip Package**

Description

Avantek's AT-42010 is a high performance NPN silicon bipolar transistor housed in a hermetic, high reliability package. This device is designed for use in medium power, wide band amplifier and oscillator applications operating over VHF, UHF and microwave frequencies.

Excellent device uniformity, performance and reliability are produced by the use of ion-implantation, self-alignment techniques, and gold metallization in the fabrication of these devices.

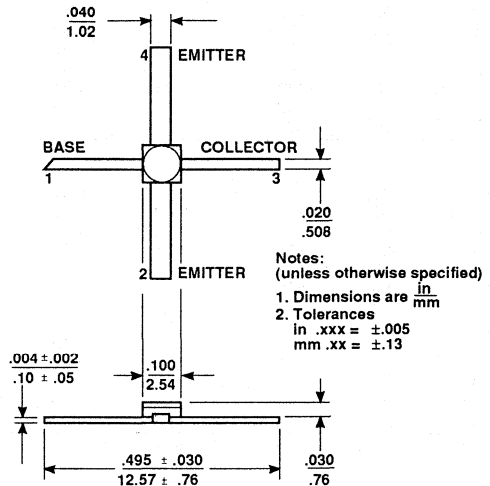
Avantek 100 mil Package

Noise Parameters: $V_{CE} = 8\text{ V}$, $I_C = 10\text{ mA}$

Freq. GHz	NF_0 dB	Gamma Mag	Opt Ang	$R_N/50$
0.1	1.0	.04	15	0.13
0.5	1.1	.05	76	0.12
1.0	1.5	.10	132	0.12
2.0	1.9	.23	-177	0.11
4.0	3.0	.45	-125	0.26

Electrical Specifications, $T_A = 25^\circ\text{C}$

Symbol	Parameters and Test Conditions	Units	Min.	Typ.	Max.
$ S_{21E} ^2$	Insertion Power Gain: $V_{CE} = 8\text{ V}$, $I_C = 35\text{ mA}$ $f = 2.0\text{ GHz}$ $f = 4.0\text{ GHz}$	dB	10.5	11.5 5.5	
$P_{1\text{ dB}}$	Power Output @ 1 dB Gain Compression: $V_{CE} = 8\text{ V}$, $I_C = 35\text{ mA}$ $f = 2.0\text{ GHz}$ $f = 4.0\text{ GHz}$	dBm		21.0 20.5	
$G_{1\text{ dB}}$	1 dB Compressed Gain: $V_{CE} = 8\text{ V}$, $I_C = 35\text{ mA}$ $f = 2.0\text{ GHz}$ $f = 4.0\text{ GHz}$	dB		14.0 9.5	
NF_0	Optimum Noise Figure: $V_{CE} = 8\text{ V}$, $I_C = 10\text{ mA}$ $f = 2.0\text{ GHz}$ $f = 4.0\text{ GHz}$	dB		1.9 3.0	
G_A	Gain @ NF_0 : $V_{CE} = 8\text{ V}$, $I_C = 10\text{ mA}$ $f = 2.0\text{ GHz}$ $f = 4.0\text{ GHz}$	dB		13.5 10.0	
f_T	Gain Bandwidth Product: $V_{CE} = 8\text{ V}$, $I_C = 35\text{ mA}$	GHz		8.0	
h_{FE}	Forward Current Transfer Ratio: $V_{CE} = 8\text{ V}$, $I_C = 35\text{ mA}$		30	150	300
I_{CBO}	Collector Cutoff Current: $V_{CB} = 8\text{ V}$	μA			0.2
I_{EBO}	Emitter Cutoff Current: $V_{EB} = 1\text{ V}$	μA			2.0
C_{CB}	Collector Base Capacitance ¹ : $V_{CB} = 8\text{ V}$, $f = 1\text{ MHz}$	pF		0.28	

Note: 1. For this test the emitter is grounded.

Absolute Maximum Ratings

Parameter	Symbol	Absolute Maximum ¹
Emitter-Base Voltage	VEBO	1.5 V
Collector-Base Voltage	VCBO	20 V
Collector-Emitter Voltage	VCEO	12 V
Collector Current	IC	80 mA
Power Dissipation ^{2,3}	PT	600 mW
Junction Temperature	TJ	200°C
Storage Temperature	TSTG	-65°C to 200°C

Thermal Resistance^{2,4}: $\theta_{JC} = 150^\circ\text{C}/\text{W}$

Notes:

1. Operation of this device above any one of these parameters may cause permanent damage.
2. TCASE = 25°C.
3. Derate at 6.7 mW/°C for TC > 110°C.
4. The small spot size of this technique results in a higher, though more accurate determination of θ_{JC} than do alternate methods. See MEASUREMENTS section "Thermal Resistance" for more information.

Typical Performance, TA = 25°C

(unless otherwise noted)

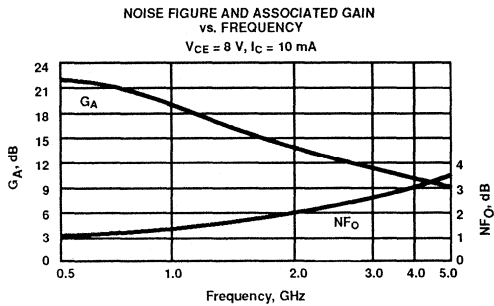
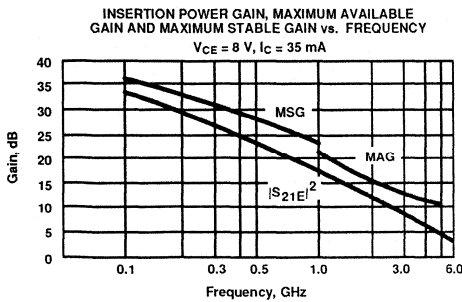
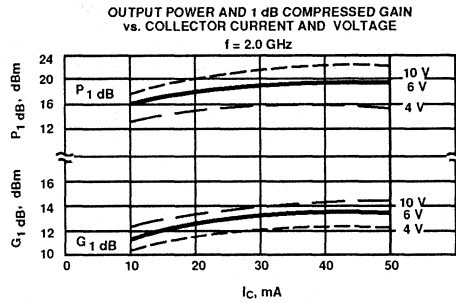
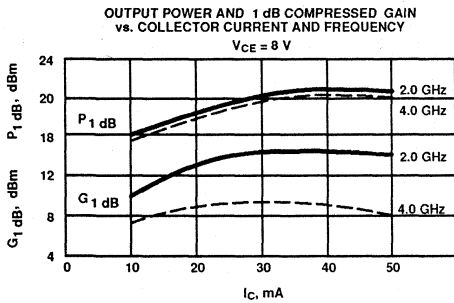
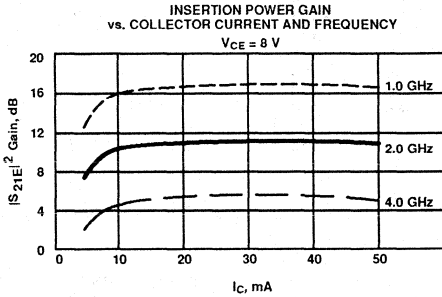

AT-42010
Medium Power Silicon Bipolar Transistor

Typical Scattering Parameters: Common Emitter, $Z_0 = 50 \Omega$

$T_A = 25^\circ\text{C}$, $V_{CE} = 8 \text{ V}$, $I_C = 10 \text{ mA}$

Freq. GHz	S ₁₁		S ₂₁			S ₁₂			S ₂₂	
	Mag	Ang	dB	Mag	Ang	dB	Mag	Ang	Mag	Ang
0.1	.74	-47	28.5	26.65	153	-36.4	.015	72	.91	-18
0.5	.65	-136	21.4	11.71	103	-29.4	.034	38	.51	-39
1.0	.63	-168	15.9	6.24	82	-27.2	.044	36	.40	-42
1.5	.63	174	12.6	4.26	69	-26.0	.050	42	.38	-45
2.0	.63	161	10.1	3.23	57	-24.6	.059	43	.38	-49
2.5	.64	154	8.4	2.64	51	-23.0	.070	52	.38	-51
3.0	.65	145	6.9	2.22	41	-22.0	.080	54	.37	-56
3.5	.66	136	5.8	1.94	31	-21.0	.090	51	.38	-65
4.0	.66	126	4.7	1.72	21	-19.7	.104	50	.39	-74
4.5	.66	115	3.8	1.55	11	-18.0	.126	45	.40	-82
5.0	.66	103	3.0	1.41	1	-17.3	.136	41	.40	-89
5.5	.68	90	2.1	1.28	-9	-16.1	.156	36	.40	-98
6.0	.72	81	1.3	1.16	-19	-15.4	.170	31	.37	-110

$T_A = 25^\circ\text{C}$, $V_{CE} = 8 \text{ V}$, $I_C = 35 \text{ mA}$

0.1	.54	-90	33.3	45.97	138	-39.2	.011	54	.76	-29
0.5	.62	-163	22.8	13.83	94	-33.2	.022	52	.34	-40
1.0	.62	177	17.0	7.10	78	-28.8	.036	59	.30	-40
1.5	.62	166	13.6	4.82	67	-26.2	.049	61	.29	-42
2.0	.62	155	11.3	3.65	56	-23.8	.065	57	.29	-47
2.5	.63	150	9.5	2.99	51	-21.8	.081	62	.29	-50
3.0	.64	142	8.0	2.52	42	-21.0	.090	63	.30	-57
3.5	.65	133	6.8	2.19	32	-19.7	.103	59	.30	-67
4.0	.65	124	5.7	1.93	22	-18.4	.120	54	.31	-76
4.5	.65	113	4.7	1.72	13	-17.2	.138	49	.33	-85
5.0	.66	102	3.9	1.56	3	-16.6	.148	45	.34	-92
5.5	.69	91	3.0	1.41	-6	-15.6	.166	39	.33	-100
6.0	.73	83	2.1	1.27	-16	-14.9	.180	32	.30	-110

A model for this device is available in the DEVICE MODELS section.

Features

- **High Output Power:**
 21.0 dBm typical $P_{1\text{ dB}}$ at 2.0 GHz
 20.5 dBm typical $P_{1\text{ dB}}$ at 4.0 GHz
- **High Gain at 1 dB Compression:**
 14.0 dB typical $G_{1\text{ dB}}$ at 2.0 GHz
 9.5 dB typical $G_{1\text{ dB}}$ at 4.0 GHz
- **Low Noise Figure:**
 1.9 dB typical N_{F0} at 2.0 GHz
- **High Gain-Bandwidth Product:**
 8.0 GHz typical f_T
- **Cost Effective Ceramic Microstrip Package**

Description

Avantek's AT-42035 is a high performance NPN silicon bipolar transistor housed in a cost effective, microstrip package. This device is designed for use in medium power, wide band amplifier and oscillator applications operating over VHF, UHF and microwave frequencies.

Excellent device uniformity, performance and reliability are produced by the use of ion-implantation, self-alignment techniques, and gold metallization in the fabrication of these devices.

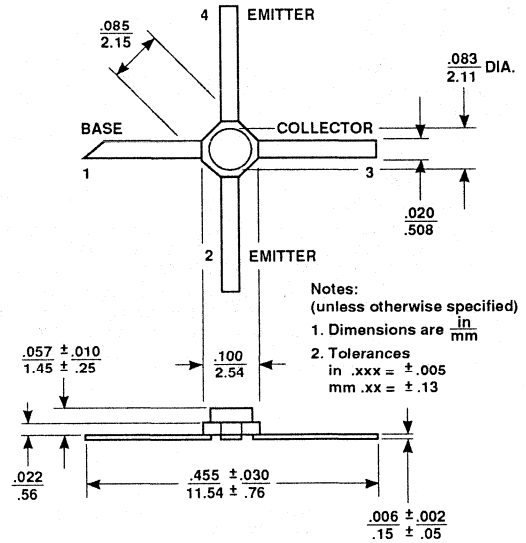
Avantek 35 micro-X Package

Noise Parameters: $V_{CE} = 8\text{ V}$, $I_C = 10\text{ mA}$

Freq. GHz	N_{F0} dB	Gamma Opt Mag	Ang	$R_N/50$
0.1	1.0	.04	10	0.13
0.5	1.1	.04	66	0.12
1.0	1.3	.07	150	0.12
2.0	2.0	.20	-178	0.12
4.0	3.0	.51	-110	0.36

Electrical Specifications, $T_A = 25^\circ\text{C}$

Symbol	Parameters and Test Conditions	Units	Min.	Typ.	Max.
$ S_{21E} ^2$	Insertion Power Gain: $V_{CE} = 8\text{ V}$, $I_C = 35\text{ mA}$ $f = 2.0\text{ GHz}$ $f = 4.0\text{ GHz}$	dB	10.5	11.0 5.0	
$P_{1\text{ dB}}$	Power Output @ 1 dB Gain Compression: $V_{CE} = 8\text{ V}$, $I_C = 35\text{ mA}$ $f = 2.0\text{ GHz}$ $f = 4.0\text{ GHz}$	dBm		21.0 20.5	
$G_{1\text{ dB}}$	1 dB Compressed Gain: $V_{CE} = 8\text{ V}$, $I_C = 35\text{ mA}$ $f = 2.0\text{ GHz}$ $f = 4.0\text{ GHz}$	dB		14.0 9.5	
N_{F0}	Optimum Noise Figure: $V_{CE} = 8\text{ V}$, $I_C = 10\text{ mA}$ $f = 2.0\text{ GHz}$ $f = 4.0\text{ GHz}$	dB		1.9 3.0	
GA	Gain @ N_{F0} : $V_{CE} = 8\text{ V}$, $I_C = 10\text{ mA}$ $f = 2.0\text{ GHz}$ $f = 4.0\text{ GHz}$	dB		13.5 10.0	
f_T	Gain Bandwidth Product: $V_{CE} = 8\text{ V}$, $I_C = 35\text{ mA}$	GHz		8.0	
hFE	Forward Current Transfer Ratio: $V_{CE} = 8\text{ V}$, $I_C = 35\text{ mA}$		30	150	300
I_{CBO}	Collector Cutoff Current: $V_{CB} = 8\text{ V}$	μA			0.2
I_{EBO}	Emitter Cutoff Current: $V_{EB} = 1\text{ V}$	μA			2.0
CCB	Collector Base Capacitance ¹ : $V_{CB} = 8\text{ V}$, $f = 1\text{ MHz}$	pF		0.28	

Note: 1. For this test the emitter is grounded.

AT-42035 Medium Power Silicon Bipolar Transistor

Absolute Maximum Ratings

Parameter	Symbol	Absolute Maximum
Emitter-Base Voltage	V_{EBO}	1.5 V
Collector-Base Voltage	V_{CB0}	20 V
Collector-Emitter Voltage	V_{CE0}	12 V
Collector Current	I_C	80 mA
Power Dissipation ^{2,3}	P_T	600 mW
Junction Temperature	T_J	200°C
Storage Temperature ⁴	T_{STG}	-65°C to 200°C

Thermal Resistance^{2,5}: $\theta_{jC} = 175^\circ\text{C/W}$

Notes:

1. Operation of this device above any one of these parameters may cause permanent damage.
2. $T_{CASE} = 25^\circ\text{C}$.
3. Derate at 5.7 mW/°C for $T_C > 95^\circ\text{C}$.
4. Storage above +150°C may tarnish the leads of this package making it difficult to solder into a circuit. After a device has been soldered into a circuit, it may be safely stored up to 200°C.
5. The small spot size of this technique results in a higher, though more accurate determination of θ_{jC} than do alternate methods. See MEASUREMENTS section "Thermal Resistance" for more information.

Typical Performance, $T_A = 25^\circ\text{C}$

(unless otherwise noted)

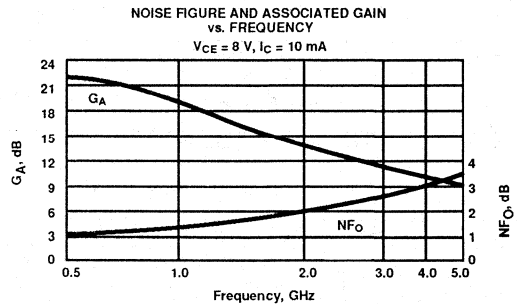
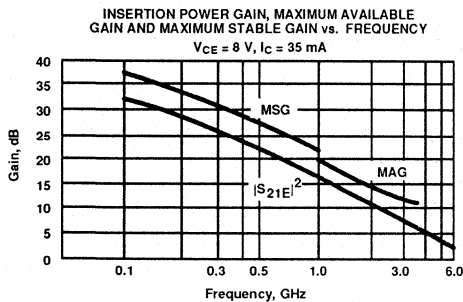
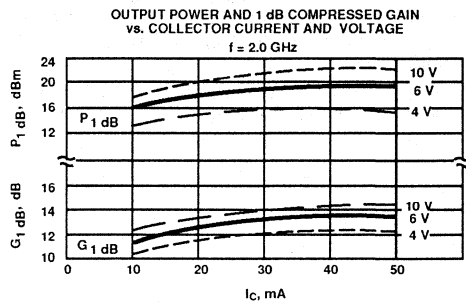
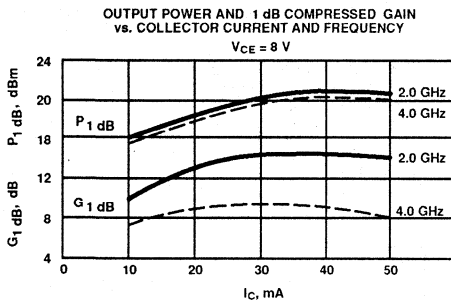
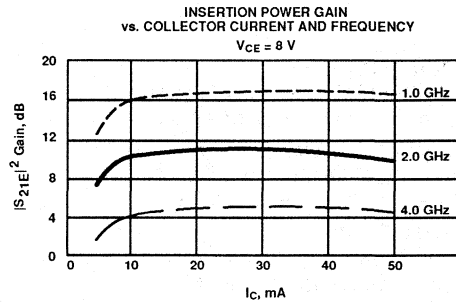

AT-42035
Medium Power Silicon Bipolar Transistor

Typical Scattering Parameters: Common Emitter, $Z_0 = 50 \Omega$

$T_A = 25^\circ\text{C}$, $V_{CE} = 8 \text{ V}$, $I_C = 10 \text{ mA}$

Freq. GHz	S_{11}		S_{21}			S_{12}			S_{22}	
	Mag	Ang	dB	Mag	Ang	dB	Mag	Ang	Mag	Ang
0.1	.72	-46	28.3	26.09	152	-37.0	.014	73	.92	-14
0.5	.59	-137	20.9	11.13	102	-31.0	.028	44	.58	-27
1.0	.56	-171	15.4	5.91	80	-28.2	.039	47	.51	-29
1.5	.56	169	12.1	4.03	67	-26.6	.047	52	.50	-33
2.0	.58	155	9.7	3.06	55	-24.2	.062	55	.48	-38
2.5	.59	147	8.0	2.50	48	-22.6	.074	61	.47	-42
3.0	.61	137	6.5	2.10	38	-20.8	.092	65	.46	-51
3.5	.63	128	5.2	1.82	27	-19.6	.105	62	.47	-63
4.0	.63	117	4.0	1.60	17	-18.0	.126	57	.49	-72
4.5	.63	106	3.1	1.43	7	-16.5	.149	53	.51	-80
5.0	.64	93	2.3	1.30	-3	-15.4	.169	48	.52	-87
5.5	.67	79	1.5	1.19	-13	-14.3	.193	41	.51	-94
6.0	.72	70	0.6	1.07	-23	-13.4	.215	35	.46	-105

$T_A = 25^\circ\text{C}$, $V_{CE} = 8 \text{ V}$, $I_C = 35 \text{ mA}$

0.1	.50	-88	33.2	45.64	135	-42.0	.008	68	.77	-22
0.5	.52	-164	22.4	13.24	92	-32.8	.023	57	.45	-25
1.0	.53	174	16.6	6.75	76	-28.2	.039	63	.42	-26
1.5	.53	160	13.1	4.55	64	-25.6	.053	66	.41	-30
2.0	.55	148	10.8	3.45	53	-23.2	.069	65	.41	-36
2.5	.57	142	9.0	2.81	47	-21.6	.084	67	.39	-40
3.0	.59	134	7.5	2.37	37	-20.0	.101	64	.38	-49
3.5	.60	125	6.3	2.06	27	-18.4	.120	61	.39	-61
4.0	.60	116	5.2	1.81	17	-17.0	.141	57	.41	-71
4.5	.60	104	4.2	1.62	7	-16.0	.158	50	.43	-78
5.0	.61	92	3.4	1.47	-2	-14.9	.179	45	.44	-84
5.5	.64	79	2.6	1.35	-13	-14.1	.198	37	.43	-91
6.0	.69	70	1.7	1.21	-23	-13.2	.219	30	.38	-102

A model for this device is available in the DEVICE MODELS section.

Features

- **High Output Power:**
21.0 dBm typical $P_{1\text{ dB}}$ at 2.0 GHz
20.5 dBm typical $P_{1\text{ dB}}$ at 4.0 GHz
- **High Gain at 1 dB Compression:**
15.0 dB typical $G_{1\text{ dB}}$ at 2.0 GHz
10.0 dB typical $G_{1\text{ dB}}$ at 4.0 GHz
- **Low Noise Figure:**
1.9 dB typical NF_0 at 2.0 GHz
- **High Gain-Bandwidth Product:**
8.0 GHz typical f_T
- **Hermetic Gold-ceramic Microstrip Package**

Description

Avantek's AT-42070 is a high performance NPN silicon bipolar transistor housed in a hermetic high reliability package. This device is designed for use in medium power, wide band amplifier and oscillator applications operating over VHF, UHF and microwave frequencies.

Excellent device uniformity, performance and reliability are produced by the use of ion-implantation, self-alignment techniques, and gold metallization in the fabrication of these devices.

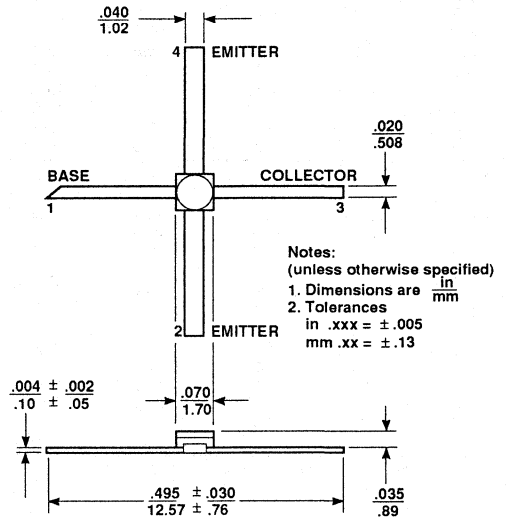
Avantek 70 mil Package

Noise Parameters: $V_{CE} = 8\text{ V}$, $I_C = 10\text{ mA}$

Freq. GHz	NF_0 dB	Gamma Mag	Opt Ang	$R_N/50$
0.1	1.0	.05	15	0.13
0.5	1.1	.06	75	0.13
1.0	1.5	.10	126	0.12
2.0	1.9	.23	172	0.11
4.0	3.0	.45	-145	0.17

Electrical Specifications, $T_A = 25^\circ\text{C}$

Symbol	Parameters and Test Conditions	Units	Min.	Typ.	Max.
$ S_{21E} ^2$	Insertion Power Gain: $V_{CE} = 8\text{ V}$, $I_C = 35\text{ mA}$ $f = 2.0\text{ GHz}$ $f = 4.0\text{ GHz}$	dB	10.5	11.5 5.5	
$P_{1\text{ dB}}$	Power Output @ 1 dB Gain Compression: $V_{CE} = 8\text{ V}$, $I_C = 35\text{ mA}$ $f = 2.0\text{ GHz}$ $f = 4.0\text{ GHz}$	dBm		21.0 20.5	
$G_{1\text{ dB}}$	1 dB Compressed Gain: $V_{CE} = 8\text{ V}$, $I_C = 35\text{ mA}$ $f = 2.0\text{ GHz}$ $f = 4.0\text{ GHz}$	dB		15.0 10.0	
NF_0	Optimum Noise Figure: $V_{CE} = 8\text{ V}$, $I_C = 10\text{ mA}$ $f = 2.0\text{ GHz}$ $f = 4.0\text{ GHz}$	dB		1.9 3.0	
G_A	Gain @ NF_0 : $V_{CE} = 8\text{ V}$, $I_C = 10\text{ mA}$ $f = 2.0\text{ GHz}$ $f = 4.0\text{ GHz}$	dB		14.0 10.5	
f_T	Gain Bandwidth Product: $V_{CE} = 8\text{ V}$, $I_C = 35\text{ mA}$	GHz		8.0	
h_{FE}	Forward Current Transfer Ratio: $V_{CE} = 8\text{ V}$, $I_C = 35\text{ mA}$		30	150	300
I_{CBO}	Collector Cutoff Current: $V_{CB} = 8\text{ V}$	μA			0.2
I_{EBO}	Emitter Cutoff Current: $V_{EB} = 1\text{ V}$	μA			2.0
C_{CB}	Collector Base Capacitance ¹ : $V_{CB} = 8\text{ V}$, $f = 1\text{ MHz}$	pF		0.28	

Note: 1. For this test the emitter is grounded.

Absolute Maximum Ratings

Parameter	Symbol	Absolute Maximum
Emitter-Base Voltage	VEBO	1.5 V
Collector-Base Voltage	VCBO	20 V
Collector-Emitter Voltage	VCEO	12 V
Collector Current	IC	80 mA
Power Dissipation ^{2,3}	PT	600 mW
Junction Temperature	Tj	200°C
Storage Temperature	TSTG	-65°C to 200°C

Thermal Resistance^{2,4}: $\theta_{jc} = 150^\circ\text{C/W}$

Notes:

1. Operation of this device above any one of these parameters may cause permanent damage.
2. TCASE = 25°C.
3. Derate at 6.7 mW/°C for TC > 110°C.
4. The small spot size of this technique results in a higher, though more accurate determination of θ_{jc} than do alternate methods. See MEASUREMENTS section "Thermal Resistance" for more information.

Typical Performance, TA = 25°C

(unless otherwise noted)

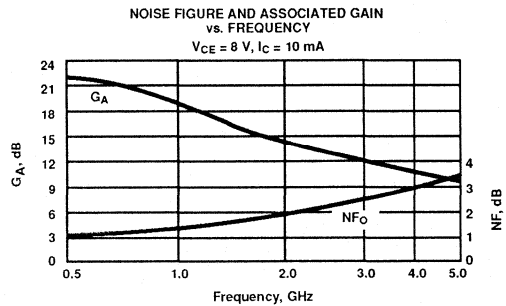
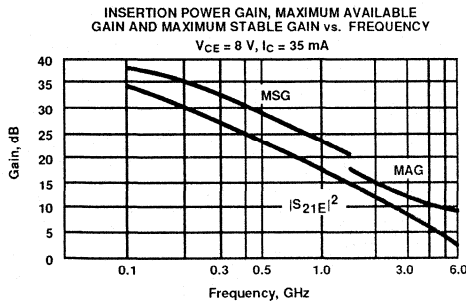
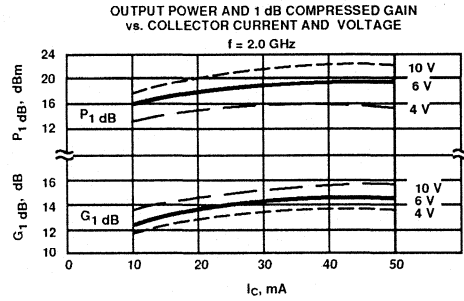
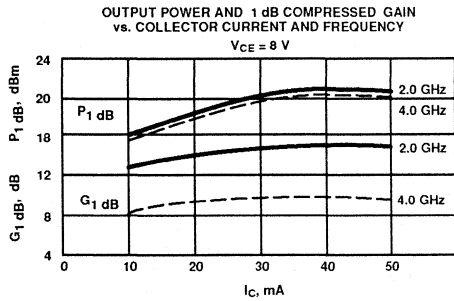
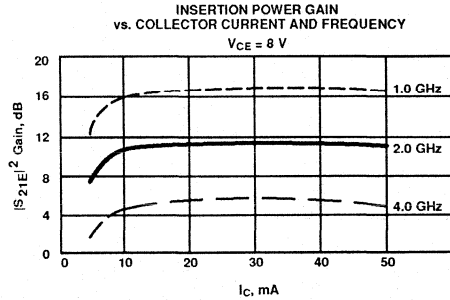

AT-42070
Medium Power Silicon Bipolar Transistor

Typical Scattering Parameters: Common Emitter, $Z_0 = 50 \Omega$

$T_A = 25^\circ\text{C}$, $V_{CE} = 8 \text{ V}$, $I_C = 10 \text{ mA}$

Freq. GHz	S_{11}		S_{21}			S_{12}			S_{22}	
	Mag	Ang	dB	Mag	Ang	dB	Mag	Ang	Mag	Ang
0.1	.70	-49	28.5	26.56	154	-36.0	.016	77	.91	-18
0.5	.69	-137	21.5	11.85	105	-29.6	.033	34	.50	-41
1.0	.69	-165	16.0	6.34	85	-27.2	.044	29	.40	-44
1.5	.68	-179	12.7	4.33	72	-27.4	.043	37	.38	-48
2.0	.69	169	10.3	3.26	62	-25.6	.052	42	.37	-54
2.5	.69	164	8.5	2.64	56	-25.4	.054	46	.37	-55
3.0	.70	157	6.9	2.22	48	-23.8	.065	52	.39	-63
3.5	.70	151	5.6	1.91	39	-22.4	.076	51	.41	-71
4.0	.69	144	4.5	1.68	30	-21.4	.085	55	.43	-77
4.5	.68	137	3.5	1.50	22	-20.4	.096	49	.46	-83
5.0	.68	128	2.7	1.37	14	-19.4	.107	50	.48	-87
5.5	.68	117	2.0	1.26	5	-18.3	.121	45	.48	-91
6.0	.70	107	1.2	1.15	-3	-17.6	.132	44	.48	-98

$T_A = 25^\circ\text{C}$, $V_{CE} = 8 \text{ V}$, $I_C = 35 \text{ mA}$

0.1	.52	-95	33.4	46.52	139	-40.0	.010	50	.77	-29
0.5	.66	-163	23.1	14.33	95	-34.4	.019	46	.34	-42
1.0	.67	179	17.3	7.36	80	-29.6	.033	51	.28	-41
1.5	.67	169	13.9	4.97	69	-28.0	.040	59	.27	-44
2.0	.68	160	11.4	3.74	60	-27.3	.053	59	.27	-51
2.5	.69	157	9.6	3.04	55	-23.8	.065	65	.28	-53
3.0	.69	151	8.1	2.55	47	-22.8	.072	65	.28	-62
3.5	.69	145	6.8	2.20	39	-21.4	.086	59	.30	-72
4.0	.68	139	5.7	1.93	20	-20.2	.097	60	.33	-80
4.5	.67	132	4.7	1.74	22	-19.3	.109	54	.36	-85
5.0	.67	123	4.0	1.59	13	-18.0	.126	50	.38	-90
5.5	.67	113	3.2	1.46	5	-17.2	.138	46	.39	-94
6.0	.69	103	2.5	1.34	-4	-16.4	.152	40	.38	-102

A model for this device is available in the DEVICE MODELS section.

Features

- **High Output Power:**
20.5 dBm typical $P_{1\text{ dB}}$ at 2.0 GHz
- **High Gain at 1 dB Compression:**
14.0 dB typical $G_{1\text{ dB}}$ at 2.0 GHz
- **Low Noise Figure:**
1.9 dB typical N_{F0} at 2.0 GHz
- **High Gain-Bandwidth Product:**
8.0 GHz typical f_T
- **Low Cost Plastic Package**

Description

Avantek's AT-42085 is a high performance NPN silicon bipolar transistor housed in a low cost plastic package. This device is designed for use in medium power, wide band amplifier and oscillator applications operating over VHF, UHF and microwave frequencies.

Excellent device uniformity, performance and reliability are produced by the use of ion-implantation, self-alignment techniques, and gold metallization in the fabrication of these devices.

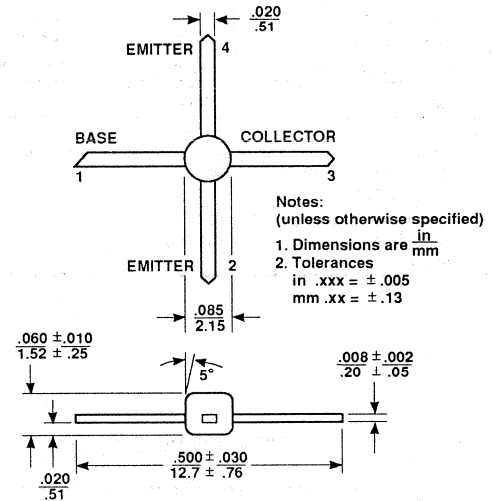
Avantek 85 Plastic Package

Noise Parameters: $V_{CE} = 8\text{ V}$, $I_C = 10\text{ mA}$

Freq. GHz	N_{F0} dB	Gamma Mag	Opt Ang	$R_{N/50}$
0.1	1.1	.05	16	0.13
0.5	1.2	.06	77	0.13
1.0	1.3	.10	131	0.12
2.0	2.0	.24	-179	0.11
4.0	3.5	.46	-128	0.25

Electrical Specifications, $T_A = 25^\circ\text{C}$

Symbol	Parameters and Test Conditions	Units	Min.	Typ.	Max.
$ S_{21E} ^2$	Insertion Power Gain: $V_{CE} = 8\text{ V}$, $I_C = 35\text{ mA}$				
	$f = 1.0\text{ GHz}$	dB	16.0	17.0	
	$f = 2.0\text{ GHz}$			11.0	
	$f = 4.0\text{ GHz}$			5.0	
$P_{1\text{ dB}}$	Power Output @ 1 dB Gain Compression: $V_{CE} = 8\text{ V}$, $I_C = 35\text{ mA}$	dBm		20.5	
				20.0	
$G_{1\text{ dB}}$	1 dB Compressed Gain: $V_{CE} = 8\text{ V}$, $I_C = 35\text{ mA}$	dB		14.0	
	$f = 2.0\text{ GHz}$			9.5	
	$f = 4.0\text{ GHz}$				
N_{F0}	Optimum Noise Figure: $V_{CE} = 8\text{ V}$, $I_C = 10\text{ mA}$	dB		1.9	
	$f = 2.0\text{ GHz}$			3.5	
	$f = 4.0\text{ GHz}$				
GA	Gain @ N_{F0} : $V_{CE} = 8\text{ V}$, $I_C = 10\text{ mA}$	dB		13.5	
	$f = 2.0\text{ GHz}$			9.5	
	$f = 4.0\text{ GHz}$				
f_T	Gain Bandwidth Product: $V_{CE} = 8\text{ V}$, $I_C = 35\text{ mA}$	GHz		8.0	
h_{FE}	Forward Current Transfer Ratio: $V_{CE} = 8\text{ V}$, $I_C = 35\text{ mA}$		30	150	300
ICBO	Collector Cutoff Current: $V_{CB} = 8\text{ V}$	μA			0.2
IEBO	Emitter Cutoff Current: $V_{EB} = 1\text{ V}$	μA			2.0
CCB	Collector Base Capacitance ¹ : $V_{CB} = 8\text{ V}$, $f = 1\text{ MHz}$	pF		0.32	

Note: 1. For this test the emitter is grounded.

AT-42085 Medium Power Silicon Bipolar Transistor

Absolute Maximum Ratings

Parameter	Symbol	Absolute Maximum
Emitter-Base Voltage	VEBO	1.5 V
Collector-Base Voltage	V _{CB0}	20 V
Collector-Emitter Voltage	V _{CE0}	12 V
Collector Current	I _C	80 mA
Power Dissipation ^{2,3}	P _T	500 mW
Junction Temperature	T _J	150°C
Storage Temperature	T _{STG}	-65°C to 150°C
Thermal Resistance ^{2,4} : $\theta_{jC} = 130^{\circ}\text{C/W}$		

Notes:

1. Operation of this device above any one of these parameters may cause permanent damage.
2. T_{CASE} = 25°C.
3. Derate at 7.7 mW/°C for T_C > 85°C.
4. See MEASUREMENTS section "Thermal Resistance" for more information.

Typical Performance, T_A = 25°C

(unless otherwise noted)

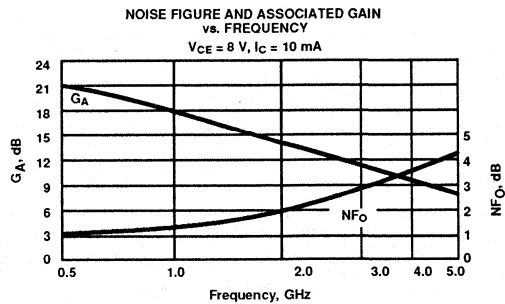
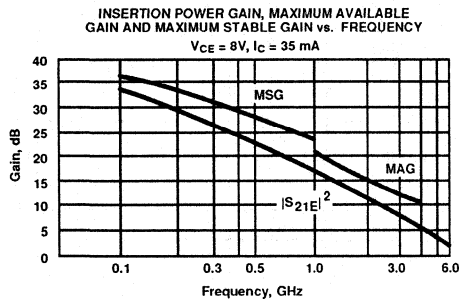
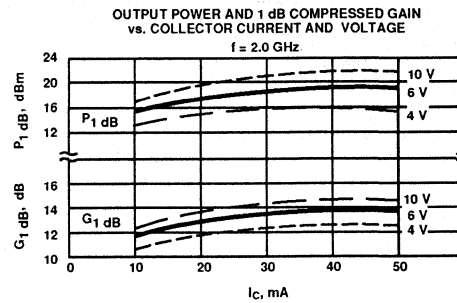
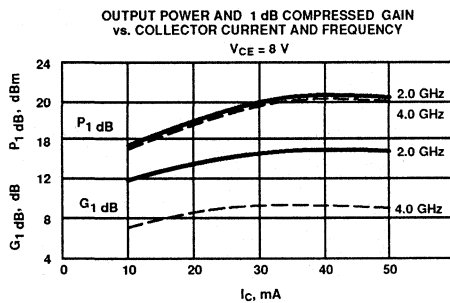
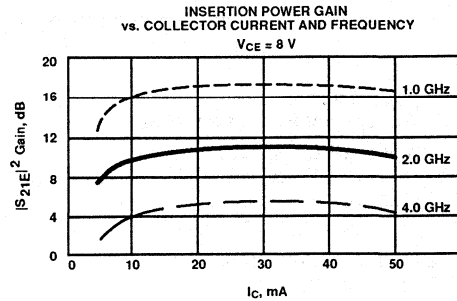

AT-42085
Medium Power Silicon Bipolar Transistor

Typical Scattering Parameters: Common Emitter, $Z_0 = 50 \Omega$

$T_A = 25^\circ\text{C}$, $V_{CE} = 8 \text{ V}$, $I_C = 10 \text{ mA}$

Freq. GHz	S ₁₁		S ₂₁			S ₁₂			S ₂₂	
	Mag	Ang	dB	Mag	Ang	dB	Mag	Ang	Mag	Ang
0.1	.72	-50	28.5	26.52	152	-37.0	.014	73	.90	-16
0.5	.66	-139	21.0	11.23	103	-29.2	.035	36	.53	-32
1.0	.65	-168	15.5	5.96	84	-28.6	.037	39	.45	-33
1.5	.65	175	12.2	4.06	71	-27.0	.045	46	.43	-36
2.0	.65	163	9.7	3.06	60	-25.3	.054	51	.42	-41
2.5	.66	157	8.0	2.51	55	-24.0	.063	60	.42	-42
3.0	.68	149	6.3	2.07	46	-22.8	.072	65	.41	-48
3.5	.68	141	5.1	1.79	38	-21.4	.085	64	.43	-55
4.0	.69	133	3.9	1.57	29	-19.7	.104	64	.45	-61
4.5	.69	125	3.0	1.41	21	-18.5	.119	63	.46	-66
5.0	.69	114	2.2	1.28	12	-17.1	.139	58	.47	-71
5.5	.71	103	1.4	1.17	3	-15.9	.161	55	.44	-76
6.0	.75	91	0.6	1.07	-6	-15.1	.177	49	.40	-85

$T_A = 25^\circ\text{C}$, $V_{CE} = 8 \text{ V}$, $I_C = 35 \text{ mA}$

0.1	.54	-90	33.1	45.38	137	-40.1	.010	66	.76	-26
0.5	.61	-163	22.6	13.45	95	-32.8	.023	52	.38	-30
1.0	.61	178	16.8	6.90	79	-29.5	.034	61	.34	-28
1.5	.62	167	13.4	4.67	68	-26.4	.048	68	.32	-31
2.0	.63	156	10.9	3.52	59	-23.9	.064	66	.31	-36
2.5	.64	152	9.2	2.89	54	-22.5	.075	68	.31	-40
3.0	.66	146	7.6	2.39	45	-21.2	.088	69	.30	-48
3.5	.67	139	6.3	2.07	37	-19.8	.102	67	.31	-58
4.0	.68	131	5.2	1.81	28	-18.6	.117	65	.33	-67
4.5	.68	123	4.2	1.62	19	-17.2	.138	60	.35	-73
5.0	.68	114	3.4	1.48	10	-16.4	.152	56	.35	-79
5.5	.71	103	2.5	1.34	1	-15.3	.171	50	.34	-85
6.0	.74	93	1.7	1.21	-8	-14.5	.188	46	.31	-96

A model for this device is available in the DEVICE MODELS section.

Features

- **High Output Power:**
20.5 dBm typical $P_{1\text{ dB}}$ at 2.0 GHz
- **High Gain at 1 dB Compression:**
13.5 dB typical $G_{1\text{ dB}}$ at 2.0 GHz
- **Low Noise Figure:**
1.9 dB typical NF_0 at 2.0 GHz
- **High Gain-Bandwidth Product:**
8.0 GHz typical f_T
- **Surface Mount Plastic Package**
- **Tape-and-Reel Packaging Option Available¹**

Description

Avantek's AT-42086 is a high performance NPN silicon bipolar transistor housed in a low cost, surface mount plastic package. This device is designed for use in medium power, wide band amplifier and oscillator applications operating over VHF, UHF and microwave frequencies.

Excellent device uniformity, performance and reliability are produced by the use of ion-implantation, self-alignment techniques, and gold metallization in the fabrication of these devices.

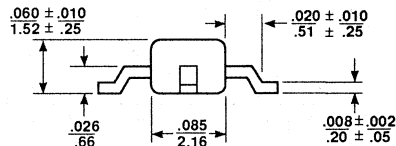
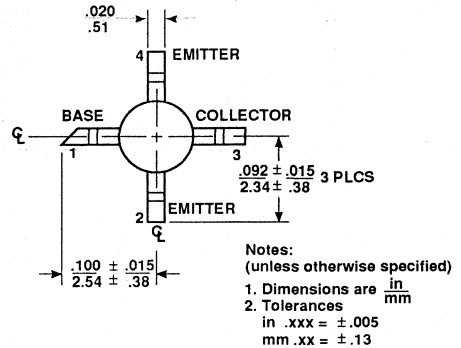
Avantek 86 Plastic Package

Noise Parameters: $V_{CE} = 8\text{ V}$, $I_C = 10\text{ mA}$

Freq. GHz	NF_0 dB	Gamma Mag	Opt Ang	$R_N/50$
0.1	1.0	.04	8	0.13
0.5	1.1	.03	62	0.12
1.0	1.5	.06	168	0.12
2.0	1.9	.25	-146	0.12
4.0	3.5	.58	-100	0.52

Electrical Specifications, $T_A = 25^\circ\text{C}$

Symbol	Parameters and Test Conditions	Units	Min.	Typ.	Max.	
$ S_{21E} ^2$	Insertion Power Gain: $V_{CE} = 8\text{ V}$, $I_C = 35\text{ mA}$	f = 1.0 GHz f = 2.0 GHz f = 4.0 GHz	dB	15.0	16.5 10.5 4.5	
$P_{1\text{ dB}}$	Power Output @ 1 dB Gain Compression: $V_{CE} = 8\text{ V}$, $I_C = 35\text{ mA}$	f = 2.0 GHz f = 4.0 GHz	dBm		20.5 20.0	
$G_{1\text{ dB}}$	1 dB Compressed Gain: $V_{CE} = 8\text{ V}$, $I_C = 35\text{ mA}$	f = 2.0 GHz f = 4.0 GHz	dB		13.5 9.0	
NF_0	Optimum Noise Figure: $V_{CE} = 8\text{ V}$, $I_C = 10\text{ mA}$	f = 2.0 GHz f = 4.0 GHz	dB		1.9 3.5	
G_A	Gain @ NF_0 : $V_{CE} = 8\text{ V}$, $I_C = 10\text{ mA}$	f = 2.0 GHz f = 4.0 GHz	dB		13.0 9.0	
f_T	Gain Bandwidth Product: $V_{CE} = 8\text{ V}$, $I_C = 35\text{ mA}$		GHz		8.0	
h_{FE}	Forward Current Transfer Ratio: $V_{CE} = 8\text{ V}$, $I_C = 35\text{ mA}$			30	150	300
I_{CBO}	Collector Cutoff Current: $V_{CB} = 8\text{ V}$		μA			0.2
I_{EBO}	Emitter Cutoff Current: $V_{EB} = 1\text{ V}$		μA			2.0
CCB	Collector Base Capacitance ² : $V_{CB} = 8\text{ V}$, f = 1 MHz		pF		0.32	

Notes: 1. Refer to PACKAGING section "Tape-and-Reel Packaging for Surface Mount Semiconductors".
2. For this test, the emitter is grounded.

Absolute Maximum Ratings

Parameter	Symbol	Absolute Maximum ¹
Emitter-Base Voltage	VEBO	1.5 V
Collector-Base Voltage	VCBO	20 V
Collector-Emitter Voltage	VCEO	12 V
Collector Current	IC	80 mA
Power Dissipation ^{2,3}	PT	500 mW
Junction Temperature	T _J	150°C
Storage Temperature	T _{STG}	-65°C to 150°C

Thermal Resistance^{2,4}: $\theta_{jC} = 140^{\circ}\text{C/W}$

Notes:

1. Operation of this device above any one of these parameters may cause permanent damage.
2. TCASE = 25°C.
3. Derate at 7.1 mW/°C for TC > 80°C.
4. See MEASUREMENTS section "Thermal Resistance" for more information.

Part Number Ordering Information

Part Number	Devices Per Reel	Reel Size
AT-42086-TR1	1000	7"
AT-42086-TR2	4000	13"

Typical Performance, T_A = 25°C
(unless otherwise noted)

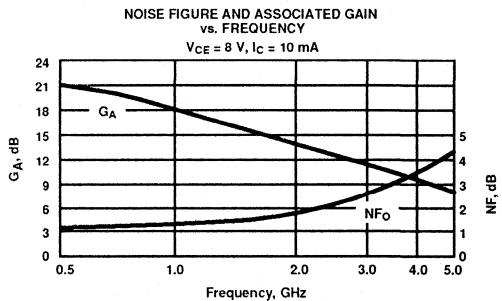
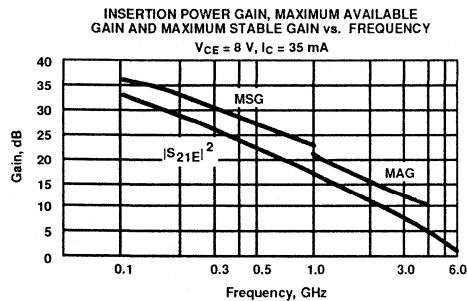
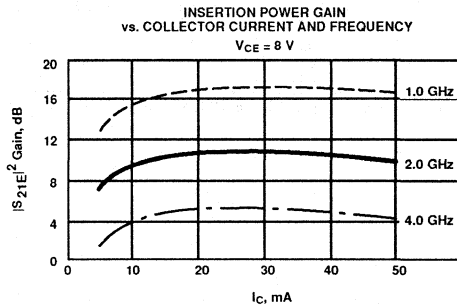
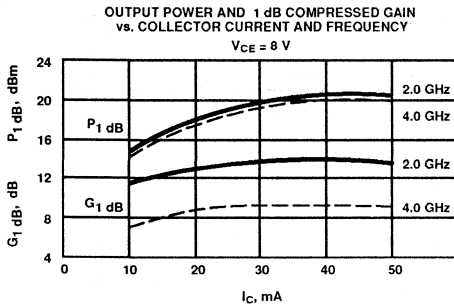

AT-42086
Medium Power Silicon Bipolar Transistor

Typical Scattering Parameters: Common Emitter, $Z_0 = 50 \Omega$

$T_A = 25^\circ\text{C}$, $V_{CE} = 8 \text{ V}$, $I_C = 10 \text{ mA}$

Freq. GHz	S_{11}		S_{21}			S_{12}			S_{22}	
	Mag	Ang	dB	Mag	Ang	dB	Mag	Ang	Mag	Ang
0.1	.68	-48	28.0	25.12	153	-36.0	.016	65	.91	-15
0.5	.63	-141	20.9	11.07	102	-29.9	.032	42	.54	-30
1.0	.63	-176	15.4	5.87	80	-27.4	.043	43	.43	-30
1.5	.65	164	12.0	3.98	65	-26.0	.050	46	.40	-34
2.0	.66	151	9.5	2.99	53	-23.9	.064	52	.38	-40
2.5	.69	142	7.8	2.44	45	-23.1	.070	53	.36	-46
3.0	.71	132	6.2	2.04	34	-21.6	.084	54	.34	-54
3.5	.73	123	4.8	1.74	24	-19.7	.104	53	.33	-67
4.0	.75	115	3.6	1.51	14	-18.3	.122	51	.30	-80
4.5	.78	108	2.6	1.34	5	-17.2	.138	50	.31	-94
5.0	.80	101	1.6	1.20	-4	-16.0	.159	46	.31	-110
5.5	.82	95	0.6	1.08	-12	-14.8	.182	40	.32	-129
6.0	.85	89	-0.2	0.97	-21	-14.0	.200	35	.34	-148

$T_A = 25^\circ\text{C}$, $V_{CE} = 8 \text{ V}$, $I_C = 35 \text{ mA}$

0.1	.48	-94	32.8	43.62	137	-37.7	.013	65	.77	-25
0.5	.57	-168	22.4	13.21	92	-32.6	.023	57	.39	-28
1.0	.59	168	16.5	6.69	75	-28.7	.037	62	.33	-27
1.5	.61	154	13.0	4.48	62	-24.8	.057	64	.31	-31
2.0	.63	143	10.5	3.36	51	-23.0	.071	61	.29	-37
2.5	.68	137	8.7	2.72	43	-21.0	.089	56	.26	-45
3.0	.68	127	7.0	2.25	33	-19.7	.104	58	.25	-53
3.5	.71	118	5.7	1.92	24	-18.4	.121	55	.24	-65
4.0	.73	111	4.5	1.69	14	-17.3	.136	49	.20	-80
4.5	.76	104	3.5	1.49	5	-15.9	.161	46	.21	-95
5.0	.78	98	2.4	1.32	-3	-15.2	.174	43	.21	-115
5.5	.81	91	1.6	1.20	-12	-14.3	.193	36	.22	-136
6.0	.84	85	0.7	1.08	-20	-13.4	.213	31	.25	-156

A model for this device is available in the DEVICE MODELS section.

Features

- **Low Bias Current Operation**
- **Low Noise Figure: 1.9 dB typical at 2.0 GHz**
3.0 dB typical at 4.0 GHz
- **High Associated Gain: 8.0 dB typical at 2.0 GHz**
5.0 dB typical at 4.0 GHz
- **High Gain-Bandwidth Product: 9.0 GHz typical fr**

Description

Avantek's AT-60100 is a high performance NPN silicon bipolar transistor chip designed for use in low noise, wide band amplifier and oscillator applications operating over VHF, UHF and microwave frequencies.

The die are nitride-passivated for surface protection. Excellent device uniformity, performance and reliability are produced by the use of ion-implantation, self alignment techniques, and gold metallization in the fabrication of these devices.

The recommended assembly procedure is gold-eutectic die attach at 400°C and either wedge or ball bonding using 0.7 mil gold wire. See also "Chip Use" in the APPLICATIONS section.

Avantek Chip Outline¹

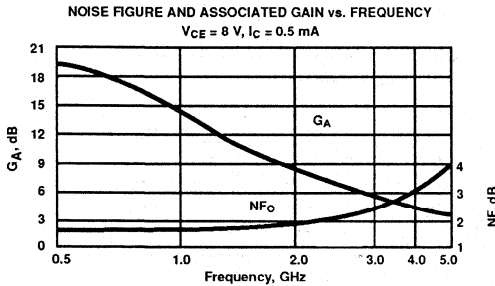
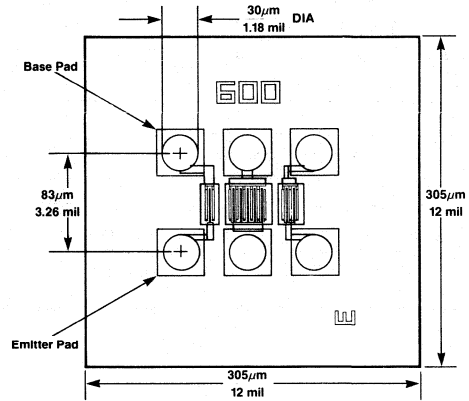

Electrical Specifications, $T_A = 25^\circ\text{C}$

Symbol	Parameters and Test Conditions ^{1,2}	Units	Min.	Typ.	Max.
NF ₀	Optimum Noise Figure: $V_{CE} = 8\text{ V}, I_C = 0.5\text{ mA}$	dB		1.6 1.9 3.0	
GA	Gain @ NF ₀ : $V_{CE} = 8\text{ V}, I_C = 0.5\text{ mA}$	dB		14.5 8.0 5.0	
$ S_{21E} ^2$	Insertion Power Gain: $V_{CE} = 8\text{ V}, I_C = 3\text{ mA}$	dB		9.0 4.0	
P ₁ dB	Power Output @ 1 dB Gain Compression: $V_{CE} = 8\text{ V}, I_C = 3\text{ mA}$	dBm		4.0	
G ₁ dB	1 dB Compressed Gain: $V_{CE} = 8\text{ V}, I_C = 3\text{ mA}$	dB		12.0	
f _T	Gain Bandwidth Product: $V_{CE} = 8\text{ V}, I_C = 3\text{ mA}$	GHz		9.0	
hFE	Forward Current Transfer Ratio: $V_{CE} = 8\text{ V}, I_C = 3\text{ mA}$		30	150	300
I _{CBO}	Collector Cutoff Current: $V_{CB} = 8\text{ V}$	µA			0.2
I _{EBO}	Emitter Cutoff Current: $V_{EB} = 1\text{ V}$	µA			1.0
CCB	Collector Base Capacitance ³ : $V_{CB} = 8\text{ V}, f = 1\text{ MHz}$	pF		0.07	

Notes: 1. This chip contains 3 active devices. The performance specified applies only to the device whose base and emitter pads are indicated on the chip outline.
 2. RF performance is determined by packaging and testing 10 devices per wafer.
 3. For this test, the emitter is grounded.

AT-60100

Low Noise Silicon Bipolar Transistor

Absolute Maximum Ratings

Parameter	Symbol	Absolute Maximum ¹
Emitter-Base Voltage	V_{EBO}	1.5 V
Collector-Base Voltage	V_{CBO}	20 V
Collector-Emitter Voltage	V_{CEO}	12 V
Collector Current	I_C	8 mA
Power Dissipation ^{2,3}	P_T	80 mW
Junction Temperature	T_j	200°C
Storage Temperature	T_{STG}	-65°C to 200°C

Thermal Resistance^{2,4}: $\theta_{jC} = 190^\circ\text{C/W}$

Notes:

1. Operation of this device above any one of these parameters may cause permanent damage.
2. $T_{MOUNTING SURFACE} = 25^\circ\text{C}$.
3. Derate at 5.3 mW/°C for $T_{MOUNTING SURFACE} > 185^\circ\text{C}$.
4. The small spot size of this technique results in a higher, though more accurate determination of θ_{jC} than do alternate methods. See MEASUREMENTS section "Thermal Resistance" for more information.

Part Number Ordering Information

Part Number	Devices Per Tray
AT-60100-GP2	10
AT-60100-GP4	100
AT-60100-GP6	up to 300

Typical Performance, $T_A = 25^\circ\text{C}$

(unless otherwise noted)

OPTIMUM NOISE FIGURE AND ASSOCIATED GAIN

vs. COLLECTOR CURRENT AND FREQUENCY

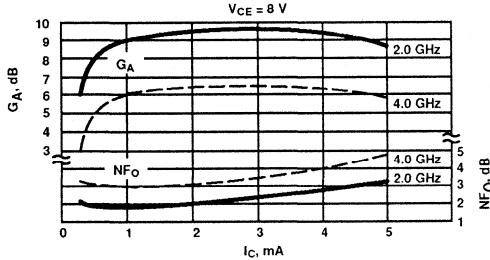

OUTPUT POWER AND 1 dB COMPRESSED GAIN

vs. COLLECTOR CURRENT

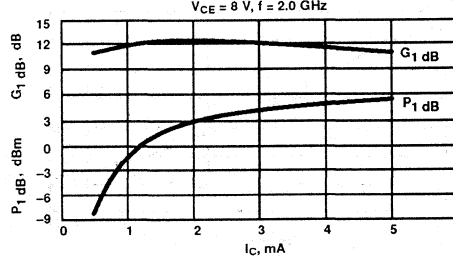

INSERTION POWER GAIN, MAXIMUM AVAILABLE GAIN AND MAXIMUM STABLE GAIN vs. FREQUENCY

$V_{CE} = 8 \text{ V}, I_C = 3 \text{ mA}$

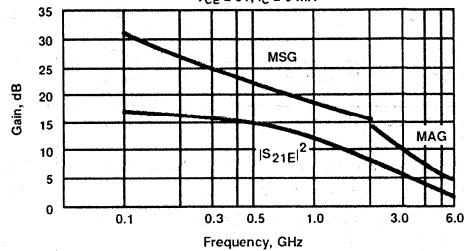

AT-60100
Low Noise Silicon Bipolar Transistor

Typical Scattering Parameters: Common Emitter, $Z_0 = 50 \Omega$

$T_A = 25^\circ\text{C}$, $V_{CE} = 8 \text{ V}$, $I_C = 0.5 \text{ mA}$

Freq. GHz	S_{11}		S_{21}			S_{12}			S_{22}	
	Mag	Ang	dB	Mag	Ang	dB	Mag	Ang	Mag	Ang
0.1	.99	2	4.2	1.63	-179	-43.1	.007	88	.99	-7
0.5	.98	-9	3.5	1.49	165	-29.9	.032	86	.99	-5
1.0	.92	-17	1.7	1.22	148	-24.4	.060	78	.99	-6
1.5	.90	-30	1.1	1.14	134	-21.2	.087	70	.96	-9
2.0	.76	-37	1.4	1.18	122	-19.6	.105	67	.92	-13
2.5	.70	-38	0.7	1.08	113	-18.2	.123	66	.91	-15
3.0	.61	-46	0.4	1.05	102	-17.1	.139	63	.88	-17
3.5	.52	-49	-0.5	0.95	94	-16.8	.145	61	.86	-20
4.0	.50	-60	-1.1	0.88	87	-16.4	.151	62	.86	-21
5.0	.50	-45	-2.2	0.78	80	-13.9	.202	62	.85	-26

$T_A = 25^\circ\text{C}$, $V_{CE} = 8 \text{ V}$, $I_C = 3 \text{ mA}$

0.1	.98	-2	17.4	7.43	176	-44.4	.006	83	.95	-7
0.5	.83	-26	15.3	5.81	145	-31.0	.028	78	.95	-9
1.0	.63	-44	12.5	4.23	124	-26.4	.048	70	.89	-10
1.5	.47	-57	10.6	3.38	114	-24.3	.061	68	.84	-11
2.0	.35	-61	8.9	2.77	98	-22.6	.074	67	.81	-13
2.5	.29	-61	7.4	2.33	91	-21.0	.089	69	.79	-14
3.0	.21	-68	6.2	2.03	83	-19.9	.101	69	.78	-15
3.5	.18	-68	4.9	1.76	79	-19.1	.111	70	.77	-18
4.0	.14	-80	4.0	1.59	75	-18.3	.122	73	.78	-19
5.0	.10	-63	2.4	1.31	67	-16.5	.150	71	.78	-25

A model for this device is available in the DEVICE MODELS section.

Features

- Low Bias Current Operation
- Low Noise Figure: 1.9 dB typical at 2.0 GHz
3.0 dB typical at 4.0 GHz
- High Associated Gain: 10.0 dB typical at 2.0 GHz
6.5 dB typical at 4.0 GHz
- High Gain-Bandwidth Product: 9.0 GHz typical fr

Description

Avantek's AT-60200 is a high performance NPN silicon bipolar transistor chip designed for use in low noise, wide band amplifier and oscillator applications operating over VHF, UHF and microwave frequencies.

The die are nitride-passivated for surface protection. Excellent device uniformity, performance and reliability are produced by the use of ion-implantation, self alignment techniques, and gold metallization in the fabrication of these devices.

The recommended assembly procedure is gold-eutectic die attach at 400°C and either wedge or ball bonding using 0.7 mil gold wire. See also "Chip Use" in the APPLICATIONS section.

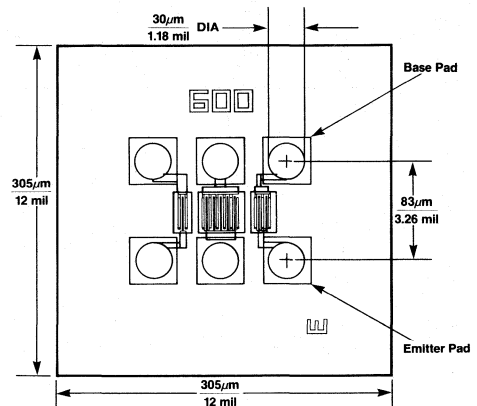
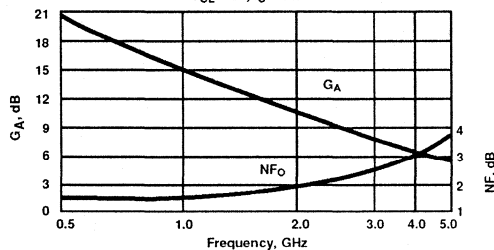
Avantek Chip Outline¹

NOISE FIGURE AND ASSOCIATED GAIN vs. FREQUENCY
 $V_{CE} = 8V, I_C = 1mA$

Electrical Specifications, $T_A = 25^\circ C$

Symbol	Parameter and Test Conditions ^{1,2}	Units	Min.	Typ.	Max.
NFO	Optimum Noise Figure: $V_{CE} = 8V, I_C = 1mA$				
	$f = 1.0 GHz$	dB		1.4	
	$f = 2.0 GHz$			1.9	
	$f = 4.0 GHz$			3.0	
GA	Gain @ NFO: $V_{CE} = 8V, I_C = 1mA$				
	$f = 1.0 GHz$	dB		15.0	
	$f = 2.0 GHz$			10.0	
	$f = 4.0 GHz$			6.5	
$ S_{21E} ^2$	Insertion Power Gain: $V_{CE} = 8V, I_C = 5mA$				
	$f = 2.0 GHz$	dB		11.0	
	$f = 4.0 GHz$			5.5	
P_1 dB	Power Output @ 1 dB Gain Compression: $V_{CE} = 8V, I_C = 5mA$				
	$f = 2.0 GHz$	dBm		6.5	
G_1 dB	1 dB Compressed Gain: $V_{CE} = 8V, I_C = 5mA$				
	$f = 2.0 GHz$	dB		13.5	
fr	Gain Bandwidth Product: $V_{CE} = 8V, I_C = 5mA$				
		GHz		9.0	
hFE	Forward Current Transfer Ratio: $V_{CE} = 8V, I_C = 5mA$		30	150	300
ICBO	Collector Cutoff Current: $V_{CB} = 8V$	μA			0.2
IEBO	Emitter Cutoff Current: $V_{EB} = 1V$	μA			1.0
CCB	Collector Base Capacitance ³ : $V_{CB} = 8V, f = 1MHz$	pF		0.08	

Notes: 1. This chip contains 3 active devices. The performance specified applies only to the device whose base and emitter pads are indicated on the chip outline.
 2. RF performance is determined by packaging and testing 10 devices per wafer.
 3. For this test, the emitter is grounded.

Absolute Maximum Ratings

Parameter	Symbol	Absolute Maximum ¹
Emitter-Base Voltage	VEBO	1.5 V
Collector-Base Voltage	VCBO	20 V
Collector-Emitter Voltage	VCEO	12 V
Collector Current	IC	16 mA
Power Dissipation ^{2,3}	PT	160 mW
Junction Temperature	Tj	200°C
Storage Temperature	TSTG	-65°C to 200°C

Thermal Resistance^{2,4}: $\theta_{jC} = 155^\circ\text{C/W}$

Notes:

1. Operation of this device above any one of these parameters may cause permanent damage.
2. T_{MOUNTING SURFACE} = 25°C.
3. Derate at 6.5 mW/°C for T_{MOUNTING SURFACE} > 175°C.
4. The small spot size of this technique results in a higher, though more accurate determination of θ_{jC} than do alternate methods. See MEASUREMENTS section "Thermal Resistance" for more information.

Part Number Ordering Information

Part Number	Devices Per Tray
AT-60200-GP2	10
AT-60200-GP4	100
AT-60200-GP6	up to 300

Typical Performance, T_A = 25°C

(unless otherwise noted)

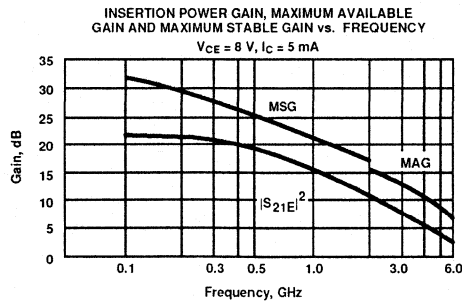
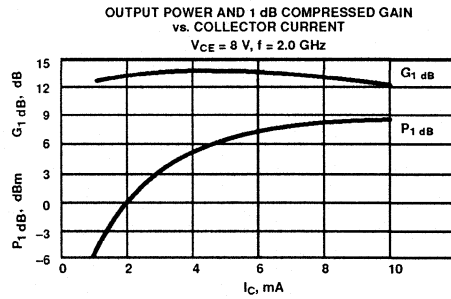
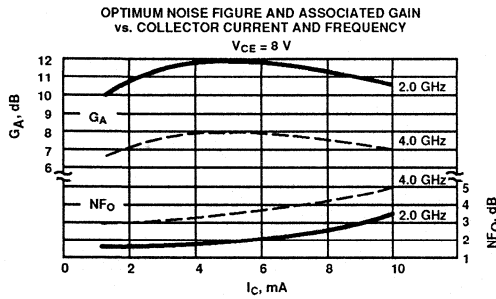

AT-60200
Low Noise Silicon Bipolar Transistor

Typical Scattering Parameters: Common Emitter, $Z_O = 50 \Omega$

$T_A = 25^\circ\text{C}$, $V_{CE} = 8 \text{ V}$, $I_C = 1 \text{ mA}$

Freq. GHz	S_{11}		S_{21}			S_{12}			S_{22}	
	Mag	Ang	dB	Mag	Ang	dB	Mag	Ang	Mag	Ang
0.1	.97	-8	16.9	7.00	172	-43.1	.007	87	.99	-3
0.5	.85	-32	15.8	6.13	147	-29.9	.032	73	.94	-11
1.0	.66	-57	13.6	4.78	126	-25.2	.055	64	.87	-13
1.5	.52	-74	11.7	3.86	108	-23.4	.068	59	.79	-14
2.0	.41	-89	9.9	3.12	99	-22.2	.078	58	.75	-17
2.5	.34	-101	8.7	2.71	90	-20.8	.091	59	.74	-17
3.0	.29	-114	7.3	2.31	82	-20.0	.100	61	.72	-18
3.5	.25	-126	6.2	2.03	74	-19.3	.108	60	.71	-20
4.0	.23	-137	5.3	1.83	69	-18.4	.120	61	.71	-23
5.0	.20	-163	3.4	1.47	57	-17.5	.133	61	.72	-26

$T_A = 25^\circ\text{C}$, $V_{CE} = 8 \text{ V}$, $I_C = 5 \text{ mA}$

0.1	.87	-8	22.0	12.51	169	-50.5	.003	88	.92	-6
0.5	.70	-44	19.0	8.94	138	-31.4	.027	72	.90	-12
1.0	.48	-74	15.7	6.12	113	-27.7	.041	65	.81	-11
1.5	.32	-97	13.1	4.54	100	-26.0	.050	66	.76	-11
2.0	.24	-114	10.9	3.50	90	-24.4	.060	67	.73	-13
2.5	.19	-134	9.3	2.90	83	-23.0	.071	71	.73	-14
3.0	.15	-161	7.7	2.42	76	-21.7	.082	74	.73	-15
3.5	.11	-160	6.4	2.08	74	-20.5	.095	75	.73	-18
4.0	.15	178	5.4	1.87	70	-19.5	.106	80	.73	-18
5.0	.14	168	4.0	1.59	61	-17.4	.135	74	.72	-24

A model for this device is available in the DEVICE MODELS section.

Features

- **Low Bias Current Operation**
- **Low Noise Figure: 1.8 dB typical at 2.0 GHz**
2.8 dB typical at 4.0 GHz
- **High Associated Gain: 12.5 dB typical at 2.0 GHz**
8.0 dB typical at 4.0 GHz
- **High Gain-Bandwidth Product: 9.0 GHz typical f_T**

Description

Avantek's AT-60500 is a high performance NPN silicon bipolar transistor chip designed for use low noise, wide band amplifier and oscillator applications operating over VHF, UHF and micro-wave frequencies.

The die are nitride-passivated for surface protection. Excellent device uniformity, performance and reliability are produced by the use of ion-implanation, self-alignment techniques, and gold metallization in the fabrication of these devices.

The recommended assembly procedure is gold-eutectic die attach at 400°C and either wedge or ball bonding using 0.7 mil gold wire. See also "Chip Use" in the APPLICATIONS section.

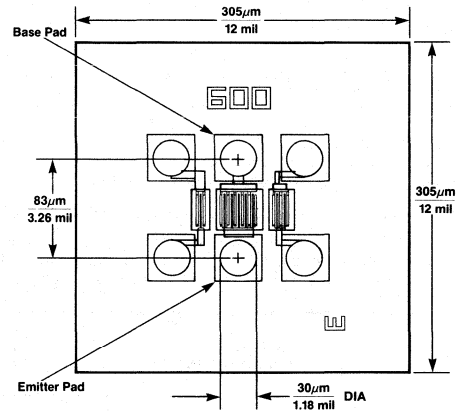
Avantek Chip Outline¹

NOISE FIGURE AND ASSOCIATED GAIN vs. FREQUENCY
 $V_{CE} = 8\text{ V}, I_C = 2\text{ mA}$

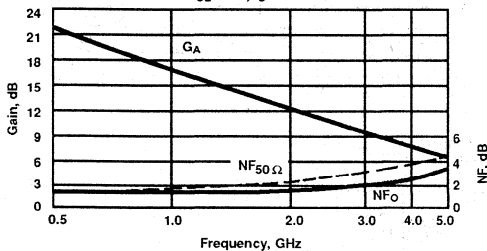

Noise Parameters: $V_{CE} = 8\text{ V}, I_C = 2\text{ mA}$

Freq. GHz	NF ₀ dB	Gamma Opt Mag	Ang	R _N /50
1.0	1.4	.58	44	0.20
2.0	1.8	.48	90	0.24
4.0	2.8	.50	155	0.20

Electrical Specifications, $T_A = 25^\circ\text{C}$

Symbol	Parameters and Test Conditions ^{1,2}	Units	Min.	Typ.	Max.
NF ₀	Optimum Noise Figure: $V_{CE} = 8\text{ V}, I_C = 2\text{ mA}$				
	$f = 1.0\text{ GHz}$	dB		1.4	
	$f = 2.0\text{ GHz}$			1.8	
	$f = 4.0\text{ GHz}$			2.8	
GA	Gain @ NF ₀ : $V_{CE} = 8\text{ V}, I_C = 2\text{ mA}$	dB		16.5	
	$f = 1.0\text{ GHz}$			12.5	
	$f = 2.0\text{ GHz}$			8.0	
	$f = 4.0\text{ GHz}$				
S _{21E} ²	Insertion Power Gain: $V_{CE} = 8\text{ V}, I_C = 10\text{ mA}$	dB		12.0	
	$f = 2.0\text{ GHz}$			6.5	
	$f = 4.0\text{ GHz}$				
P ₁ dB	Power Output @ 1 dB Gain Compression: $V_{CE} = 8\text{ V}, I_C = 10\text{ mA}$	dBm		16.0	
	1 dB Compressed Gain: $V_{CE} = 8\text{ V}, I_C = 10\text{ mA}$	dB		12.5	
	$f = 2.0\text{ GHz}$				
f_T	Gain Bandwidth Product: $V_{CE} = 8\text{ V}, I_C = 10\text{ mA}$	GHz		9.0	
h _{FE}	Forward Current Transfer Ratio: $V_{CE} = 8\text{ V}, I_C = 10\text{ mA}$		30	150	300
I _{CBO}	Collector Cutoff Current: $V_{CB} = 8\text{ V}$	µA			0.2
I _{EBO}	Emitter Cutoff Current: $V_{EB} = 1\text{ V}$	µA			1.0
CCB	Collector Base Capacitance ³ : $V_{CB} = 8\text{ V}, f = 1\text{ MHz}$	pF		0.11	

Notes: 1. This chip contains 3 active devices. The performance specified applies only to the device whose base and emitter pads are indicated on the chip outline.
 2. RF performance is determined by packaging and testing 10 devices per wafer.
 3. For this test, the emitter is grounded.

AT-60500

Low Noise Silicon Bipolar Transistor

Absolute Maximum Ratings

Parameter	Symbol	Absolute Maximum
Emitter-Base Voltage	VEBO	1.5 V
Collector-Base Voltage	VCBO	20 V
Collector-Emitter Voltage	VCEO	12 V
Collector Current	IC	40 mA
Power Dissipation ^{2,3}	PT	400 mW
Junction Temperature	Tj	200°C
Storage Temperature	TSTG	-65°C to 200°C

Thermal Resistance^{2,4}: $\theta_{jc} = 120^\circ\text{C}/\text{W}$

Notes:

1. Operation of this device above any one of these parameters may cause permanent damage.
2. TMOUNTING SURFACE = 25°C.
3. Derate at 8.3 mW/°C for TMOUNTING SURFACE > 152°C.
4. The small spot size of this technique results in a higher, though more accurate determination of θ_{jc} than do alternate methods. See MEASUREMENTS section "Thermal Resistance" for more information.

Part Number Ordering Information

Part Number	Devices Per Tray
AT-60500-GP2	10
AT-60600-GP4	100
AT-60500-GP6	up to 300

Typical Performance, $T_A = 25^\circ\text{C}$

(unless otherwise noted)

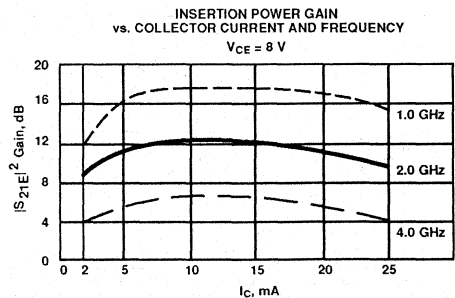
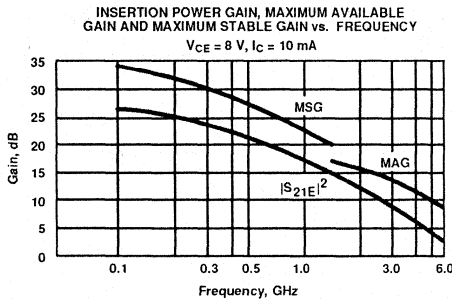
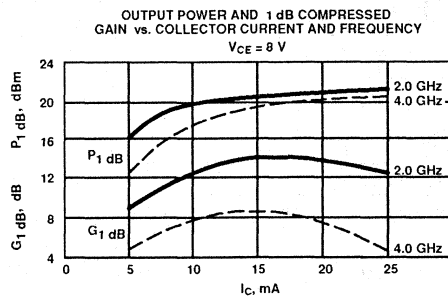
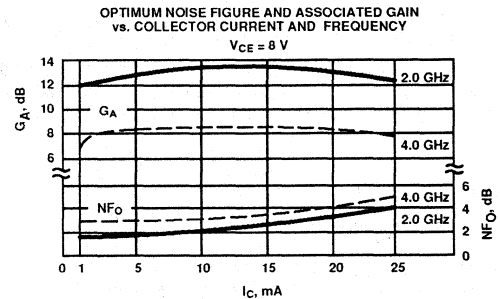
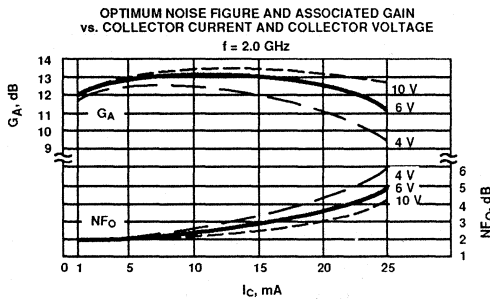

AT-60500
Low Noise Silicon Bipolar Transistor

Typical Scattering Parameters: Common Emitter, $Z_0 = 50 \Omega$

$T_A = 25^\circ\text{C}$, $V_{CE} = 8 \text{ V}$, $I_C = 2 \text{ mA}$

Freq. GHz	S_{11}		S_{21}			S_{12}			S_{22}	
	Mag	Ang	dB	Mag	Ang	dB	Mag	Ang	Mag	Ang
0.1	.97	-6	16.7	6.86	176	-40.0	.010	85	.92	-7
0.5	.88	-34	14.3	5.17	149	-27.3	.043	71	.95	-13
1.0	.74	-72	12.0	4.00	127	-23.3	.068	55	.84	-16
1.5	.60	-101	10.2	3.22	112	-22.6	.074	48	.76	-19
2.0	.57	-123	9.0	2.83	97	-21.6	.083	43	.71	-22
2.5	.53	-140	7.7	2.43	88	-21.4	.085	45	.69	-23
3.0	.49	-158	6.5	2.11	79	-21.4	.085	50	.67	-24
3.5	.50	-167	5.3	1.85	73	-21.0	.089	51	.66	-26
4.0	.50	-176	4.2	1.63	68	-20.6	.093	56	.66	-28
4.5	.50	174	3.1	1.43	61	-20.5	.095	58	.67	-30
5.0	.50	166	2.3	1.30	56	-20.0	.100	64	.68	-32
5.5	.52	158	1.7	1.22	50	-19.4	.107	67	.67	-36
6.0	.50	148	0.8	1.10	45	-18.9	.114	70	.69	-39

$T_A = 25^\circ\text{C}$, $V_{CE} = 8 \text{ V}$, $I_C = 10 \text{ mA}$

0.1	.68	-21	26.9	22.02	166	-40.9	.009	80	.95	-7
0.5	.55	-93	22.5	13.27	123	-31.7	.026	60	.74	-20
1.0	.46	-137	17.8	7.73	101	-28.9	.036	58	.63	-17
1.5	.44	-160	14.7	5.41	90	-27.1	.044	65	.58	-16
2.0	.44	-173	12.2	4.05	82	-25.5	.053	68	.57	-17
2.5	.45	178	10.5	3.36	77	-23.9	.064	72	.57	-18
3.0	.45	169	9.1	2.84	71	-22.5	.075	76	.56	-20
3.5	.46	163	7.8	2.45	66	-21.4	.085	78	.56	-22
4.0	.46	157	6.7	2.16	63	-20.4	.096	81	.57	-24
4.5	.47	150	5.5	1.88	56	-19.5	.106	80	.58	-27
5.0	.47	144	4.7	1.72	53	-18.6	.117	83	.59	-28
5.5	.50	140	4.0	1.58	48	-17.8	.129	83	.59	-32
6.0	.49	132	3.1	1.43	43	-17.1	.139	82	.61	-36

A model for this device is available in the DEVICE MODELS section.

Features

- Low Bias Current Operation:
- Low Noise Figure: 1.8 dB typical at 2.0 GHz
2.8 dB typical at 4.0 GHz
- High Associated Gain: 12.0 dB typical at 2.0 GHz
7.5 dB typical at 4.0 GHz
- High Gain-Bandwidth Product: 8.0 GHz typical f_T
- Hermetic Gold-ceramic Microstrip Package

Description

Avantek's AT-60510 is a high performance NPN silicon bipolar transistor housed in a hermetic, high reliability package. This device is designed for use in low noise, wide band amplifier and oscillator applications operating over VHF, UHF and microwave frequencies.

Excellent device uniformity, performance and reliability are produced by the use of ion-implantation, self-alignment techniques, and gold metallization in the fabrication of these devices.

Avantek 100 mil Package

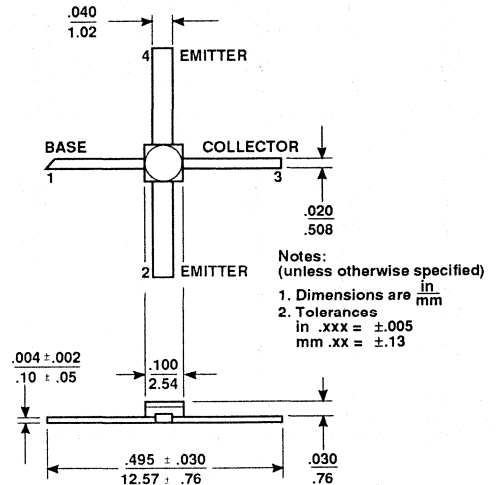

NOISE FIGURE AND ASSOCIATED GAIN vs. FREQUENCY
 $V_{CE} = 8\text{ V}, I_C = 2\text{ mA}$

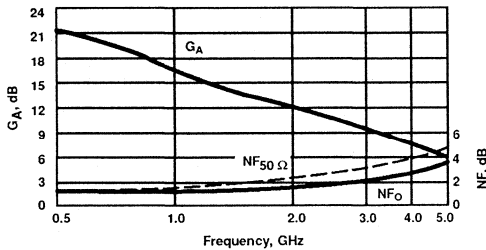

Noise Parameters: $V_{CE} = 8\text{ V}, I_C = 2\text{ mA}$

Freq. GHz	NF_0 dB	Gamma Mag	Opt Ang	$R_N/50$
1.0	1.4	.50	50	0.32
2.0	1.8	.44	97	0.42
4.0	2.8	.38	-163	0.42

Electrical Specifications, $T_A = 25^\circ\text{C}$

Symbol	Parameters and Test Conditions	Units	Min.	Typ.	Max.
NF_0	Optimum Noise Figure: $V_{CE} = 8\text{ V}, I_C = 2\text{ mA}$			1.4	2.1
G_A	Gain @ NF_0 : $V_{CE} = 8\text{ V}, I_C = 2\text{ mA}$			1.8 2.8	
$ S_{21E} ^2$	Insertion Power Gain: $V_{CE} = 8\text{ V}, I_C = 10\text{ mA}$			12.0 6.5	
P_1 dB	Power Output @ 1 dB Gain Compression: $V_{CE} = 8\text{ V}, I_C = 10\text{ mA}$			16.0	
G_1 dB	1 dB Compressed Gain: $V_{CE} = 8\text{ V}, I_C = 10\text{ mA}$			11.5	
f_T	Gain Bandwidth Product: $V_{CE} = 8\text{ V}, I_C = 10\text{ mA}$			8.0	
hFE	Forward Current Transfer Ratio: $V_{CE} = 8\text{ V}, I_C = 10\text{ mA}$		30	150	300
I_{CBO}	Collector Cutoff Current: $V_{CB} = 8\text{ V}$	μA			0.2
I_{EBO}	Emitter Cutoff Current: $V_{EB} = 1\text{ V}$	μA			1.0
CCB	Collector Base Capacitance: $V_{CB} = 8\text{ V}, f = 1\text{ MHz}$	pF		0.15	

Note: 1. For this test the emitter is grounded.

Absolute Maximum Ratings

Parameter	Symbol	Absolute Maximum ¹
Emitter-Base Voltage	VEBO	1.5 V
Collector-Base Voltage	V _{CBO}	20 V
Collector-Emitter Voltage	V _{CEO}	12 V
Collector Current	I _C	40 mA
Power Dissipation ^{2,3}	P _T	400 mW
Junction Temperature	T _j	200°C
Storage Temperature	T _{STG}	-65°C to 200°C

Thermal Resistance^{2,4}: $\theta_{jc} = 200^\circ\text{C/W}$

Notes:

1. Operation of this device above any one of these parameters may cause permanent damage.
2. TCASE = 25°C.
3. Derate at 5 mW/°C for T_C > 120°C.
4. The small spot size of this technique results in a higher, though more accurate determination of θ_{jc} than do alternate methods. See MEASUREMENTS section "Thermal Resistance" for more information.

Typical Performance, T_A = 25°C

(unless otherwise noted)

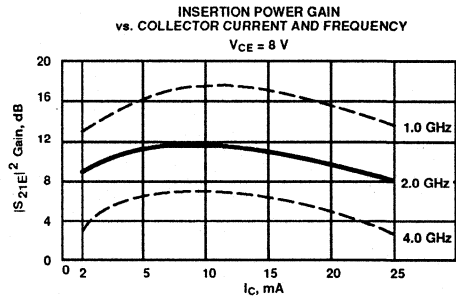
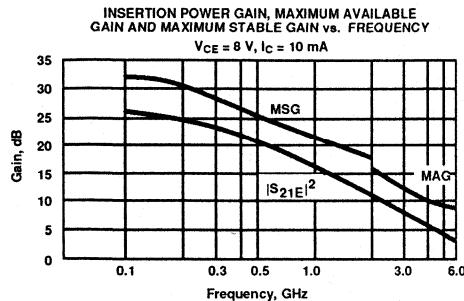
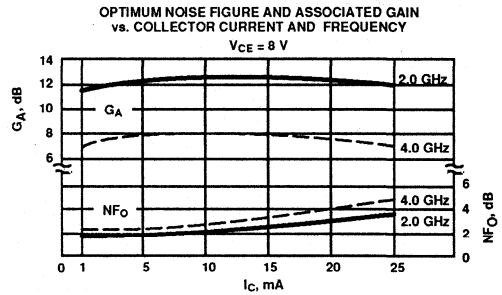
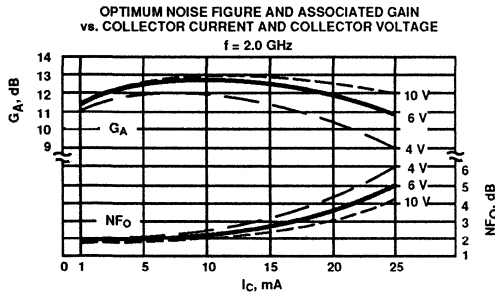
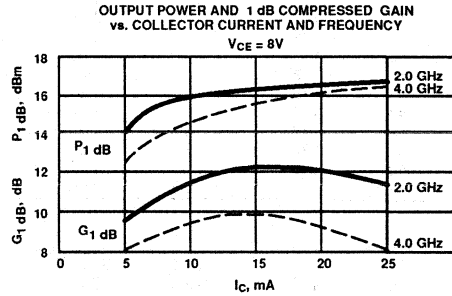

AT-60510
Low Noise Silicon Bipolar Transistor

Typical Scattering Parameters: Common Emitter, $Z_0 = 50 \Omega$

$T_A = 25^\circ\text{C}$, $V_{CE} = 8 \text{ V}$, $I_C = 2 \text{ mA}$

Freq. GHz	S_{11}		S_{21}			S_{12}		S_{22}		
	Mag	Ang	dB	Mag	Ang	dB	Mag	Ang	Mag	Ang
0.1	.95	-10	15.9	6.25	171	-39.2	.011	91	.99	-4
0.5	.86	-47	14.8	5.46	141	-26.8	.046	61	.92	-19
1.0	.71	-82	12.4	4.16	112	-23.0	.071	43	.83	-31
1.5	.59	-108	10.3	3.26	92	-21.8	.082	33	.76	-38
2.0	.52	-131	8.4	2.63	76	-21.2	.088	26	.72	-44
2.5	.48	-146	7.0	2.25	66	-20.4	.095	27	.70	-45
3.0	.45	-162	5.8	1.94	54	-21.0	.089	24	.68	-50
3.5	.45	-178	4.6	1.71	42	-20.4	.096	21	.69	-56
4.0	.43	167	3.6	1.52	31	-20.0	.100	22	.70	-63
4.5	.42	152	2.8	1.38	20	-19.6	.105	20	.70	-68
5.0	.41	134	2.0	1.26	9	-19.1	.111	18	.70	-73
5.5	.43	116	1.4	1.17	0	-18.5	.119	16	.70	-77
6.0	.48	101	0.7	1.09	-10	-18.2	.123	16	.67	-83

$T_A = 25^\circ\text{C}$, $V_{CE} = 8 \text{ V}$, $I_C = 10 \text{ mA}$

0.1	.71	-26	26.6	21.30	162	-39.2	.011	75	.96	-9
0.5	.55	-100	22.1	12.77	116	-30.8	.029	50	.71	-27
1.0	.46	-141	17.3	7.36	90	-27.6	.042	43	.59	-31
1.5	.43	-165	14.1	5.11	76	-25.6	.052	48	.57	-35
2.0	.42	178	11.8	3.91	64	-24.2	.061	45	.55	-40
2.5	.43	168	10.1	3.21	57	-23.4	.068	54	.54	-41
3.0	.43	157	8.7	2.72	48	-21.8	.081	53	.54	-47
3.5	.44	145	7.5	2.37	37	-20.8	.092	50	.55	-55
4.0	.44	134	6.4	2.10	27	-19.8	.102	45	.56	-62
4.5	.43	121	5.5	1.88	17	-18.9	.114	42	.58	-69
5.0	.44	106	4.6	1.71	7	-18.2	.123	38	.59	-76
5.5	.47	92	3.8	1.56	-1	-17.5	.134	33	.59	-81
6.0	.52	81	3.1	1.42	-11	-16.8	.145	29	.57	-88

A model for this device is available in the DEVICE MODELS section.

Features

- **Low Bias Current Operation:**
- **Low Noise Figure:** 1.8 dB typical at 2.0 GHz
2.8 dB typical at 4.0 GHz
- **High Associated Gain:** 12.0 dB typical at 2.0 GHz
7.5 dB typical at 4.0 GHz
- **High Gain-Bandwidth Product:** 8.0 GHz typical f_T
- **Cost Effective Ceramic Microstrip Package**

Description

Avantek's AT-60535 is a high performance NPN silicon bipolar transistor housed in a cost-effective, microstrip package. This device is designed for use in low noise, wide band amplifier and oscillator applications operating over VHF, UHF and microwave frequencies.

Excellent device uniformity, performance and reliability are produced by the use of ion-implantation, self-alignment techniques, and gold metallization in the fabrication of these devices.

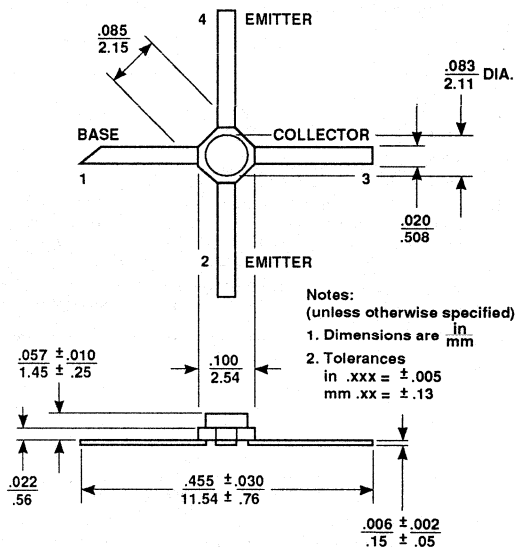
Avantek 35 micro-X Package

NOISE FIGURE AND ASSOCIATED GAIN
 vs. FREQUENCY
 $V_{CE} = 8\text{ V}, I_C = 2\text{ mA}$

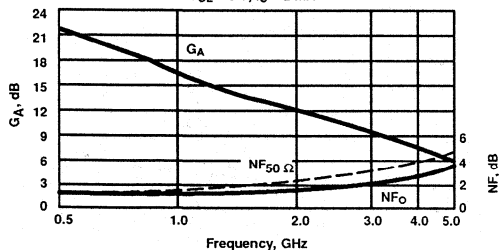

Noise Parameters: $V_{CE} = 8\text{ V}, I_C = 2\text{ mA}$

Freq. GHz	NF ₀ dB	Gamma Opt Mag	Gamma Opt Ang	R _N /50
1.0	1.4	.50	55	0.32
2.0	1.8	.40	114	0.38
4.0	2.8	.38	-153	0.40

Electrical Specifications, $T_A = 25^\circ\text{C}$

Symbol	Parameters and Test Conditions	Units	Min.	Typ.	Max.
NF ₀	Optimum Noise Figure: $V_{CE} = 8\text{ V}, I_C = 2\text{ mA}$				
		$f = 1.0\text{ GHz}$		1.4	
		$f = 2.0\text{ GHz}$		1.8	2.1
		$f = 4.0\text{ GHz}$		2.8	
GA	Gain @ NF ₀ : $V_{CE} = 8\text{ V}, I_C = 2\text{ mA}$				
		$f = 1.0\text{ GHz}$	11.0	16.5	
		$f = 2.0\text{ GHz}$		12.0	
		$f = 4.0\text{ GHz}$		7.5	
S _{21E} ²	Insertion Power Gain: $V_{CE} = 8\text{ V}, I_C = 10\text{ mA}$				
		$f = 2.0\text{ GHz}$		11.5	
		$f = 4.0\text{ GHz}$		6.0	
P ₁ dB	Power Output @ 1 dB Gain Compression: $V_{CE} = 8\text{ V}, I_C = 10\text{ mA}$			16.0	
G ₁ dB	1 dB Compressed Gain: $V_{CE} = 8\text{ V}, I_C = 10\text{ mA}$			11.5	
f _T	Gain Bandwidth Product: $V_{CE} = 8\text{ V}, I_C = 10\text{ mA}$			8.0	
h _{FE}	Forward Current Transfer Ratio: $V_{CE} = 8\text{ V}, I_C = 10\text{ mA}$		30	150	300
I _{CBO}	Collector Cutoff Current: $V_{CB} = 8\text{ V}$	μA			0.2
I _{EBO}	Emitter Cutoff Current: $V_{EB} = 1\text{ V}$	μA			1.0
CCB	Collector Base Capacitance ¹ : $V_{CB} = 8\text{ V}, f = 1\text{ MHz}$	pF		0.15	

Note: 1. For this test the emitter is grounded.

AT-60535

Low Noise Silicon Bipolar Transistor

Absolute Maximum Ratings

Parameter	Symbol	Absolute Maximum ¹
Emitter-Base Voltage	VEBO	1.5 V
Collector-Base Voltage	VCBO	20 V
Collector-Emitter Voltage	VCEO	12 V
Collector Current	IC	40 mA
Power Dissipation ^{2,3}	PT	400 mW
Junction Temperature	Tj	200°C
Storage Temperature ⁴	TSTG	-65°C to 200°C

Thermal Resistance^{2,5}: $\theta_{jC} = 225^\circ\text{C/W}$

Notes:

- Operation of this device above any one of these parameters may cause permanent damage.
- TCASE = 25°C.
- Derate at 4.4 mW/°C for $T_C > 110^\circ\text{C}$.
- Storage above +150°C may tarnish the leads of this package making it difficult to solder into a circuit. After a device has been soldered into a circuit, it may be safely stored up to 200°C.
- The small spot size of this technique results in a higher, though more accurate determination of θ_{jC} than do alternate methods. See MEASUREMENTS section "Thermal Resistance" for more information.

Typical Performance, $T_A = 25^\circ\text{C}$

(unless otherwise noted)

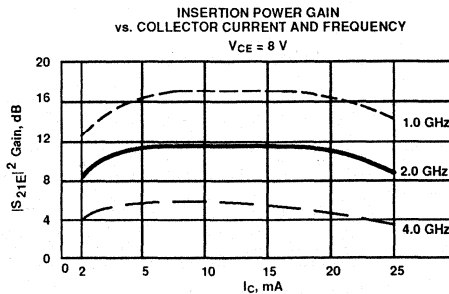
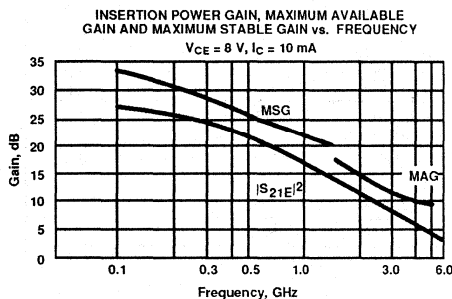
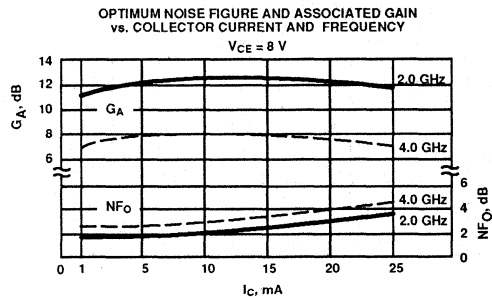
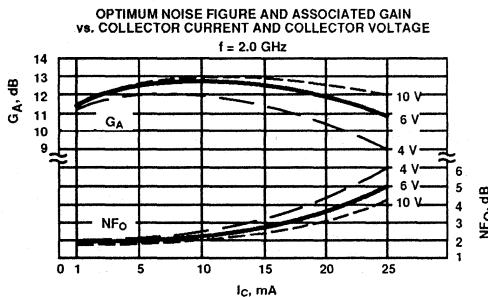
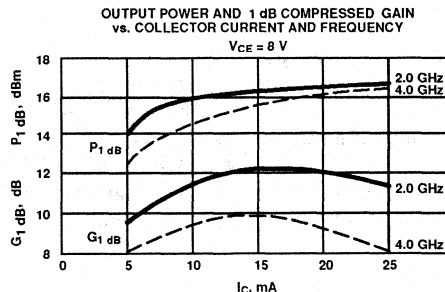

AT-60535
Low Noise Silicon Bipolar Transistor

Typical Scattering Parameters: Common Emitter, $Z_0 = 50 \Omega$

$T_A = 25^\circ\text{C}$, $V_{CE} = 8 \text{ V}$, $I_C = 2 \text{ mA}$

Freq. GHz	S_{11}		S_{21}			S_{12}			S_{22}	
	Mag	Ang	dB	Mag	Ang	dB	Mag	Ang	Mag	Ang
0.1	.94	-10	16.6	6.77	171	-39.2	.011	92	.99	-4
0.5	.83	-47	15.3	5.80	139	-27.6	.042	63	.92	-17
1.0	.64	-84	12.7	4.33	109	-23.8	.065	44	.81	-27
1.5	.50	-111	10.6	3.38	90	-22.4	.075	41	.74	-33
2.0	.42	-137	8.7	2.73	74	-21.6	.083	37	.70	-38
2.5	.37	-156	7.5	2.33	64	-21.0	.090	38	.67	-40
3.0	.37	-177	7.4	2.02	51	-20.8	.092	43	.66	-47
3.5	.37	164	5.0	1.77	39	-19.7	.103	41	.66	-56
4.0	.36	148	4.0	1.57	27	-19.2	.110	42	.67	-64
4.5	.37	131	3.0	1.42	17	-18.3	.121	42	.69	-70
5.0	.38	113	2.2	1.29	6	-17.1	.140	43	.69	-76
5.5	.43	93	1.5	1.19	-3	-15.9	.159	39	.69	-82
6.0	.50	80	0.8	1.09	-14	-15.0	.178	36	.66	-91

$T_A = 25^\circ\text{C}$, $V_{CE} = 8 \text{ V}$, $I_C = 10 \text{ mA}$

0.1	.77	-24	27.0	22.31	160	-41.0	.009	76	.96	-8
0.5	.47	-90	22.0	12.51	113	-31.0	.028	58	.72	-22
1.0	.33	-131	17.0	7.08	89	-27.2	.044	60	.63	-25
1.5	.28	-159	13.8	4.90	74	-25.0	.056	57	.60	-28
2.0	.27	176	11.5	3.77	63	-23.0	.070	58	.59	-33
2.5	.28	162	9.9	3.11	56	-21.6	.083	62	.57	-35
3.0	.30	149	8.4	2.64	46	-20.4	.096	60	.56	-43
3.5	.32	136	7.2	2.31	36	-19.1	.111	57	.57	-52
4.0	.33	124	6.2	2.04	26	-17.8	.129	53	.58	-60
4.5	.34	110	5.2	1.83	16	-16.7	.147	50	.60	-67
5.0	.36	95	4.4	1.67	6	-15.6	.166	45	.61	-73
5.5	.41	81	3.7	1.53	-2	-14.9	.180	40	.61	-79
6.0	.49	72	3.0	1.41	-12	-14.2	.196	36	.57	-87

A model for this device is available in the DEVICE MODELS section.

Features

- **Low Bias Current Operation:**
- **Low Noise Figure:** 1.8 dB typical at 2.0 GHz
2.8 dB typical at 4.0 GHz
- **High Associated Gain:** 12.5 dB typical at 2.0 GHz
8.0 dB typical at 4.0 GHz
- **High Gain-Bandwidth Product:** 8.0 GHz typical f_T
- **Hermetic Gold-ceramic Microstrip Package**

Description

Avantek's AT-60570 is a high performance NPN silicon bipolar transistor housed in a hermetic, high reliability package. This device is designed for use in low noise, wide band amplifier and oscillator applications operating over VHF, UHF and microwave frequencies.

Excellent device uniformity, performance and reliability are produced by the use of ion-implantation, self-alignment techniques, and gold metallization in the fabrication of these devices.

Avantek 70 mil Package

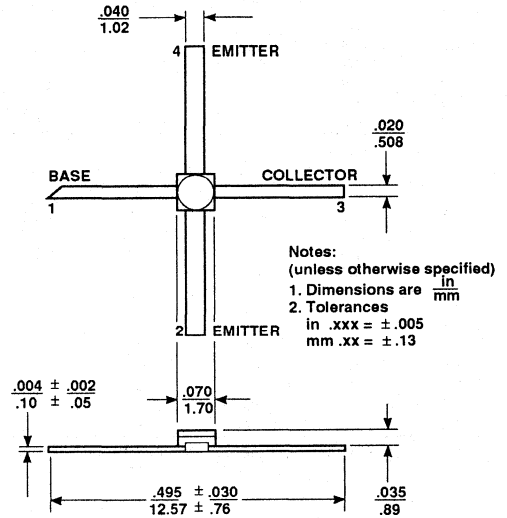

NOISE FIGURE AND ASSOCIATED GAIN vs. FREQUENCY
 $V_{CE} = 8\text{ V}, I_C = 2\text{ mA}$

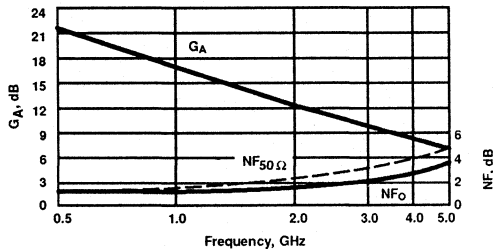

Noise Parameters: $V_{CE} = 8\text{ V}, I_C = 2\text{ mA}$

Freq. GHz	NF ₀ dB	Gamma Opt Mag	Ang	RN/50
1.0	1.4	.54	48	0.20
2.0	1.8	.44	98	0.28
4.0	2.8	.40	180	0.28

Electrical Specifications, $T_A = 25^\circ\text{C}$

Symbol	Parameters and Test Conditions	Units	Min.	Typ.	Max.
NF ₀	Optimum Noise Figure: $V_{CE} = 8\text{ V}, I_C = 2\text{ mA}$ $f = 1.0\text{ GHz}$ $f = 2.0\text{ GHz}$ $f = 4.0\text{ GHz}$	dB		1.4 1.8 2.8	2.1
GA	Gain @ NF ₀ : $V_{CE} = 8\text{ V}, I_C = 2\text{ mA}$ $f = 1.0\text{ GHz}$ $f = 2.0\text{ GHz}$ $f = 4.0\text{ GHz}$	dB	11.0	16.5 12.5 8.0	
$ S_{21E} ^2$	Insertion Power Gain: $V_{CE} = 8\text{ V}, I_C = 10\text{ mA}$ $f = 2.0\text{ GHz}$ $f = 4.0\text{ GHz}$	dB		12.0 6.5	
P ₁ dB	Power Output @ 1 dB Gain Compression: $V_{CE} = 8\text{ V}, I_C = 10\text{ mA}$ $f = 2.0\text{ GHz}$	dBm		16.0	
G ₁ dB	1 dB Compressed Gain: $V_{CE} = 8\text{ V}, I_C = 10\text{ mA}$ $f = 2.0\text{ GHz}$	dB		12.5	
f_T	Gain Bandwidth Product: $V_{CE} = 8\text{ V}, I_C = 10\text{ mA}$	GHz		8.0	
hFE	Forward Current Transfer Ratio: $V_{CE} = 8\text{ V}, I_C = 10\text{ mA}$		30	150	300
I _{CBO}	Collector Cutoff Current: $V_{CB} = 8\text{ V}$	μA			0.2
I _{EBO}	Emitter Cutoff Current: $V_{EB} = 1\text{ V}$	μA			1.0
CCB	Collector Base Capacitance ¹ : $V_{CB} = 8\text{ V}, f = 1\text{ MHz}$	pF		0.15	

Note: 1. For this test the emitter is grounded.

Absolute Maximum Ratings

Parameter	Symbol	Absolute Maximum ¹
Emitter-Base Voltage	VEBO	1.5 V
Collector-Base Voltage	VCBO	20 V
Collector-Emitter Voltage	VCEO	12 V
Collector Current	IC	40 mA
Power Dissipation ^{2,3}	PT	400 mW
Junction Temperature	Tj	200°C
Storage Temperature	TSTG	-65°C to 200°C

Thermal Resistance^{2,4}: $\theta_{JC} = 200^\circ\text{C/W}$

Notes:

1. Operation of this device above any one of these parameters may cause permanent damage.
2. TCASE = 25°C.
3. Derate at 5 mW/°C for TC > 120°C.
4. The small spot size of this technique results in a higher, though more accurate determination of θ_{JC} than do alternate methods. See MEASUREMENTS section "Thermal Resistance" for more information.

Typical Performance, TA = 25°C

(unless otherwise noted)

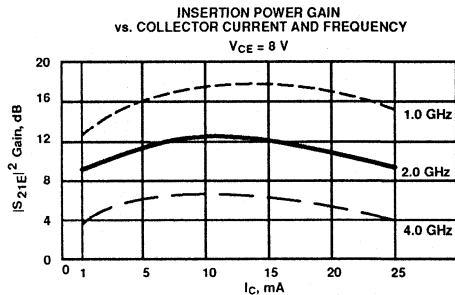
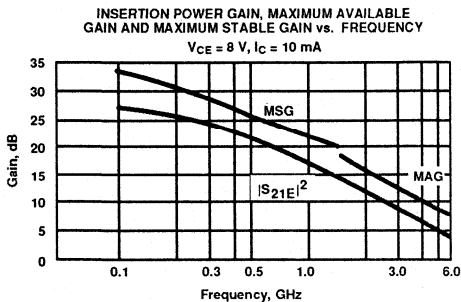
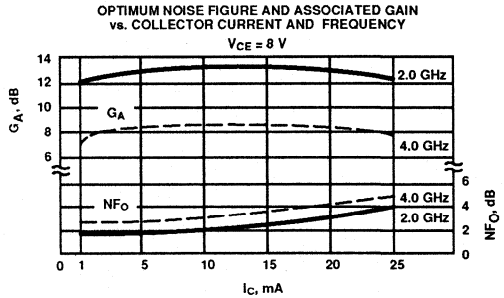
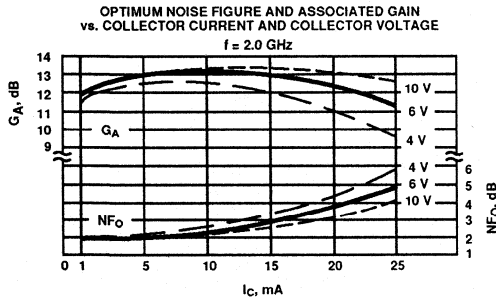
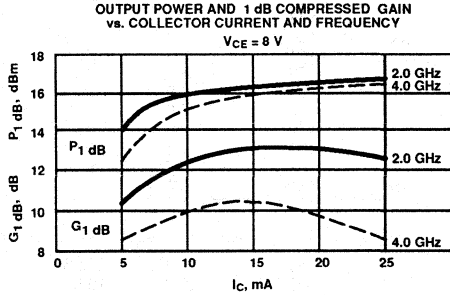

AT-60570
Low Noise Silicon Bipolar Transistor

Typical Scattering Parameters: Common Emitter, $Z_0 = 50 \Omega$

$T_A = 25^\circ\text{C}$, $V_{CE} = 8 \text{ V}$, $I_C = 2 \text{ mA}$

Freq. GHz	S ₁₁		S ₂₁			S ₁₂			S ₂₂	
	Mag	Ang	dB	Mag	Ang	dB	Mag	Ang	Mag	Ang
0.1	.95	-10	16.6	6.74	171	-38.4	.012	86	.99	-4
0.5	.86	-48	15.3	5.81	141	-27.2	.044	63	.92	-19
1.0	.72	-83	12.8	4.38	113	-23.0	.070	43	.81	-30
1.5	.62	-108	10.7	3.42	95	-22.0	.080	35	.74	-37
2.0	.56	-128	8.8	2.75	80	-21.2	.088	28	.70	-43
2.5	.52	-141	7.4	2.34	72	-20.6	.094	28	.67	-44
3.0	.51	-153	6.1	2.02	61	-20.8	.092	27	.66	-51
3.5	.51	-164	4.9	1.75	50	-20.4	.095	24	.67	-58
4.0	.49	-172	3.8	1.55	40	-20.0	.099	25	.67	-65
4.5	.48	-179	2.8	1.38	31	-19.8	.102	22	.69	-71
5.0	.46	-169	2.1	1.27	22	-19.5	.106	21	.69	-76
5.5	.44	-158	1.5	1.19	14	-19.2	.110	22	.70	-80
6.0	.44	-145	0.9	1.11	4	-18.4	.120	20	.69	-86

$T_A = 25^\circ\text{C}$, $V_{CE} = 8 \text{ V}$, $I_C = 10 \text{ mA}$

0.1	.77	-26	27.3	23.25	161	-39.2	.011	79	.96	-9
0.5	.57	-98	22.6	13.51	116	-31.0	.028	49	.69	-27
1.0	.49	-136	17.8	7.72	92	-27.8	.041	45	.58	-31
1.5	.45	-156	14.6	5.36	79	-26.2	.049	45	.54	-34
2.0	.44	-171	12.3	4.10	69	-24.6	.059	48	.53	-39
2.5	.44	-177	10.5	3.35	63	-23.0	.070	51	.52	-39
3.0	.45	-174	9.1	2.84	55	-23.0	.071	52	.52	-47
3.5	.45	-167	7.8	2.46	46	-21.4	.086	52	.53	-56
4.0	.44	-160	6.7	2.16	37	-20.2	.097	50	.55	-63
4.5	.42	-153	5.7	1.92	29	-19.3	.108	47	.57	-70
5.0	.40	-144	4.9	1.75	21	-18.7	.116	44	.59	-75
5.5	.40	-132	4.2	1.62	13	-18.1	.124	41	.60	-79
6.0	.41	-121	3.5	1.49	4	-17.3	.137	38	.60	-86

A model for this device is available in the DEVICE MODELS section.

Features

- Low Bias Current Operation
- Low Noise Figure: 1.4 dB typical at 1.0 GHz
1.9 dB typical at 2.0 GHz
- High Associated Gain: 16.5 dB typical at 1.0 GHz
11.5 dB typical at 2.0 GHz
- High Gain-Bandwidth Product: 8.0 GHz typical f_T
- Low Cost Plastic Package

Description

Avantek's AT-60585 is a high performance NPN silicon bipolar transistor housed in a low cost plastic package. This device is designed for use in low noise, wide band amplifier and oscillator applications operating over VHF, UHF and microwave frequencies.

Excellent device uniformity, performance and reliability are produced by the use of ion-implantation, self-alignment techniques, and gold metallization in the fabrication of these devices.

Avantek 85 Plastic Package

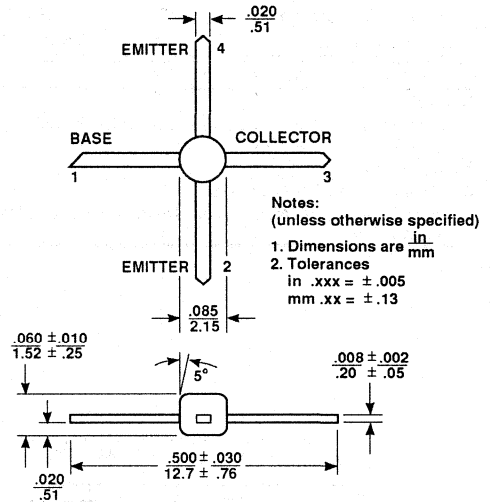

NOISE FIGURE AND ASSOCIATED GAIN vs. FREQUENCY
 $V_{CE} = 8\text{ V}, I_C = 2\text{ mA}$

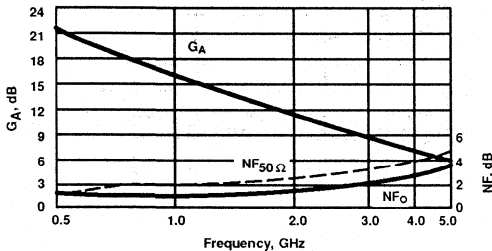

Noise Parameters: $V_{CE} = 8\text{ V}, I_C = 2\text{ mA}$

Freq. GHz	NF_0 dB	Gamma Mag	Opt Ang	$R_N/50$
1.0	1.4	.50	53	0.32
2.0	1.9	.44	108	0.34
4.0	2.9	.40	-144	0.46

Electrical Specifications, $T_A = 25^\circ\text{C}$

Symbol	Parameters and Test Conditions	Units	Min.	Typ.	Max.
NF_0	Optimum Noise Figure: $V_{CE} = 8\text{ V}, I_C = 2\text{ mA}$				
	$f = 1.0\text{ GHz}$	dB		1.4	1.8
	$f = 2.0\text{ GHz}$			1.9	
	$f = 4.0\text{ GHz}$			2.9	
G_A	Gain @ NF_0 : $V_{CE} = 8\text{ V}, I_C = 2\text{ mA}$				
	$f = 1.0\text{ GHz}$	dB	15.0	16.5	
	$f = 2.0\text{ GHz}$			11.5	
	$f = 4.0\text{ GHz}$			7.5	
$ S_{21E} ^2$	Insertion Power Gain: $V_{CE} = 8\text{ V}, I_C = 10\text{ mA}$				
	$f = 1.0\text{ GHz}$	dB		17.0	
	$f = 2.0\text{ GHz}$			11.5	
P_1 dB	Power Output @ 1 dB Gain Compression: $V_{CE} = 8\text{ V}, I_C = 10\text{ mA}$	dBm		15.0	
G_1 dB	1 dB Compressed Gain: $V_{CE} = 8\text{ V}, I_C = 10\text{ mA}$	dB		11.5	
f_T	Gain Bandwidth Product: $V_{CE} = 8\text{ V}, I_C = 10\text{ mA}$	GHz		8.0	
hFE	Forward Current Transfer Ratio: $V_{CE} = 8\text{ V}, I_C = 10\text{ mA}$		30	150	300
I_{CBO}	Collector Cutoff Current: $V_{CB} = 8\text{ V}$	μA			0.2
I_{EBO}	Emitter Cutoff Current: $V_{EB} = 1\text{ V}$	μA			1.0
CCB	Collector Base Capacitance ¹ : $V_{CB} = 8\text{ V}, f = 1\text{ MHz}$	pF		0.2	

Note: 1. For this test the emitter is grounded.

AT-60585

Low Noise Silicon Bipolar Transistor

Absolute Maximum Ratings

Parameter	Symbol	Absolute Maximum ¹
Emitter-Base Voltage	VEBO	1.5 V
Collector-Base Voltage	VCBO	20 V
Collector-Emitter Voltage	VCEO	12 V
Collector Current	IC	40 mA
Power Dissipation ^{2,3}	PT	400 mW
Junction Temperature	Tj	150°C
Storage Temperature	TSTG	-65°C to 150°C

Thermal Resistance^{2,4}: $\theta_{JC} = 180^\circ\text{C/W}$

Notes:

1. Operation of this device above any one of these parameters may cause permanent damage.
2. TCASE = 25°C.
3. Derate at 5.6 mW/°C for TC > 78°C.
4. See MEASUREMENTS section "Thermal Resistance" for more information.

Typical Performance, TA = 25°C

(unless otherwise noted)

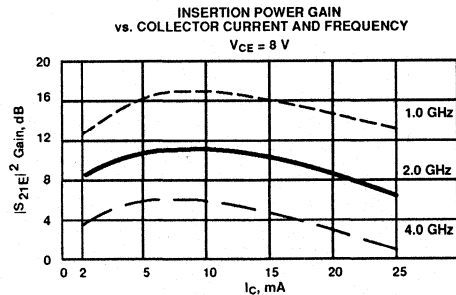
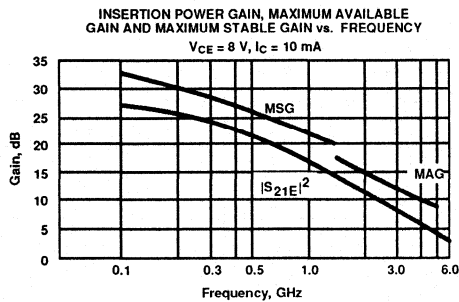
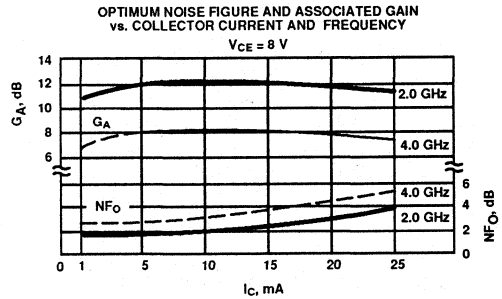
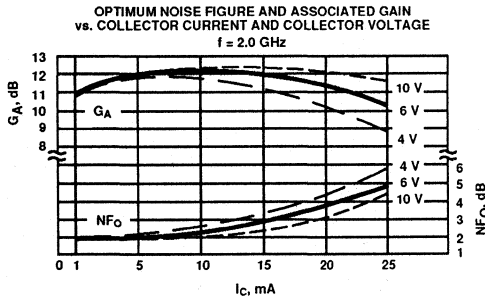
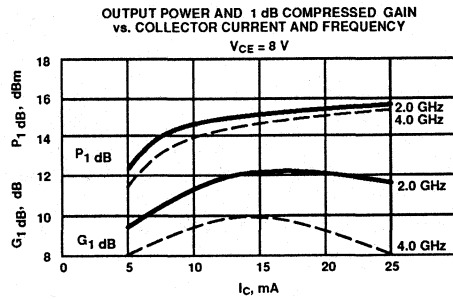

AT-60585
Low Noise Silicon Bipolar Transistor

Typical Scattering Parameters: Common Emitter, $Z_O = 50 \Omega$

$T_A = 25^\circ\text{C}$, $V_{CE} = 8 \text{ V}$, $I_C = 2 \text{ mA}$

Freq. GHz	S_{11}		S_{21}			S_{12}			S_{22}	
	Mag	Ang	dB	Mag	Ang	dB	Mag	Ang	Mag	Ang
0.1	.95	-10	16.3	6.56	171	-38.5	.012	82	.99	-4
0.5	.84	-30	15.1	5.66	139	-26.0	.050	61	.90	-18
1.0	.67	-86	12.5	4.22	110	-22.6	.074	43	.78	-29
1.5	.55	-114	10.4	3.29	90	-21.1	.088	35	.70	-35
2.0	.48	-139	8.4	2.64	74	-20.3	.096	29	.65	-41
2.5	.44	-155	7.0	2.25	65	-20.4	.096	31	.63	-41
3.0	.44	-174	5.7	1.92	53	-19.9	.101	32	.60	-48
3.5	.44	171	4.5	1.67	42	-19.7	.104	28	.62	-54
4.0	.44	157	3.3	1.47	30	-19.2	.109	29	.63	-61
4.5	.44	144	2.3	1.31	20	-18.8	.115	30	.65	-66
5.0	.44	128	1.5	1.19	11	-18.2	.124	29	.66	-70
5.5	.47	110	0.8	1.10	1	-17.4	.135	29	.64	-74
6.0	.52	94	0.1	1.01	-9	-16.7	.146	27	.62	-80

$T_A = 25^\circ\text{C}$, $V_{CE} = 8 \text{ V}$, $I_C = 10 \text{ mA}$

0.1	.73	-28	27.0	22.47	160	-39.5	.011	84	.96	-9
0.5	.52	-105	21.9	12.44	113	-30.8	.029	49	.68	-23
1.0	.44	-145	16.9	7.00	90	-28.1	.039	51	.58	-25
1.5	.41	-168	13.7	4.85	76	-25.8	.051	57	.55	-28
2.0	.41	174	11.4	3.70	65	-24.2	.061	57	.53	-33
2.5	.42	165	9.7	3.06	60	-22.8	.072	58	.51	-34
3.0	.44	155	8.1	2.56	51	-21.3	.086	64	.50	-42
3.5	.46	145	7.0	2.23	41	-20.2	.098	60	.50	-50
4.0	.46	136	5.8	1.96	32	-18.8	.114	58	.52	-59
4.5	.46	127	4.9	1.75	23	-17.7	.130	57	.53	-65
5.0	.47	115	4.0	1.58	14	-17.0	.141	52	.54	-71
5.5	.50	103	3.3	1.46	5	-16.0	.159	47	.54	-75
6.0	.55	91	2.5	1.34	-3	-15.0	.177	42	.51	-84

A model for this device is available in the DEVICE MODELS section.

Features

- Low Bias Current Operation
- Low Noise Figure: 1.4 dB typical at 1.0 GHz
1.9 dB typical at 2.0 GHz
- High Associated Gain: 16.0 dB typical at 1.0 GHz
11.0 dB typical at 2.0 GHz
- High Gain-Bandwidth Product: 8.0 GHz typical f_T
- Surface Mount Plastic Package
- Tape-and-Reel Packaging Option Available¹

Description

Avantek's AT-60586 is a high performance NPN silicon bipolar transistor housed in a low cost, surface mount plastic package. This device is designed for use in low noise, wide band amplifier and oscillator applications operating over VHF, UHF and microwave frequencies.

Excellent device uniformity, performance and reliability are produced by the use of ion-implantation, self-alignment techniques, and gold metallization in the fabrication of these devices.

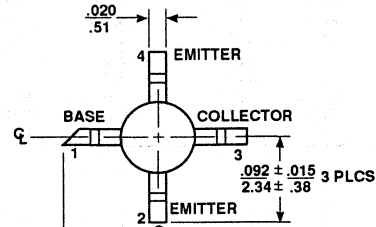
Avantek 86 Plastic Package

Notes:
(unless otherwise specified)

1. Dimensions are $\frac{\text{in}}{\text{mm}}$
2. Tolerances in .xxx = $\pm .005$
mm.xx = $\pm .13$

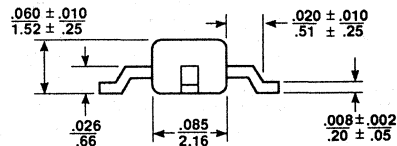

NOISE FIGURE AND ASSOCIATED GAIN
vs. FREQUENCY
 $V_{CE} = 8 \text{ V}$, $I_C = 2 \text{ mA}$

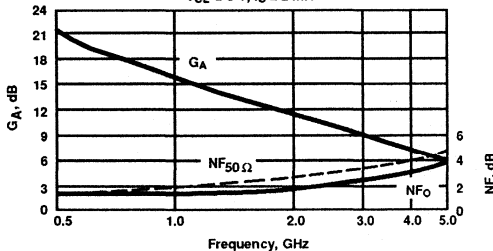
Electrical Specifications, $T_A = 25^\circ\text{C}$

Symbol	Parameters and Test Conditions	Units	Min.	Typ.	Max.
NF ₀	Optimum Noise Figure: $V_{CE} = 8 \text{ V}$, $I_C = 2 \text{ mA}$				
	$f = 1.0 \text{ GHz}$	dB		1.4	1.8
	$f = 2.0 \text{ GHz}$			1.9	
	$f = 4.0 \text{ GHz}$			2.9	
G_A	Gain @ NF ₀ : $V_{CE} = 8 \text{ V}$, $I_C = 2 \text{ mA}$				
	$f = 1.0 \text{ GHz}$	dB	14.5	16.0	
	$f = 2.0 \text{ GHz}$			11.0	
	$f = 4.0 \text{ GHz}$			7.0	
$ S_{21E} ^2$	Insertion Power Gain: $V_{CE} = 8 \text{ V}$, $I_C = 10 \text{ mA}$				
	$f = 1.0 \text{ GHz}$	dB		17.0	
	$f = 2.0 \text{ GHz}$			11.5	
P_1 dB	Power Output @ 1 dB Gain Compression: $V_{CE} = 8 \text{ V}$, $I_C = 10 \text{ mA}$	dBm		14.5	
G_1 dB	1 dB Compressed Gain: $V_{CE} = 8 \text{ V}$, $I_C = 10 \text{ mA}$	dB		10.5	
f_T	Gain Bandwidth Product: $V_{CE} = 8 \text{ V}$, $I_C = 10 \text{ mA}$	GHz		8.0	
h_{FE}	Forward Current Transfer Ratio: $V_{CE} = 8 \text{ V}$, $I_C = 10 \text{ mA}$		30	150	300
ICBO	Collector Cutoff Current: $V_{CB} = 8 \text{ V}$	μA			0.2
IEBO	Emitter Cutoff Current: $V_{EB} = 1 \text{ V}$	μA			1.0
CCB	Collector Base Capacitance ² : $V_{CB} = 8 \text{ V}$, $f = 1 \text{ MHz}$	pF		0.2	

Notes: 1. Refer to PACKAGING section "Tape-and-Reel Packaging for Surface Mount Semiconductors".
2. For this test, the emitter is grounded.

Absolute Maximum Ratings

Parameter	Symbol	Absolute Maximum ¹
Emitter-Base Voltage	VEBO	1.5 V
Collector-Base Voltage	VCBO	20 V
Collector-Emitter Voltage	VCEO	12 V
Collector Current	IC	40 mA
Power Dissipation ^{2,3}	PT	400 mW
Junction Temperature	TJ	150°C
Storage Temperature	TSTG	-65°C to 150°C

Thermal Resistance^{2,4}: $\theta_{jC} = 190^\circ\text{C/W}$

Notes:

1. Operation of this device above any one of these parameters may cause permanent damage.
2. TCASE = 25°C.
3. Derate at 5.3 mW/°C for TC > 74°C.
4. See MEASUREMENTS section "Thermal Resistance" for more information.

Part Number Ordering Information

Part Number	Devices Per Reel	Reel Size
AT-60586-TR1	1000	7"
AT-60586-TR2	4000	13"

Typical Performance, TA = 25°C

(unless otherwise noted)

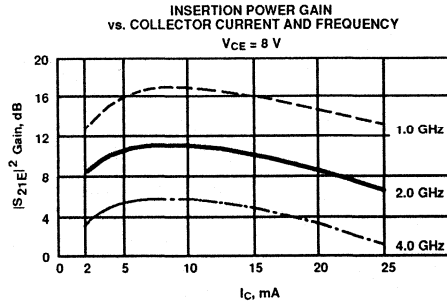
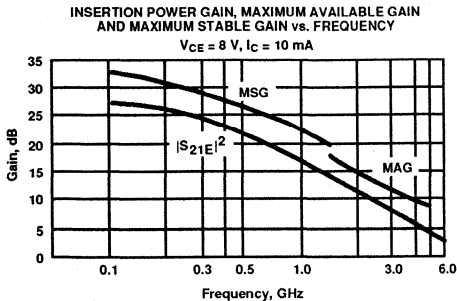
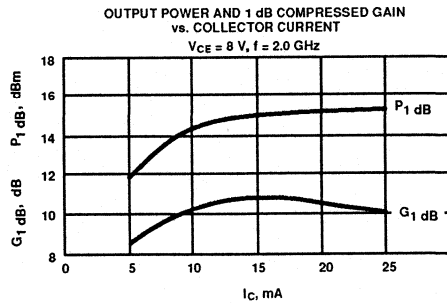
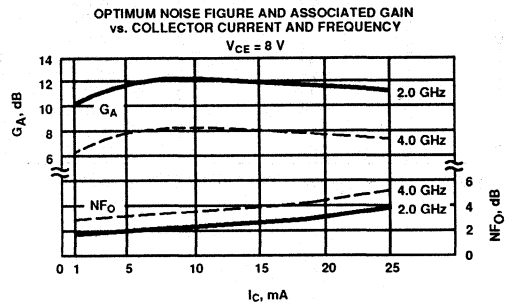
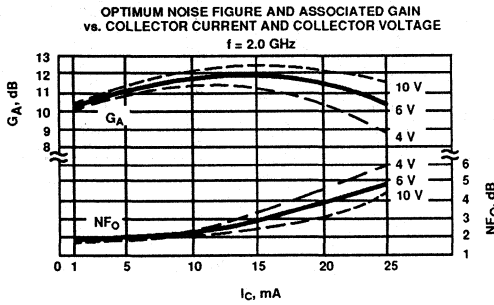

AT-60586
Low Noise Silicon Bipolar Transistor

Typical Scattering Parameters: Common Emitter, $Z_0 = 50 \Omega$

$T_A = 25^\circ\text{C}$, $V_{CE} = 8 \text{ V}$, $I_C = 2 \text{ mA}$

Freq. GHz	S_{11}		S_{21}			S_{12}			S_{22}	
	Mag	Ang	dB	Mag	Ang	dB	Mag	Ang	Mag	Ang
0.1	.95	-10	16.4	6.60	171	-39.7	.010	81	.99	-4
0.5	.83	-50	15.2	5.76	139	-25.8	.051	63	.90	-18
1.0	.65	-91	12.6	4.26	110	-21.7	.082	43	.76	-29
1.5	.55	-125	10.5	3.36	88	-20.6	.093	33	.67	-36
2.0	.50	-153	8.5	2.64	71	-20.1	.099	29	.61	-42
2.5	.49	-173	7.1	2.27	60	-19.6	.105	29	.58	-45
3.0	.49	166	5.8	1.94	46	-19.6	.105	24	.55	-51
3.5	.51	151	4.6	1.69	34	-18.8	.114	25	.54	-59
4.0	.54	138	3.4	1.48	23	-18.5	.119	24	.52	-68
4.5	.58	127	2.5	1.34	12	-18.0	.125	25	.51	-77
5.0	.61	117	1.7	1.22	1	-17.3	.137	24	.51	-89
5.5	.63	109	1.0	1.12	-8	-16.7	.146	22	.50	-102
6.0	.65	102	0.3	1.03	-19	-15.9	.161	22	.50	-116

$T_A = 25^\circ\text{C}$, $V_{CE} = 8 \text{ V}$, $I_C = 10 \text{ mA}$

0.1	.76	-28	27.0	22.34	160	-40.8	.009	76	.95	-10
0.5	.51	-105	22.1	12.77	112	-30.2	.031	49	.66	-26
1.0	.42	-149	17.0	7.08	88	-26.5	.047	48	.54	-27
1.5	.42	-175	13.8	4.92	73	-24.9	.057	50	.49	-31
2.0	.44	165	11.5	3.75	60	-23.0	.071	51	.47	-36
2.5	.46	155	9.8	3.08	52	-21.3	.086	53	.45	-40
3.0	.48	143	8.2	2.56	42	-20.6	.093	48	.44	-46
3.5	.52	134	7.1	2.27	32	-19.1	.111	46	.42	-55
4.0	.55	125	6.0	2.00	22	-18.4	.120	44	.40	-64
4.5	.59	117	5.0	1.77	13	-17.3	.136	41	.39	-75
5.0	.62	110	4.1	1.61	3	-16.4	.151	36	.38	-88
5.5	.64	104	3.3	1.45	-5	-15.9	.160	34	.38	-100
6.0	.66	98	2.5	1.34	-15	-15.0	.178	30	.38	-117

A model for this device is available in the DEVICE MODELS section.

This page is intentionally blank.

Features

- **High Output Power:**
28.0 dBm typical $P_{1\text{ dB}}$ at 2.0 GHz
27.0 dBm typical $P_{1\text{ dB}}$ at 4.0 GHz
- **High Gain at 1 dB Compression:**
10.0 dB typical $G_{1\text{ dB}}$ at 2.0 GHz
6.5 dB typical $G_{1\text{ dB}}$ at 4.0 GHz
- **35% Total Efficiency**
- **Emitter Ballast Resistors**
- **Hermetic, Metal/Beryllia Microstrip Package**

Description

Avantek's AT-64020 is a high performance NPN silicon bipolar transistor housed in a hermetic BeO disk package for good thermal characteristics. This device is designed for use in medium power, wide band amplifier and oscillator applications operating over VHF, UHF and microwave frequencies.

Excellent device uniformity, performance and reliability are produced by the use of ion-implantation, self-alignment techniques, and gold metallization in the fabrication of these devices. The use of ion-implanted ballast resistors ensures uniform current distribution through the multiple emitter fingers.

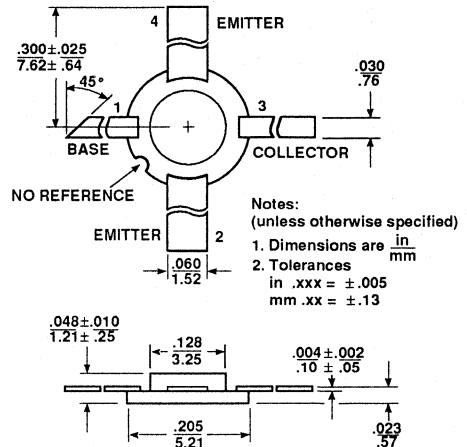
Avantek 200 mil BeO Package

POWER OUTPUT @ 1 dB GAIN COMPRESSION
vs. FREQUENCY AND COLLECTOR CURRENT
 $V_{CE} = 16\text{ V}$

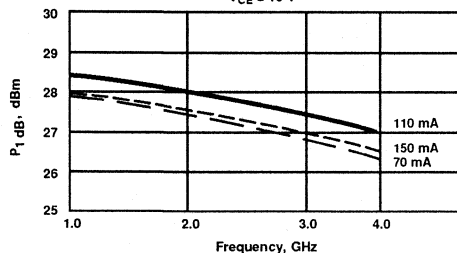
Electrical Specifications, $T_A = 25^\circ\text{C}$

Symbol	Parameters and Test Conditions	Units	Min.	Typ.	Max.
$P_{1\text{ dB}}$	Power Output @ 1 dB Gain Compression: $V_{CE} = 16\text{ V}$, $I_C = 110\text{ mA}$	f = 2.0 GHz f = 4.0 GHz	27.0	28.0 27.0	
$G_{1\text{ dB}}$	1 dB Compressed Gain: $V_{CE} = 16\text{ V}$, $I_C = 110\text{ mA}$	f = 2.0 GHz f = 4.0 GHz	9.0	10.0 6.5	
η_T	Total Efficiency ¹ at 1 dB Compression: $V_{CE} = 16\text{ V}$, $I_C = 110\text{ mA}$	f = 4.0 GHz		35.0	
$ S_{21E} ^2$	Insertion Power Gain: $V_{CE} = 16\text{ V}$, $I_C = 110\text{ mA}$	f = 2.0 GHz f = 4.0 GHz		7.0 2.0	
hFE	Forward Current Transfer Ratio: $V_{CE} = 8\text{ V}$, $I_C = 110\text{ mA}$		20	50	200
I_{CBO}	Collector Cutoff Current: $V_{CB} = 16\text{ V}$				100
I_{EBO}	Emitter Cutoff Current: $V_{EB} = 1\text{ V}$				5.0

Note: 1. $\eta_T = \frac{\text{RF Output Power}}{\text{RF Input Power} + V_{CE}I_C}$

Absolute Maximum Ratings

Parameter	Symbol	Absolute Maximum ¹
Emitter-Base Voltage	VEBO	2 V
Collector-Base Voltage	VCBO	40 V
Collector-Emitter Voltage	VCEO	20 V
Collector Current	IC	200 mA
Power Dissipation ^{2,3}	PT	3 W
Junction Temperature	TJ	200°C
Storage Temperature	TSTG	-65°C to 200°C

Thermal Resistance^{2,4}: $\theta_{jc} = 40^\circ\text{C/W}$

Notes:

1. Operation of this device above any one of these parameters may cause permanent damage.
2. TCASE = 25°C.
3. Derate at 25 mW/°C for TC > 80°C.
4. The small spot size of this technique results in a higher, though more accurate determination of θ_{jc} than do alternate methods. See MEASUREMENTS section "Thermal Resistance" for more information.

Typical Performance, TA = 25°C

(unless otherwise noted)

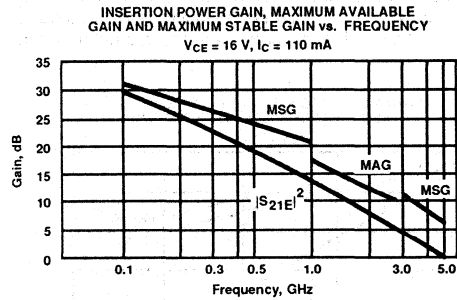
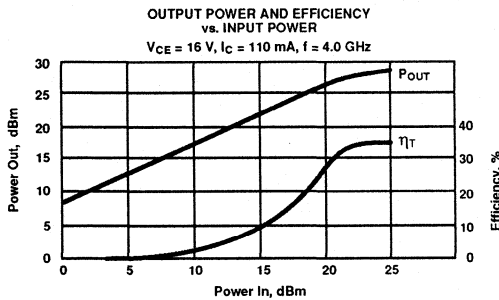
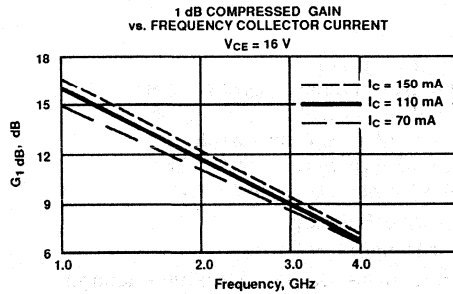

Typical Scattering Parameters: Common Emitter, ZO = 50 Ω

TA = 25°C, VCE = 16 V, IC = 110 mA

Freq. GHz	S11		S21			S12			S22	
	Mag	Ang	dB	Mag	Ang	dB	Mag	Ang	Mag	Ang
0.1	.61	-116	30.0	31.51	130	-33.1	.022	57	.67	-48
0.5	.75	-173	18.4	8.27	86	-28.8	.036	41	.23	-88
1.0	.75	171	12.5	4.23	66	-27.4	.043	49	.20	-100
1.5	.74	159	9.2	2.90	50	-23.5	.067	48	.21	-110
2.0	.74	148	7.0	2.23	35	-21.6	.083	46	.25	-120
2.5	.73	141	5.2	1.82	26	-19.8	.103	47	.27	-127
3.0	.73	130	3.8	1.56	12	-17.5	.133	41	.32	-135
3.5	.74	119	2.7	1.37	-2	-16.1	.157	35	.35	-146
4.0	.73	107	1.8	1.23	-16	-14.7	.186	26	.38	-158
4.5	.72	93	0.9	1.11	-30	-13.3	.217	18	.41	-168
5.0	.71	79	0.1	1.01	-43	-11.8	.256	8	.42	179

A model for this device is available in the DEVICE MODELS section.

Features

- **High Output Power:**
 28.0 dBm typical P_1 dB at 2.0 GHz
 27.0 dBm typical P_1 dB at 4.0 GHz
- **High Gain at 1 dB Compression:**
 12.5 dB typical G_1 dB at 2.0 GHz
 9.5 dB typical G_1 dB at 4.0 GHz
- **35% Total Efficiency**
- **Emitter Ballast Resistors**
- **Hermetic, Metal/Beryllia Stripline Package**

Description

Avantek's AT-64023 is a high performance NPN silicon bipolar transistor housed in a hermetic BeO flange package for good thermal characteristics. This device is designed for use in medium power, wide band amplifier and oscillator applications operating over VHF, UHF and microwave frequencies.

Excellent device uniformity, performance and reliability are produced by the use of ion-implantation, self-alignment techniques, and gold metallization in the fabrication of these devices. The use of ion-implanted ballast resistors ensures uniform current distribution through the multiple emitter fingers.

Avantek 230 mil BeO Flange Package

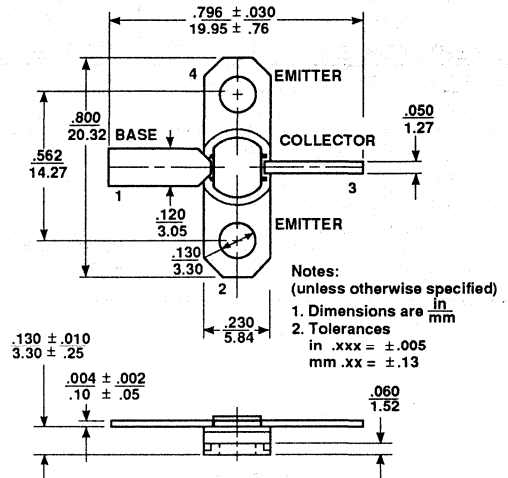

**POWER OUTPUT @ 1 dB GAIN COMPRESSION
 vs. FREQUENCY AND COLLECTOR CURRENT**
 $V_{CE} = 16\text{ V}$

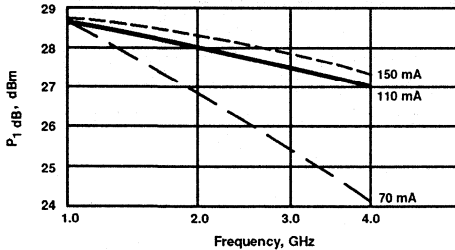

Electrical Specifications, $T_A = 25^\circ\text{C}$

Symbol	Parameters and Test Conditions	Units	Min.	Typ.	Max.
P_1 dB	Power Output @ 1 dB Gain Compression: $V_{CE} = 16\text{ V}, I_C = 110\text{ mA}$	f = 2.0 GHz f = 4.0 GHz		28.0 27.0	
G_1 dB	1 dB Compressed Gain: $V_{CE} = 16\text{ V}, I_C = 110\text{ mA}$	f = 2.0 GHz f = 4.0 GHz	25.5	12.5 9.5	
η_T	Total Efficiency ¹ at 1 dB Compression: $V_{CE} = 16\text{ V}, I_C = 110\text{ mA}$	f = 4.0 GHz		35.0	
$ S_{21E} ^2$	Insertion Power Gain: $V_{CE} = 16\text{ V}, I_C = 110\text{ mA}$	f = 2.0 GHz f = 4.0 GHz		6.5 2.0	
hFE	Forward Current Transfer Ratio: $V_{CE} = 8\text{ V}, I_C = 110\text{ mA}$		20	50	200
I_{CBO}	Collector Cutoff Current: $V_{CB} = 16\text{ V}$				100
I_{EBO}	Emitter Cutoff Current: $V_{EB} = 1\text{ V}$				5.0

Note: 1. $\eta_T = \frac{\text{RF Output Power}}{\text{RF Input Power} + V_{CE}I_C}$

Absolute Maximum Ratings

Parameter	Symbol	Absolute Maximum ¹
Emitter-Base Voltage	VEBO	2.2 V
Collector-Base Voltage	VCBO	40 V
Collector-Emitter Voltage	VCEO	20 V
Collector Current	IC	200 mA
Power Dissipation ^{2,3}	PT	3 W
Junction Temperature	Tj	200°C
Storage Temperature	TSTG	-65°C to 200°C

Thermal Resistance^{2,4}: $\theta_{jc} = 40^\circ\text{C/W}$

Notes:

1. Operation of this device above any one of these parameters may cause permanent damage.
2. TCASE = 25°C.
3. Derate at 25 mW/°C for TC > 80°C.
4. The small spot size of this technique results in a higher, though more accurate determination of θ_{jc} than do alternate methods. See MEASUREMENTS section "Thermal Resistance" for more information.

Typical Performance, TA = 25°C

(unless otherwise noted)

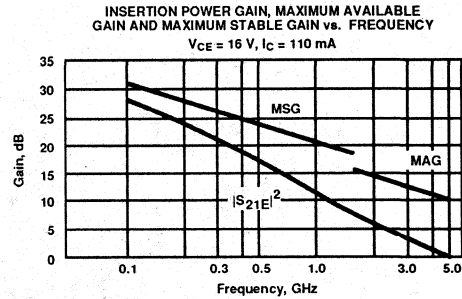
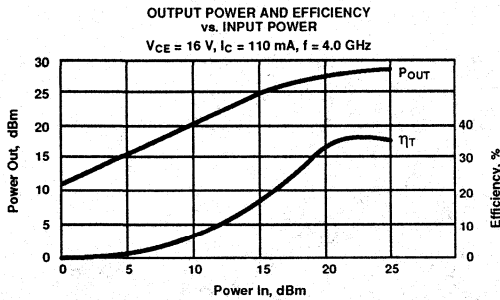
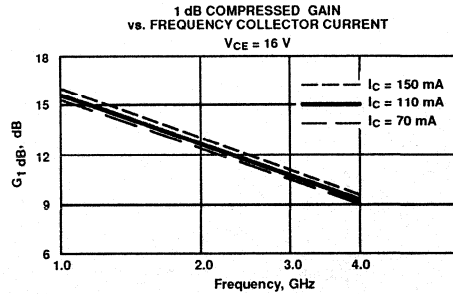

Typical Scattering Parameters: Common Emitter, ZO = 50 Ω

TA = 25°C, VCE = 16 V, IC = 110 mA

Freq. GHz	S11		S21			S12			S22	
	Mag	Ang	dB	Mag	Ang	dB	Mag	Ang	Mag	Ang
0.1	.54	-124	28.2	25.71	135	-33.3	.022	42	.72	-51
0.5	.80	-178	17.6	7.57	78	-29.5	.034	18	.33	-119
1.0	.80	162	11.9	3.92	47	-28.6	.037	10	.33	-142
1.5	.80	147	8.6	2.70	21	-27.9	.040	12	.40	-156
2.0	.78	133	6.3	2.07	-4	-27.6	.042	1	.48	-169
2.5	.77	127	5.1	1.80	-24	-25.5	.053	-5	.58	-178
3.0	.73	116	3.8	1.56	-51	-25.0	.056	-20	.67	170
3.5	.66	106	2.9	1.40	-79	-25.8	.051	-28	.78	156
4.0	.60	99	2.2	1.28	-109	-27.2	.044	-49	.86	142
4.5	.55	98	1.4	1.18	-141	-31.2	.028	-70	.93	127
5.0	.54	99	0.6	1.07	-175	-40.9	.009	-144	.93	112

A model for this device is available in the DEVICE MODELS section.

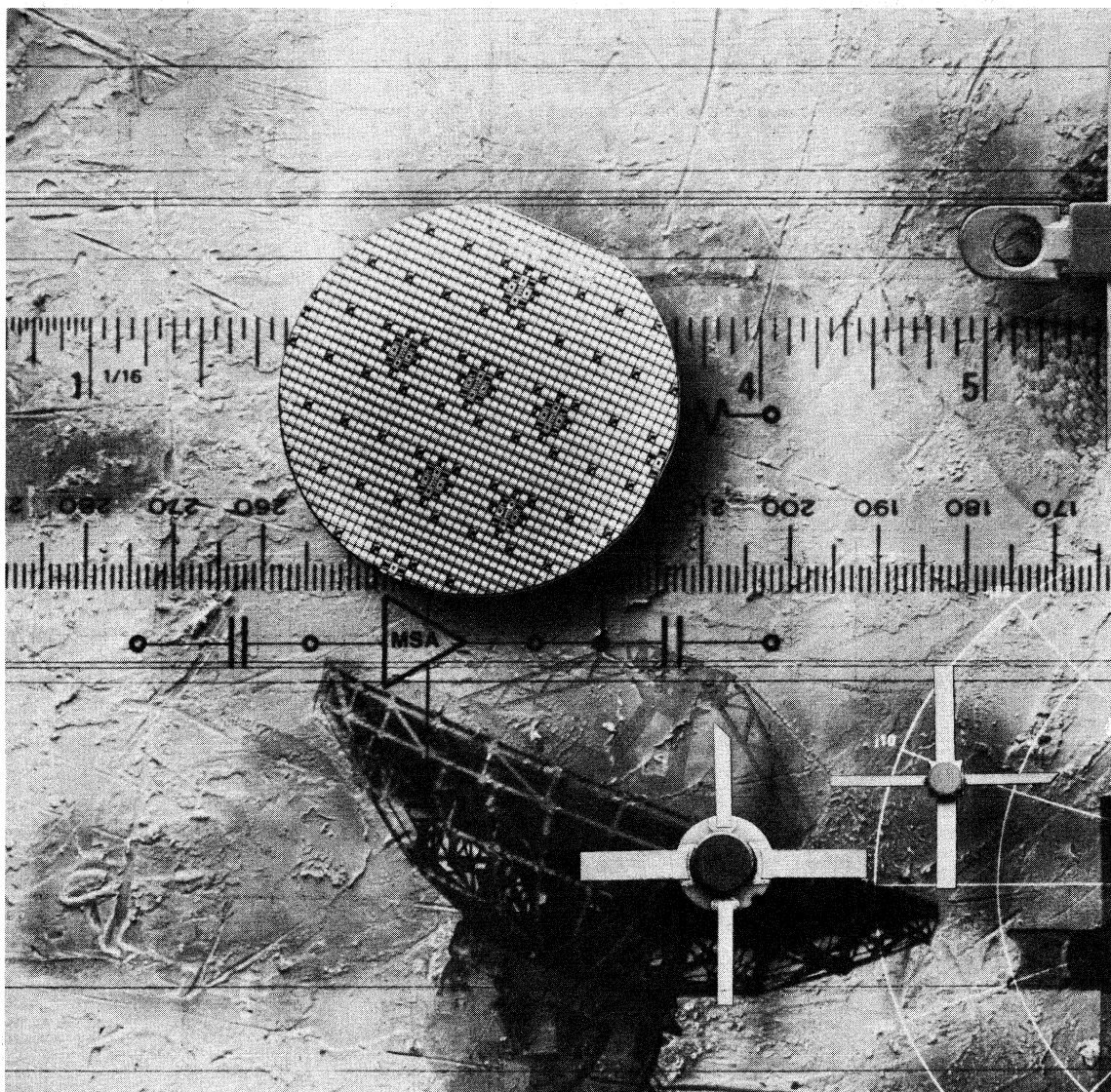

Gallium Arsenide FETs

SELECTION GUIDE 3-2

ATF-SERIES 3-6

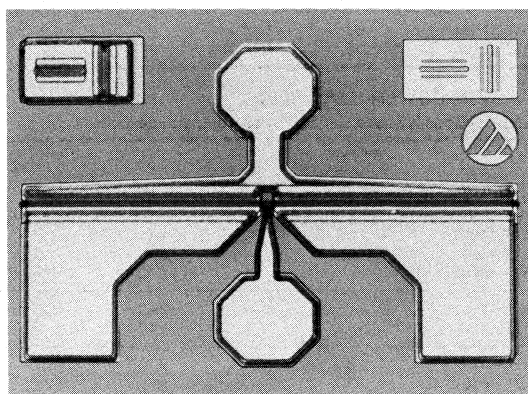
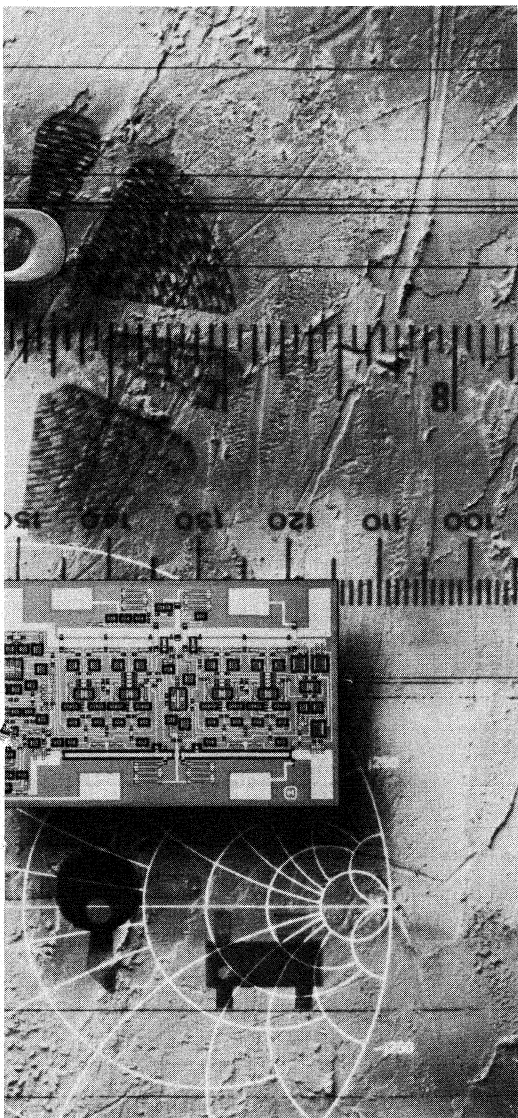

GALLIUM ARSENIDE FIELD EFFECT TRANSISTORS
LOW NOISE GaAs FETs

(Typical Specifications @ 25°C Case Temperature)

Model	Gate Width (um)	Optimum Frequency Range (GHz)	Test Frequency (GHz)	NF ₀ (dB)	Ga (dB)	P _{1dB} (dBm)	Case Type	Page Number
ATF-10100 ³	500	0.5-12	4	0.5	13.0	20.0	chip	-
ATF-13100	250	2-18	12	1.1	9.5	17.5	chip	3-15
ATF-21100	750	0.5-6	4	0.9	13.0	23.0	chip	3-31
ATF-25100	500	0.5-10	4	0.8	14.0	21.0	chip	3-36
ATF-10170 ³	500	0.5-12	4	0.5	13.0	20.0	70 mil stripline	-
ATF-13170	250	2-16	12	1.1	9.5	17.5	70 mil stripline	3-19
ATF-21170	750	0.5-6	4	0.9	13.0	23.0	70 mil stripline	3-34
ATF-25170	500	0.5-10	4	0.8	14.0	21.0	70 mil stripline	3-39
ATF-10136	500	0.5-12	4	0.5	13.0	20.0	micro-X ¹	3-6
ATF-10236	500	0.5-12	4	0.8	13.0	20.0	micro-X ¹	3-8
ATF-13036	250	2-16	12	1.1	9.5	17.5	micro-X ¹	3-13
ATF-13136	250	2-16	12	1.2	9.5	17.5	micro-X ¹	3-17
ATF-13336	250	2-16	12	1.4	9.0	17.5	micro-X ¹	3-23
ATF-13284	250	1-16	4	0.7	15.0	18.0	85 mil plastic ²	3-21

GENERAL PURPOSE GaAs FETs

(Typical Specifications @ 25°C Case Temperature)

Model	Gate Width (um)	Optimum Frequency Range (GHz)	Test Frequency (GHz)	NF ₀ (dB)	Ga (dB)	P _{1dB} (dBm)	Case Type	Page Number
ATF-21100	750	0.5-6	4	0.9	13.0	23.0	chip	3-31
ATF-25100	500	0.5-10	4	0.8	14.0	21.0	chip	3-36
ATF-26100	250	2-18	12	1.6	9.0	18.0	chip	3-45
ATF-26150	250	2-16	12	1.5	9.0	18.0	50 mil stripline	3-48
ATF-26350	250	2-16	12	1.7	9.0	18.0	50 mil stripline	3-50
ATF-26550	250	2-16	12	2.1	8.5	18.0	50 mil stripline	3-52
ATF-21170	750	0.5-6	4	0.9	13.0	23.0	70 mil stripline	3-34
ATF-25170	500	0.5-10	4	0.8	14.0	21.0	70 mil stripline	3-39
ATF-25570	500	0.5-10	4	1.0	14.0	20.5	70 mil stripline	3-41
ATF-25735	500	0.5-10	4	1.2	12.5	19.0	micro-X	3-43
ATF-10736	500	0.5-12	4	1.2	12.5	20.0	micro-X ¹	3-10
ATF-13736	250	2-16	12	1.8	9.0	17.5	micro-X ¹	3-28
ATF-13484	250	1-16	4	1.0	14.0	18.0	85 mil plastic ²	3-25
ATF-26884	250	2-16	12	2.2	9.0	18.0	85 mil plastic ²	3-56

MEDIUM POWER GaAs FETs

(Typical Specifications @ 25°C Case Temperature)

Model	Optimum Frequency Range (GHz)	Test Frequency (GHz)	P _{1dB} (dB)	G _{1dB} (dBm)	Case Type	Page Number
ATF-44100	2-8	4	32.0	9.0	chip	3-58
ATF-45100	2-12	4	29.0	11.0	chip	3-62
ATF-46100	2-14	4	27.0	12.0	chip	3-68
ATF-45171	2-8	4	29.0	10.5	70 mil flange	3-66
ATF-46171	2-10	4	27.0	11.0	70 mil flange	3-72
ATF-44101	2-8	4	32.0	9.0	100 mil flange	3-60
ATF-45101	2-8	4	29.0	10.0	100 mil flange	3-64
ATF-46101	2-10	4	27.0	10.0	100 mil flange	3-70

- Notes: 1. Lead length is trimmed to 40 mils typical.
 2. Lead length is trimmed to 65 mils typical.
 3. Recent product addition. Contact factory for data sheet.

SUGGESTED LOW NOISE & GENERAL PURPOSE GaAs FET LINEUPS
(Typical Performance)

LNB LINEUPS

4 GHz: Commercial

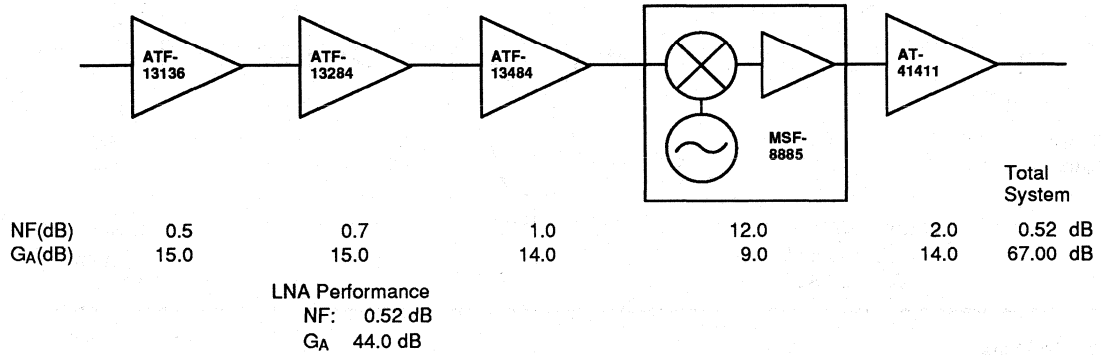

4 GHz: Commercial

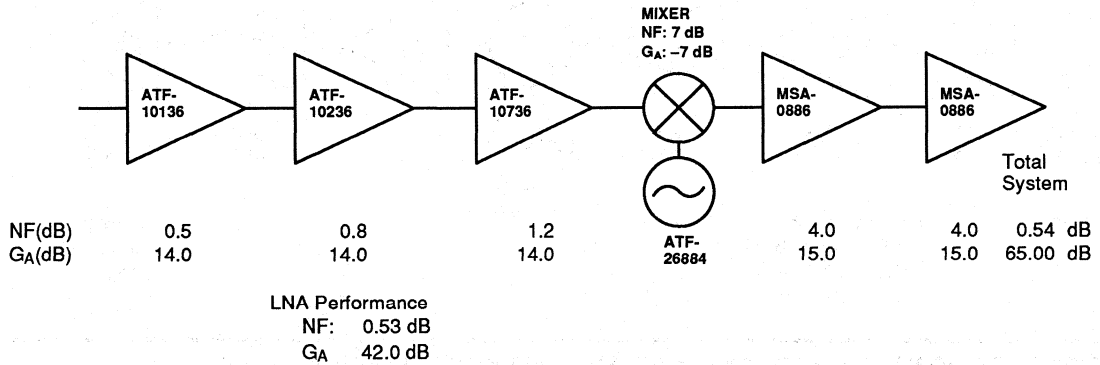

4 GHz: Military

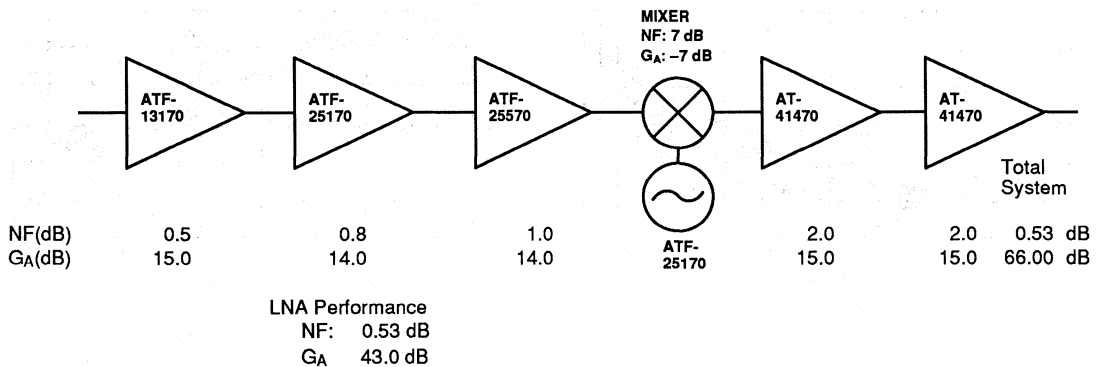

GaAs FET Selection Guide

SUGGESTED LOW NOISE & GENERAL PURPOSE GaAs FET LINEUPS (CONTINUED) (Typical Performance)

12 GHz: Commercial

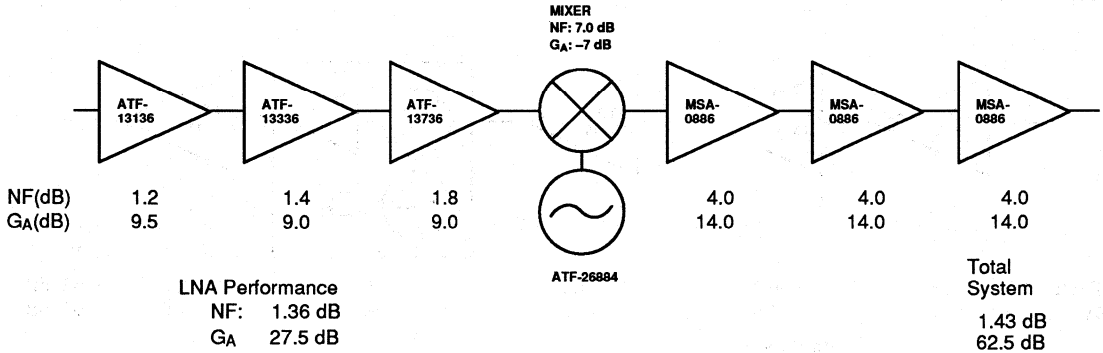

12 GHz: Military

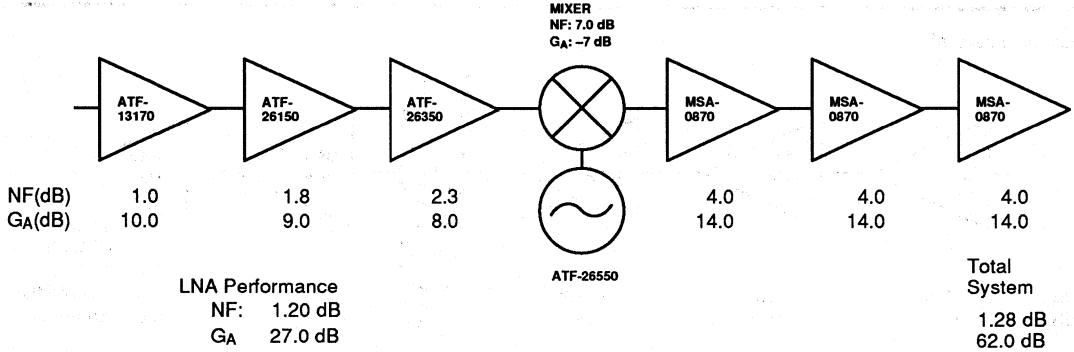

TYPICAL PERFORMANCE: LOW NOISE & GENERAL PURPOSE GaAs FETs @ T_A = 25°C

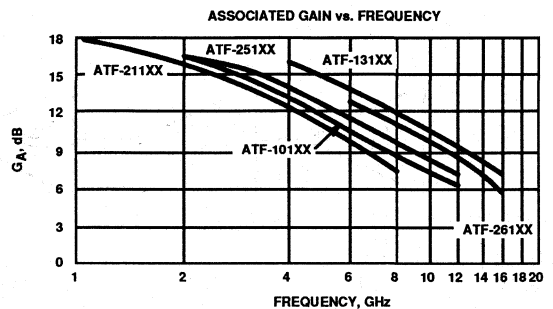
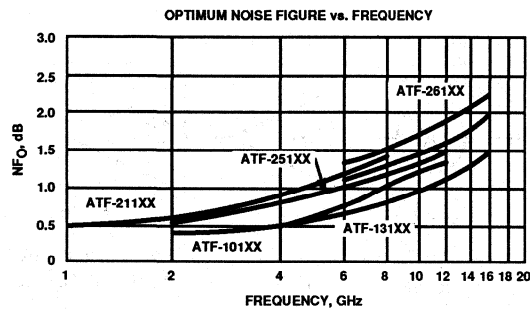

SUGGESTED MEDIUM POWER GaAs FETs LINEUPS (CONTINUED)

(Typical Performance)

POWER AMPLIFIERS

4 GHz: 1 Watt

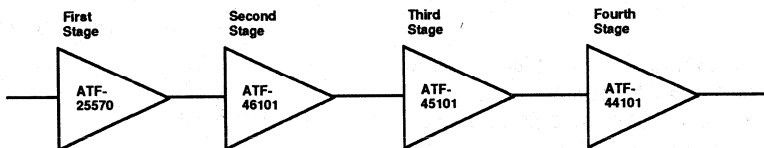

Power Input = -15 dBm
Gain per Stage (dB)
Total Power Output (dBm)

	13.0	10.0	10.0	9.0
	-2.0	11.0	21.0	30.0

8 GHz: 1/2 Watt

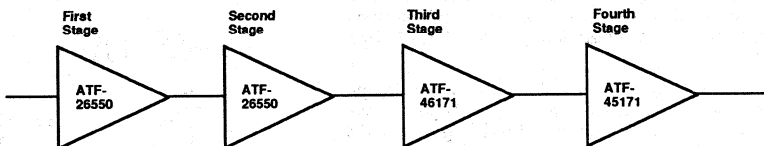

Power Input = -1.5 dBm
Gain per Stage (dB)
Total Power Output (dBm)

	9.0	9.0	6.0	4.5
	7.5	16.5	22.5	27.0

TYPICAL PERFORMANCE: MEDIUM POWER GaAs FETs @ T_A = 25°C

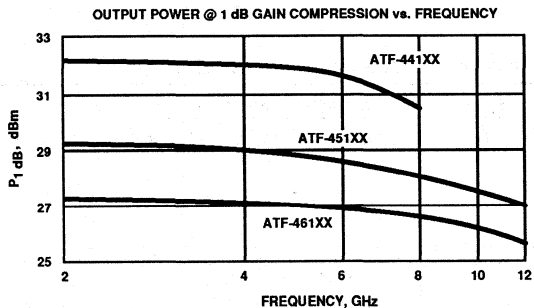
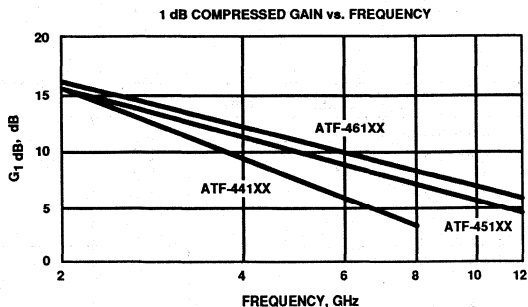

Features

- **Low Noise Figure: 0.5 dB typical at 4 GHz**
- **Low Bias: $V_{DS} = 2\text{ V}$, $I_{DS} = 20\text{ mA}$**
- **High Associated Gain: 13.0 dB typical at 4 GHz**
- **High Output Power: 20.0 dBm typical $P_1\text{ dB}$ at 4 GHz**
- **Cost Effective Ceramic Microstrip Package**
- **Tape-and-Reel Packaging Option Available²**

Description

Avantek's ATF-10136 is a high performance gallium arsenide Schottky-barrier-gate field effect transistor housed in a cost effective microstrip package. Its premium noise figure makes this device appropriate for use in the first stage of low noise amplifiers operating in the 0.5-12 GHz frequency range.

This GaAs FET device has a nominal 0.3 micron gate length using airbridge interconnects between drain fingers. Total gate periphery is 500 microns. Proven gold based metallization systems and nitride passivation assure a rugged, reliable device.

Avantek 36 micro-X Package¹

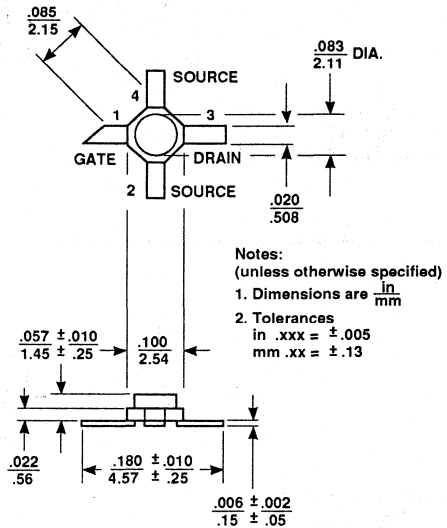

OPTIMUM NOISE FIGURE AND ASSOCIATED GAIN vs. FREQUENCY
 $V_{DS} = 2\text{ V}$, $I_{DS} = 25\text{ mA}$, $T_A = 25^\circ\text{C}$

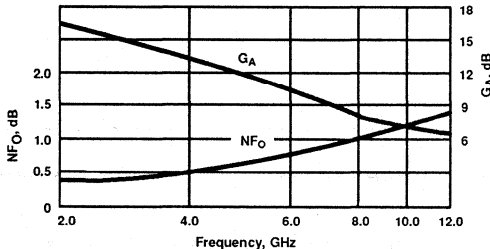

Noise Parameters: $V_{DS} = 2\text{ V}$, $I_{DS} = 25\text{ mA}$

Freq. GHz	NF ₀ dB	Gamma Mag	Opt Ang	R _{N/50}
1.0	0.4	.85	24	.70
2.0	0.4	.70	47	.46
4.0	0.5	.39	126	.36
6.0	0.8	.36	-170	.12
8.0	1.1	.45	-100	.38

Electrical Specifications, $T_A = 25^\circ\text{C}$

Symbol	Parameters and Test Conditions	Units	Min.	Typ.	Max.
NF ₀	Optimum Noise Figure: $V_{DS} = 2\text{ V}$, $I_{DS} = 25\text{ mA}$	f = 2.0 GHz f = 4.0 GHz f = 6.0 GHz		0.4 0.5 0.8	0.6
G _A	Gain @ NF ₀ : $V_{DS} = 2\text{ V}$, $I_{DS} = 25\text{ mA}$	f = 2.0 GHz f = 4.0 GHz f = 6.0 GHz	12.0	16.5 13.0 11.0	
P ₁ dB	Output Power @ 1 dB Gain Compression: $V_{DS} = 4\text{ V}$, $I_{DS} = 70\text{ mA}$	f = 4.0 GHz		20.0	
G ₁ dB	1dB Compressed Gain: $V_{DS} = 4\text{ V}$, $I_{DS} = 70\text{ mA}$	f = 4.0 GHz		12.0	
g _m	Transconductance: $V_{DS} = 2\text{ V}$, $V_{GS} = 0\text{ V}$		70	140	
I _{DSS}	Saturated Drain Current: $V_{DS} = 2\text{ V}$, $V_{GS} = 0\text{ V}$		40	130	200
V _p	Pinchoff Voltage: $V_{DS} = 2\text{ V}$, $I_{DS} = 1\text{ mA}$		-4.0	-1.3	-0.5

Notes: 1. Long leaded 35 Package available upon request.
 2. Refer to PACKAGING section "Tape-and-Reel Packaging for Surface Mount Semiconductors".

Absolute Maximum Ratings

Parameter	Symbol	Absolute Maximum ¹
Drain-Source Voltage	V _{DS}	+5 V
Gate-Source Voltage	V _{GS}	-4 V
Drain Current	I _{DS}	I _{DSS}
Power Dissipation ^{2,3}	P _T	430 mW
Channel Temperature	T _{CH}	175°C
Storage Temperature ⁴	T _{STG}	-65°C to +175°C

Thermal Resistance: $\theta_{JC} = 350^\circ\text{C/W}$; T_{CH} = 150°C
Liquid Crystal Measurement; 1 μm Spot Size⁵

Notes:

1. Operation of this device above any one of these parameters may cause permanent damage.
2. Case Temperature = 25°C.
3. Derate at 2.9 mW/°C for T_{CASE} > 25°C.
4. Storage above +150°C may tarnish the leads of this package difficult to solder into a circuit. After a device has been soldered into a circuit, it may be safely stored up to 175°C.
5. The small spot size of this technique results in a higher, though more accurate determination of θ_{JC} than do alternate methods. See MEASUREMENTS section for more information.

Part Number Ordering Information

Part Number	Devices Per Reel	Reel Size
ATF-10136-TR1	1000	7"
ATF-10136-TR2	4000	13"
ATF-10136-STR	1	STRIP

Typical Performance, T_A = 25°C

(unless otherwise noted)

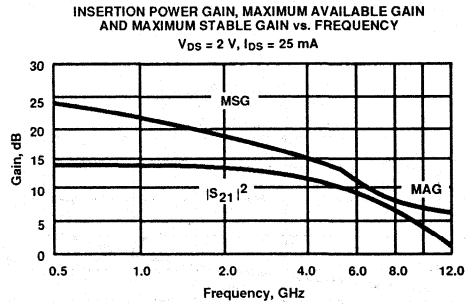
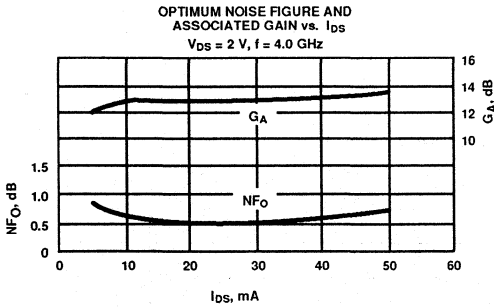

Typical Scattering Parameters: Common Source, Z₀ = 50 Ω

T_A = 25°C, V_{DS} = 2 V, I_{DS} = 25 mA

Freq. GHz	S ₁₁		S ₂₁			S ₁₂			S ₂₂	
	Mag	Ang	dB	Mag	Ang	dB	Mag	Ang	Mag	Ang
0.5	.98	-18	14.5	5.32	163	-34.0	.020	78	.35	-9
1.0	.93	-33	14.3	5.19	147	-28.4	.038	67	.36	-19
2.0	.79	-66	13.3	4.64	113	-22.6	.074	59	.30	-31
3.0	.64	-94	12.2	4.07	87	-19.2	.110	44	.27	-42
4.0	.54	-120	11.1	3.60	61	-17.3	.137	31	.22	-49
5.0	.47	-155	10.1	3.20	37	-15.5	.167	13	.16	-54
6.0	.45	162	9.2	2.88	13	-14.3	.193	-2	.08	-17
7.0	.50	120	8.0	2.51	-10	-13.9	.203	-19	.16	45
8.0	.60	87	6.4	2.09	-32	-13.6	.210	-36	.32	48
9.0	.68	61	4.9	1.75	-51	-13.6	.209	-46	.44	38
10.0	.73	42	3.6	1.52	-66	-13.7	.207	-58	.51	34
11.0	.77	26	2.0	1.26	-82	-13.8	.205	-73	.54	27
12.0	.80	14	1.0	1.12	-97	-14.0	.200	-82	.54	15

A model for this device is available in the DEVICE MODELS section.

Features

- Low Noise Figure: 0.8 dB typical at 4 GHz
- Low Bias: $V_{DS} = 2V$, $I_{DS} = 20\text{ mA}$
- High Associated Gain: 13.0 dB typical at 4 GHz
- High Output Power: 20.0 dBm typical P_1 dB at 4 GHz
- Cost Effective Ceramic Microstrip Package
- Tape-And-Reel Packaging Option Available²

Description

Avantek's ATF-10236 is a high performance gallium arsenide Schottky-barrier-gate field effect transistor housed in a cost effective microstrip package. Its low noise figure makes this device appropriate for use in the second stage of low noise amplifiers operating in the 0.5-12 GHz frequency range.

This GaAs FET device has a nominal 0.3 micron gate length using airbridge interconnects between drain fingers. Total gate periphery is 500 microns. Proven gold based metallization systems and nitride passivation assure a rugged, reliable device.

Avantek 36 micro-X Package¹

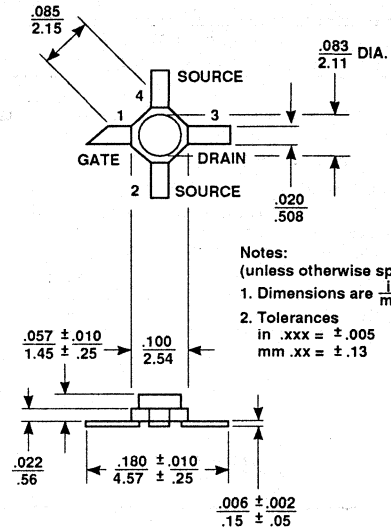

Notes:
(unless otherwise specified)
1. Dimensions are in mm
2. Tolerances in .xxx = ±.005 mm .xx = ±.13

OPTIMUM NOISE FIGURE AND ASSOCIATED GAIN vs. FREQUENCY
 $V_{DS} = 2\text{ V}$, $I_{DS} = 25\text{ mA}$, $T_A = 25^\circ\text{C}$

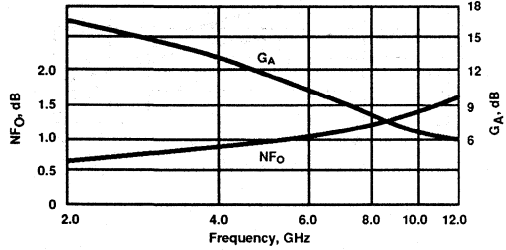

Noise Parameters: $V_{DS} = 2\text{ V}$, $I_{DS} = 25\text{ mA}$

Freq. GHz	NF ₀ dB	Gamma Opt Mag	Ang	R _N /50
1.0	0.5	.87	36	.63
2.0	0.6	.73	74	.33
4.0	0.8	.45	148	.15
6.0	1.0	.42	-137	.12
8.0	1.3	.49	-80	.45

Electrical Specifications, $T_A = 25^\circ\text{C}$

Symbol	Parameters and Test Conditions	Units	Min.	Typ.	Max.
NF ₀	Optimum Noise Figure: $V_{DS} = 2\text{ V}$, $I_{DS} = 25\text{ mA}$	f = 2.0 GHz dB f = 4.0 GHz dB f = 6.0 GHz dB		0.6 0.8 1.0	1.0
G _A	Gain @ NF ₀ : $V_{DS} = 2\text{ V}$, $I_{DS} = 25\text{ mA}$	f = 2.0 GHz dB f = 4.0 GHz dB f = 6.0 GHz dB	12.0	16.5 13.0 10.5	
P ₁ dB	Output Power @ 1 dB Gain Compression: $V_{DS} = 4\text{ V}$, $I_{DS} = 70\text{ mA}$	f = 4.0 GHz		20.0	
G ₁ dB	1 dB Compressed Gain: $V_{DS} = 4\text{ V}$, $I_{DS} = 70\text{ mA}$	f = 4.0 GHz		12.0	
g _m	Transconductance: $V_{DS} = 2\text{ V}$, $V_{GS} = 0\text{ V}$	mmho	80	140	
I _{DSS}	Saturated Drain Current: $V_{DS} = 2\text{ V}$, $V_{GS} = 0\text{ V}$	mA	50	130	180
V _p	Pinchoff Voltage: $V_{DS} = 2\text{ V}$, $I_{DS} = 1\text{ mA}$	V	-3.0	-1.3	-0.8

Notes: 1. Long leaded 35 package available upon request.
2. Refer to PACKAGING section "Tape-and-Reel Packaging for Surface Mount Semiconductors".

Absolute Maximum Ratings

Parameter	Symbol	Absolute Maximum ¹
Drain-Source Voltage	V _{DS}	+5 V
Gate-Source Voltage	V _{GS}	-4 V
Drain Current	I _{DS}	I _{DSS}
Power Dissipation ^{2,3}	PT	430 mW
Channel Temperature	T _{CH}	175°C
Storage Temperature ⁴	T _{STG}	175°C

Thermal Resistance: $\theta_{jc} = 350^\circ\text{C/W}$; $T_{CH} = 150^\circ\text{C}$
Liquid Crystal Measurement; 1 μm Spot Size⁵

Notes:

- Operation of this device above any one of these parameters may cause permanent damage.
- Case Temperature = 25°C.
- Derate at 2.9 mW/°C for T_{CASE} > 25°C.
- Storage above +150°C may tarnish the leads of this package making it difficult to solder into a circuit. After a device has been soldered into a circuit, it may be safely stored up to 175°C.
- The small spot size of this technique results in a higher, though more accurate determination of θ_{jc} than do alternate methods. See MEASUREMENTS section for more information.

Part Number Ordering Information

Part Number	Devices Per Reel	Reel Size
ATF-10236-TR1	1000	7"
ATF-10236-TR2	4000	13"
ATF-10236-STR	1	STRIP

Typical Performance, T_A = 25°C

(unless otherwise noted)

OPTIMUM NOISE FIGURE AND ASSOCIATED GAIN vs. I_{DS}
V_{DS} = 2 V, I_{DS} = 25 mA

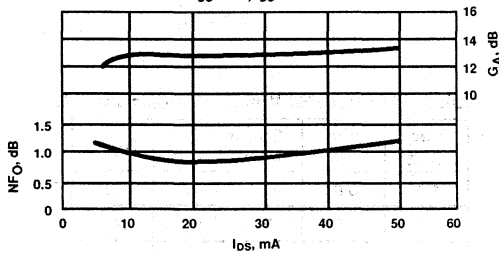

INSERTION POWER GAIN, MAXIMUM AVAILABLE GAIN AND MAXIMUM STABLE GAIN vs. FREQUENCY
V_{DS} = 2 V, I_{DS} = 25 mA

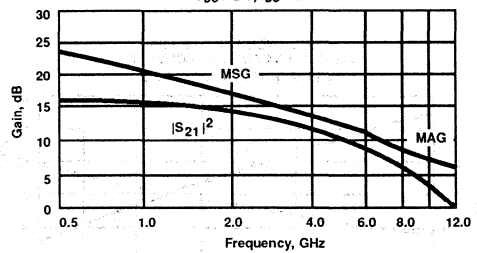

Typical Scattering Parameters: Common Source, Z₀ = 50 Ω

T_A = 25°C, V_{DS} = 2 V, I_{DS} = 25 mA

Freq. GHz	S ₁₁		S ₂₁			S ₁₂			S ₂₂	
	Mag	Ang	dB	Mag	Ang	dB	Mag	Ang	Mag	Ang
0.5	.97	-20	15.1	5.68	162	-32.8	.023	76	.47	-11
1.0	.93	-41	14.9	5.58	143	-26.0	.050	71	.45	-23
2.0	.77	-81	13.6	4.76	107	-21.3	.086	51	.36	-38
3.0	.59	-114	12.2	4.06	80	-18.4	.120	35	.30	-51
4.0	.48	-148	10.9	3.51	52	-16.5	.149	18	.23	-67
5.0	.46	166	9.6	3.03	26	-15.3	.172	3	.10	-67
6.0	.53	125	8.5	2.65	1	-14.5	.189	-14	.09	48
7.0	.62	96	6.9	2.22	-20	-14.4	.191	-28	.24	55
8.0	.71	73	4.9	1.75	-39	-14.5	.189	-41	.37	51
9.0	.75	54	3.3	1.47	-55	-14.7	.184	-46	.46	42
10.0	.78	39	2.1	1.28	-72	-14.9	.180	-59	.51	34
11.0	.82	26	0.3	1.04	-86	-14.9	.179	-71	.54	26
12.0	.84	12	-0.5	0.95	-101	-15.0	.177	-82	.54	17

A model for this device is available in the DEVICE MODELS section.

Features

- High Associated Gain: 12.5 dB typical at 4 GHz
- Low Bias: $V_{DS} = 2\text{ V}$, $I_{DS} = 20\text{ mA}$
- High Output Power: 20.0 dBm typical $P_1\text{ dB}$ at 4 GHz
- Low Noise Figure: 1.2 dB typical at 4 GHz
- Cost Effective Ceramic Microstrip Package
- Tape-and-Reel Packaging Option Available²

Description

Avantek's ATF-10736 is a high performance gallium arsenide Schottky-barrier-gate field effect transistor housed in a cost effective microstrip package. Its noise figure makes this device appropriate for use in the gain stages of low noise amplifiers operating in the 0.5-12 GHz frequency range.

This GaAs FET device has a nominal 0.3 micron gate length using airbridge interconnects between drain fingers. Total gate periphery is 500 microns. Proven gold based metallization systems and nitride passivation assure a rugged, reliable device.

Avantek 36 micro-X Package¹

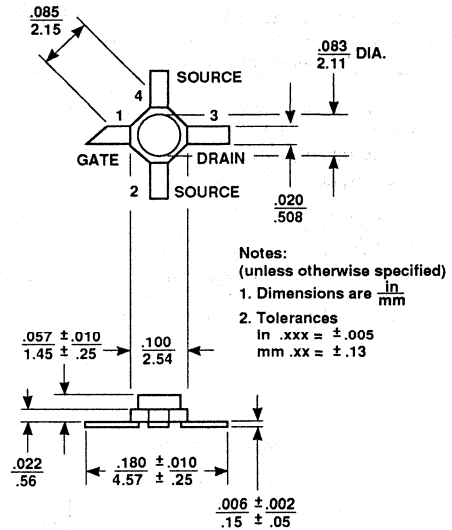

OPTIMUM NOISE FIGURE AND ASSOCIATED GAIN vs. FREQUENCY
 $V_{DS} = 2\text{ V}$, $I_{DS} = 25\text{ mA}$, $T_A = 25^\circ\text{C}$

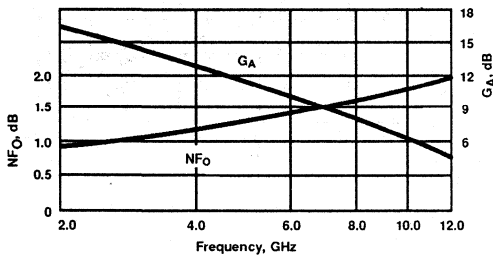

Noise Parameters: $V_{DS} = 2\text{ V}$, $I_{DS} = 25\text{ mA}$

Freq. GHz	NF ₀ dB	Gamma Mag	Opt Ang	R _N /50
1.0	0.8	.88	41	.52
2.0	0.9	.75	85	.27
4.0	1.2	.48	159	.08
6.0	1.4	.46	-122	.08
8.0	1.7	.53	-71	.43

Electrical Specifications, $T_A = 25^\circ\text{C}$

Symbol	Parameters and Test Conditions	Units	Min.	Typ.	Max.
NF ₀	Optimum Noise Figure: $V_{DS} = 2\text{ V}$, $I_{DS} = 25\text{ mA}$	f = 2.0 GHz f = 4.0 GHz f = 6.0 GHz		0.9 1.2 1.4	1.4
G _A	Gain @ NF ₀ : $V_{DS} = 2\text{ V}$, $I_{DS} = 25\text{ mA}$	f = 2.0 GHz f = 4.0 GHz f = 6.0 GHz	12.0	16.5 13.0 10.5	
P ₁ dB	Output Power @ 1 dB Gain Compression: $V_{DS} = 4\text{ V}$, $I_{DS} = 70\text{ mA}$	f = 4.0 GHz		20.0	
G ₁ dB	1dB Compressed Gain: $V_{DS} = 4\text{ V}$, $I_{DS} = 70\text{ mA}$	f = 4.0 GHz		12.0	
g _m	Transconductance: $V_{DS} = 2\text{ V}$, $V_{GS} = 0\text{ V}$		70	140	
I _{DSS}	Saturated Drain Current: $V_{DS} = 2\text{ V}$, $V_{GS} = 0\text{ V}$		40	130	200
V _p	Pinchoff Voltage: $V_{DS} = 2\text{ V}$, $I_{DS} = 1\text{ mA}$		-4.0	-1.3	-0.5

Notes: 1. Long leaded 35 Package available upon request.
2. Refer to PACKAGING section "Tape-and-Reel Packaging for Surface Mount Semiconductors".

Absolute Maximum Ratings

Parameter	Symbol	Absolute Maximum ¹
Drain-Source Voltage	V _{DS}	+5 V
Gate-Source Voltage	V _{GS}	-4 V
Drain Current	I _{DS}	I _{DSS}
Total Power Dissipation ^{2,3}	P _T	430 mW
Channel Temperature	T _{CH}	175°C
Storage Temperature ⁴	T _{STG}	-65°C to +175°C

Thermal Resistance: $\theta_{jc} = 350^\circ\text{C/W}$; T_{CH} = 150°C
Liquid Crystal Measurement; 1 μm Spot Size⁵

Notes:

1. Operation of this device above any one of these parameters may cause permanent damage.
2. Case Temperature = 25°C.
3. Derate at 2.9 mW/°C for T_{CASE} > 25°C.
4. Storage above +150°C may tarnish the leads of this package difficult to solder into a circuit. After a device has been soldered into a circuit, it may be safely stored up to 175°C.
5. The small spot size of this technique results in a higher, though more accurate determination of θ_{jc} than do alternate methods. See MEASUREMENTS section for more information.

Part Number Ordering Information

Part Number	Devices Per Reel	Reel Size
ATF-10736-TR1	1000	7"
ATF-10736-TR2	4000	13"
ATF-10736-STR	1	STRIP

Typical Performance, T_A = 25°C

(unless otherwise noted)

INSERTION POWER GAIN, MAXIMUM AVAILABLE GAIN
AND MAXIMUM STABLE GAIN vs. FREQUENCY
V_{DS} = 2 V, I_{DS} = 25 mA

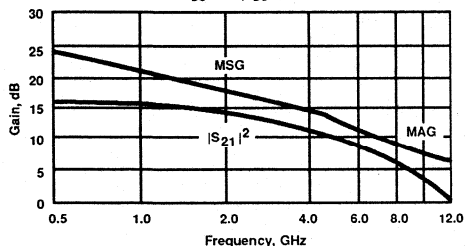

INSERTION POWER GAIN, MAXIMUM AVAILABLE GAIN
AND MAXIMUM STABLE GAIN vs. FREQUENCY
V_{DS} = 4 V, I_{DS} = 70 mA

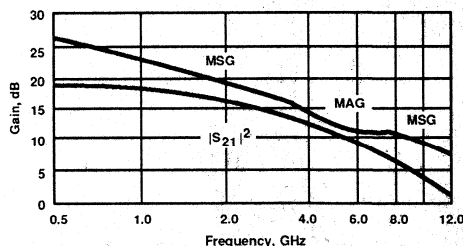

**ATF-10736, 0.5-12 GHz
General Purpose Gallium Arsenide FET**

Typical Scattering Parameters: Common Source, $Z_0 = 50 \Omega$

$T_A = 25^\circ\text{C}$, $V_{DS} = 2 \text{ V}$, $I_{DS} = 25 \text{ mA}$

Freq. GHz	S_{11}		S_{21}			S_{12}			S_{22}	
	Mag	Ang	dB	Mag	Ang	dB	Mag	Ang	Mag	Ang
0.5	.96	-20	15.4	5.90	162	-32.4	.024	77	.50	-10
1.0	.92	-40	15.2	5.77	144	-26.7	.046	66	.48	-21
2.0	.77	-76	13.8	4.92	109	-21.3	.086	52	.39	-34
3.0	.59	-107	12.5	4.20	83	-20.0	.111	40	.33	-45
4.0	.49	-136	11.2	3.64	57	-17.3	.137	24	.26	-61
5.0	.43	-179	10.0	3.15	32	-15.5	.167	9	.14	-65
6.0	.49	138	8.6	2.74	8	-14.9	.179	-5	.05	22
7.0	.57	106	7.3	2.32	-13	-14.8	.183	-18	.19	60
8.0	.68	81	5.6	1.92	-32	-14.7	.185	-33	.33	57
9.0	.73	62	4.2	1.62	-50	-14.8	.183	-40	.42	46
10.0	.77	47	3.0	1.41	-66	-14.8	.182	-52	.46	38
11.0	.82	36	1.0	1.12	-81	-14.6	.186	-67	.50	27
12.0	.85	22	-0.2	0.98	-97	-14.5	.189	-75	.51	15

$T_A = 25^\circ\text{C}$, $V_{DS} = 4 \text{ V}$, $I_{DS} = 70 \text{ mA}$

0.5	.90	-32	19.0	8.95	147	-34.9	.018	77	.40	-7
1.0	.79	-53	18.0	7.96	128	-28.6	.037	70	.38	-17
2.0	.57	-96	15.5	5.99	90	-22.5	.075	56	.34	-38
3.0	.43	-129	13.3	4.60	64	-19.5	.106	43	.31	-50
4.0	.36	-163	11.6	3.78	39	-17.3	.136	31	.28	-51
5.0	.35	156	10.1	3.21	16	-15.6	.166	14	.22	-45
6.0	.47	110	8.8	2.76	-11	-14.5	.189	-5	.15	-4
7.0	.65	78	7.0	2.23	-36	-14.2	.196	-23	.28	35
8.0	.77	58	5.1	1.80	-56	-14.1	.198	-38	.42	37
9.0	.83	44	3.5	1.50	-72	-14.2	.195	-48	.51	33
10.0	.86	30	2.4	1.32	-88	-14.5	.188	-64	.55	26
11.0	.87	16	1.1	1.13	-106	-14.8	.182	-77	.60	18
12.0	.91	1	-0.1	0.99	-123	-15.3	.171	-91	.65	7

A model for this device is available in the DEVICE MODELS section.

Features

- Low Noise Figure: 1.1 dB typical at 12 GHz
- High Associated Gain: 9.5 dB typical at 12 GHz
- High Output Power: 17.5 dBm typical P_{1 dB} at 12 GHz
- Cost Effective Ceramic Microstrip Package
- Tape-and-Reel Packaging Option Available²

Description

Avantek's ATF-13036 is a high performance gallium arsenide Schottky-barrier-gate field effect transistor housed in a cost effective microstrip package. Its premium noise figure makes this device appropriate for use in the first stage of low noise amplifiers operating in the 2-16 GHz frequency range.

This GaAs FET device has a nominal 0.3 micron gate length with a total gate periphery is 250 microns. Proven gold based metallization systems and nitride passivation assure a rugged, reliable device.

Avantek 36 micro-X Package¹

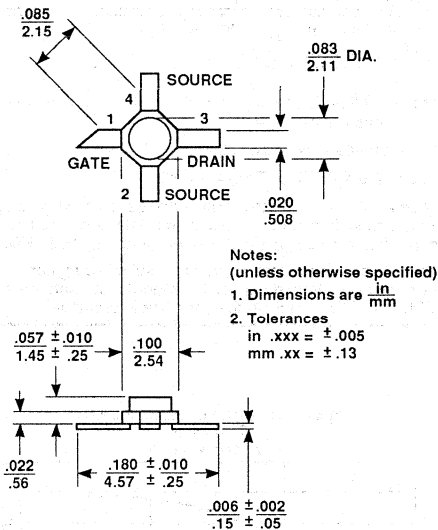

OPTIMUM NOISE FIGURE AND ASSOCIATED GAIN vs. FREQUENCY
V_{DS} = 2.5 V, I_{DS} = 20 mA, T_A = 25°C

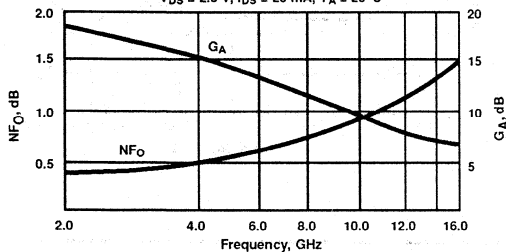

Noise Parameters: V_{DS} = 2.5 V, I_{DS} = 20 mA

Freq. GHz	NF ₀ dB	Gamma Opt Mag	Ang	R _{N/50}
2.0	0.4	.80	29	0.23
4.0	0.5	.54	70	0.22
6.0	0.7	.47	107	0.13
8.0	0.8	.27	164	0.17
12.0	1.1	.33	-55	0.32
14.0	1.3	.42	-12	0.38

Electrical Specifications, T_A = 25°C

Symbol	Parameters and Test Conditions	Units	Min.	Typ.	Max.	
NF ₀	Optimum Noise Figure: V _{DS} = 2.5 V, I _{DS} = 15 - 30 mA	f = 8.0 GHz f = 12.0 GHz f = 14.0 GHz	dB dB dB		0.8 1.1 1.3	1.2
G _A	Gain @ NF ₀ : V _{DS} = 2.5 V, I _{DS} = 15 - 30 mA	f = 8.0 GHz f = 12.0 GHz f = 14.0 GHz	dB dB dB	9.0	11.5 9.5 8.0	
P _{1 dB}	Output Power @ 1 dB Gain Compression: V _{DS} = 4 V, I _{DS} = 40 mA	f = 12.0 GHz	dBm		17.5	
G _{1 dB}	1 dB Compressed Gain: V _{DS} = 4 V, I _{DS} = 40 mA	f = 12.0 GHz	dB		8.5	
g _m	Transconductance: V _{DS} = 2.5 V, V _{GS} = 0 V		mmho	25	55	
I _{DSS}	Saturated Drain Current: V _{DS} = 2.5 V, V _{GS} = 0 V		mA	20	50	100
V _P	Pinchoff Voltage: V _{DS} = 2.5 V, I _{DS} = 1 mA		V	-4.0	-1.5	-0.5

Notes: 1. Long leaded 36 package available upon request.
2. Refer to PACKAGING section "Tape-and-Reel Packaging for Surface Mount Semiconductors".

ATF-13036 2-16 GHz Low Noise Gallium Arsenide FET

Absolute Maximum Ratings

Parameter	Symbol	Absolute Maximum ¹
Drain-Source Voltage	V _{DS}	+5 V
Gate-Source Voltage	V _{GS}	-4 V
Drain Current	I _{DS}	I _{DSS}
Power Dissipation ^{2,3}	P _T	225 mW
Channel Temperature	T _{CH}	175°C
Storage Temperature ⁴	T _{STG}	-65°C to +175°C

Thermal Resistance: $\theta_{JC} = 400^\circ\text{C/W}$; $T_{CH} = 150^\circ\text{C}$
Liquid Crystal Measurement; 1 μm Spot Size⁵

Notes:

- Operation of this device above any one of these parameters may cause permanent damage.
- Case Temperature = 25°C.
- Derate at 2.5 mW/°C for T_{CASE} > 85°C.
- Storage above +150°C may tarnish the leads of this package making it difficult to solder into a circuit. After a device has been soldered into a circuit, it may be safely stored up to 175°C.
- The small spot size of this technique results in a higher, though more accurate determination of θ_{JC} than do alternate methods. See MEASUREMENTS section for more information.

Part Number Ordering Information

Part Number	Devices Per Reel	Reel Size
ATF-13036-TR1	1000	7"
ATF-13036-TR2	4000	13"
ATF-13036-STR	1	STRIP

Typical Performance, T_A = 25°C

(unless otherwise noted)

OPTIMUM NOISE FIGURE AND ASSOCIATED GAIN vs. I_{DS}
f = 12.0 GHz, V_{DS} = 2.5 V

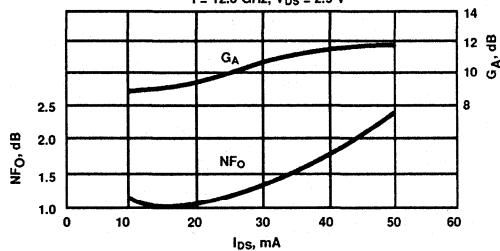

INSERTION POWER GAIN, MAXIMUM AVAILABLE GAIN AND MAXIMUM STABLE GAIN vs. FREQUENCY
V_{DS} = 2.5 V, I_{DS} = 20 mA

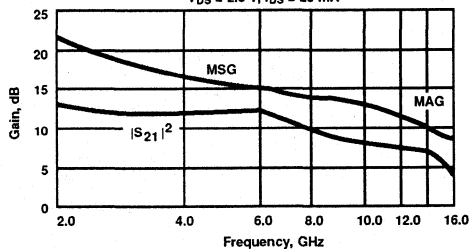

Typical Scattering Parameters: Common Source, Z₀ = 50 Ω

T_A = 25°C, V_{DS} = 2.5 V, I_{DS} = 20 mA

Freq. GHz	S ₁₁		S ₂₁			S ₁₂			S ₂₂	
	Mag	Ang	dB	Mag	Ang	dB	Mag	Ang	Mag	Ang
2.0	.96	-40	12.4	4.19	134	-28.0	.040	67	.56	-20
3.0	.88	-52	11.4	3.72	112	-25.5	.053	58	.58	-27
4.0	.81	-66	11.5	3.77	93	-22.7	.073	50	.55	-34
5.0	.68	-98	12.0	3.99	73	-20.1	.099	31	.43	-54
6.0	.55	-137	11.5	3.75	52	-19.0	.112	14	.30	-80
7.0	.53	-168	11.0	3.53	27	-18.1	.125	0	.21	-103
8.0	.51	161	10.3	3.27	2	-17.1	.139	-11	.14	-135
9.0	.51	120	10.2	3.25	-19	-16.1	.156	-25	.10	163
10.0	.56	84	9.2	2.87	-41	-16.1	.157	-43	.18	110
11.0	.60	50	8.3	2.61	-61	-16.2	.155	-55	.24	87
12.0	.62	44	7.8	2.45	-84	-16.7	.147	-62	.26	64
13.0	.64	36	7.3	2.32	-102	-17.0	.141	-73	.27	46
14.0	.67	16	6.6	2.14	-120	-17.9	.128	-85	.30	20
15.0	.73	-6	5.2	1.83	-139	-19.2	.110	-97	.36	-4
16.0	.77	-22	4.2	1.62	-157	-20.6	.093	-112	.39	-14

A model for this device is available in the DEVICE MODELS section.

Features

- **Low Noise Figure: 1.1 dB typical at 12 GHz**
- **High Associated Gain: 9.5 dB typical at 12 GHz**
- **High Output Power: 17.5 dBm typical P_{1dB} at 12 GHz**

Description

Avantek's ATF-13100 is a high performance gallium arsenide Schottky-barrier-gate field effect transistor chip. This device is designed for use in low noise, wideband amplifier and oscillator applications in the 2-18 GHz frequency range.

This GaAs FET device has a nominal 0.3 micron gate length with a total gate periphery of 250 microns. Proven gold based metalization systems and nitride passivation assure a rugged, reliable device.

The recommended mounting procedure is to die attach at a stage temperature of 300°C using a gold-tin preform under forming gas. Assembly can be preformed with either wedge or ball bonding using 0.7 mil gold wire. See also "Chip Use" in the APPLICATIONS section.

Avantek Chip Outline

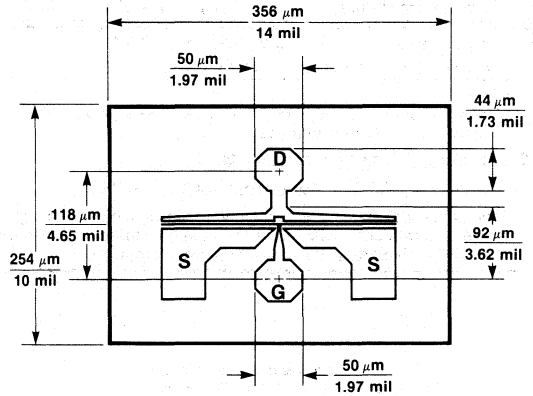

OPTIMUM NOISE FIGURE AND ASSOCIATED GAIN vs. FREQUENCY
 T_A = 25°C, V_{DS} = 2.5 V, I_{DS} = 20 mA

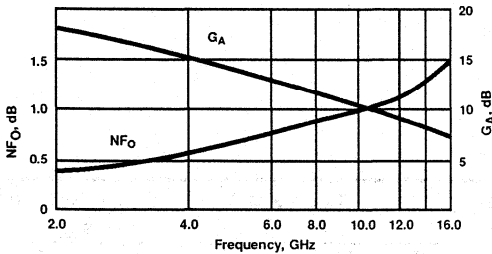

Noise Parameters: V_{DS} = 2.5 V, I_{DS} = 20 mA

Freq. GHz	NF ₀ dB	Gamma Opt Mag	Ang	R _N /50
4.0	0.5	.60	30	.32
6.0	0.7	.32	68	.21
8.0	0.8	.25	102	.15
12.0	1.1	.23	-165	.09
15.0	1.5	.32	-112	.21

Electrical Specifications, T_A = 25°C

Symbol	Parameters and Test Conditions ¹	Units	Min.	Typ.	Max.
NF ₀	Optimum Noise Figure: V _{DS} = 2.5 V, I _{DS} = 15 - 30 mA	f = 8.0 GHz f = 12.0 GHz f = 15.0 GHz	dB	0.8	1.2
G _A	Gain @ NF ₀ : V _{DS} = 2.5 V, I _{DS} = 15 - 30 mA	f = 8.0 GHz f = 12.0 GHz f = 15.0 GHz	dB	9.0	12.0
P _{1dB}	Output Power @ 1 dB Gain Compression: V _{DS} = 4 V, I _{DS} = 40 mA	f = 12.0 GHz	dBm	17.5	
G _{1dB}	1 dB Compressed Gain: V _{DS} = 4 V, I _{DS} = 40 mA	f = 12.0 GHz	dB	8.5	
g _m	Transconductance: V _{DS} = 2.5 V, V _{GS} = 0 V		mmho	30	55
I _{DSS}	Saturated Drain Current: V _{DS} = 2.5 V, V _{GS} = 0 V		mA	25	90
V _P	Pinchoff Voltage: V _{DS} = 2.5 V, I _{DS} = 1 mA		V	-3.0	-0.8

Note: 1. RF Performance is determined by assembling and testing 10 samples per wafer.

ATF-13100, 2-18 GHz Low Noise Gallium Arsenide FET

Absolute Maximum Ratings

Parameter	Symbol	Absolute Maximum ¹
Drain-Source Voltage	V _{DS}	+5 V
Gate-Source Voltage	V _{GS}	-4 V
Drain Current	I _{DS}	I _{DSS}
Total Power Dissipation ^{2,3}	P _T	225 mW
Channel Temperature	T _{CH}	175°C
Storage Temperature	T _{STG}	-65°C to +175°C

Thermal Resistance: $\theta_{jc} = 250^\circ\text{C/W}$; T_{CH} = 150°C
Liquid Crystal Measurement; 1 μm Spot Size⁴

Notes:

1. Operation of this device above any one of these parameters may cause permanent damage.
2. Mounting Surface Temperature = 25°C.
3. Derate at 4 mW/°C for T_{MOUNTING SURFACE} > 119°C.
4. The small spot size of this technique results in a higher, though more accurate determination of θ_{jc} than do alternate methods. See MEASUREMENTS section for more information.

Part Number Ordering Information

Part Number	Devices Per Tray
ATF-13100-GP1	5
ATF-13100-GP3	50
ATF-13100-GP6	up to 300

Typical Performance, T_A = 25°C

(unless otherwise noted)

OPTIMUM NOISE FIGURE AND
ASSOCIATED GAIN vs. I_{DS}
f = 12.0 GHz, V_{DS} = 2.5 V

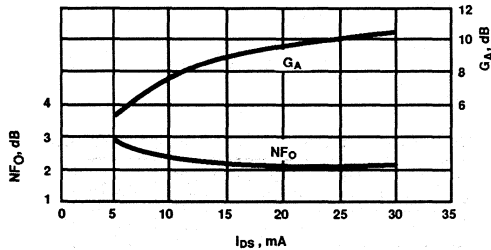

Typical Scattering Parameters: Common Source, Z₀ = 50 Ω

T_A = 25°C, V_{DS} = 2.5 V, I_{DS} = 20 mA

Freq. GHz	S ₁₁		S ₂₁			S ₁₂			S ₂₂	
	Mag	Ang	dB	Mag	Ang	dB	Mag	Ang	Mag	Ang
2.0	.96	-27	13.4	4.68	153	-26.9	.045	75	.55	-16
3.0	.92	-41	13.4	4.65	140	-23.6	.066	67	.52	-24
4.0	.85	-58	13.1	4.54	126	-21.4	.085	59	.49	-33
5.0	.79	-76	12.9	4.40	113	-19.8	.102	50	.44	-41
6.0	.73	-95	12.4	4.19	100	-18.7	.116	42	.38	-48
7.0	.68	-113	12.0	3.97	87	-18.0	.126	34	.30	-54
8.0	.63	-132	11.4	3.71	75	-17.5	.134	25	.24	-64
9.0	.62	-151	10.9	3.51	63	-17.1	.140	18	.18	-75
10.0	.59	-167	10.3	3.27	53	-16.8	.144	11	.13	-84
11.0	.59	173	9.7	3.07	40	-16.5	.149	2	.08	-104
12.0	.57	155	9.0	2.83	30	-16.5	.150	-9	.02	160
13.0	.60	136	8.6	2.69	19	-16.4	.151	-16	.08	106
14.0	.64	116	7.9	2.47	7	-16.4	.151	-25	.15	103
15.0	.67	98	7.1	2.26	-6	-16.4	.152	-34	.23	100
16.0	.73	83	5.8	1.96	-16	-16.9	.143	-40	.31	90
17.0	.77	72	4.6	1.70	-26	-17.0	.141	-45	.36	82
18.0	.80	63	3.5	1.50	-35	-17.4	.135	-48	.40	72

A model for this device is available in the DEVICE MODELS section.

Features

- Low Noise Figure: 1.2 dB typical at 12 GHz
- High Associated Gain: 9.5 dB typical at 12 GHz
- High Output Power: 17.5 dBm typical P_{1 dB} at 12 GHz
- Cost Effective Ceramic Microstrip Package
- Tape-and-Reel Packaging Option Available²

Description

Avantek's ATF-13136 is a high performance gallium arsenide Schottky-barrier-gate field effect transistor housed in a cost effective microstrip package. Its premium noise figure makes this device appropriate for use in the first stage of low noise amplifiers operating in the 2-16 GHz frequency range.

This GaAs FET device has a nominal 0.3 micron gate length with a total gate periphery of 250 microns. Proven gold based metallization systems and nitride passivation assure a rugged, reliable device.

Avantek 36 micro-X Package¹

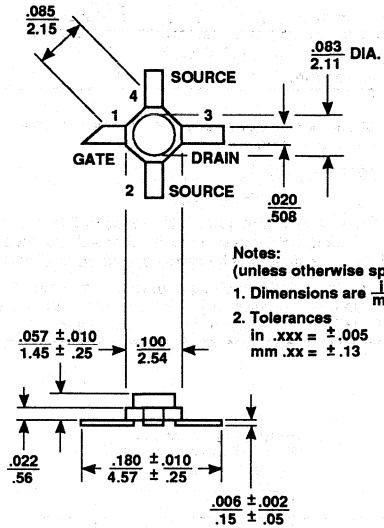

OPTIMUM NOISE FIGURE AND ASSOCIATED GAIN vs. FREQUENCY
V_{DS} = 2.5 V, I_{DS} = 20 mA, T_A = 25°C

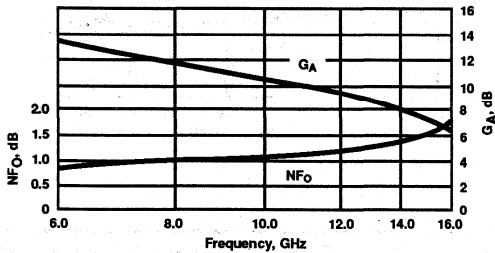

Noise Parameters: V_{DS} = 3 V, I_{DS} = 20 mA

Freq. GHz	NF ₀ dB	Gamma Mag	Opt Ang	R _N /50
4.0	0.5	.58	87	.22
6.0	0.8	.47	130	.18
8.0	1.0	.37	-163	.17
12.0	1.2	.47	-65	.80
14.0	1.4	.52	-15	1.20

Electrical Specifications, T_A = 25°C

Symbol	Parameters and Test Conditions	Units	Min.	Typ.	Max.
NF ₀	Optimum Noise Figure: V _{DS} = 2.5 V, I _{DS} = 15 - 30 mA	f = 8.0 GHz f = 12.0 GHz f = 14.0 GHz	dB		1.0 1.2 1.4
GA	Gain @ NF ₀ : V _{DS} = 2.5 V, I _{DS} = 15 - 30 mA	f = 8.0 GHz f = 12.0 GHz f = 14.0 GHz	dB	8.5	11.5 9.5 8.0
P _{1 dB}	Output Power @ 1 dB Gain Compression: V _{DS} = 4 V, I _{DS} = 40 mA	f = 12.0 GHz	dBm		17.5
G _{1 dB}	1dB Compressed Gain: V _{DS} = 4 V, I _{DS} = 40 mA	f = 12.0 GHz	dB		8.5
g _m	Transconductance: V _{DS} = 2.5 V, V _{GS} = 0 V		mmho	25	55
I _{DSS}	Saturated Drain Current: V _{DS} = 2.5 V, V _{GS} = 0 V		mA	20	50
V _P	Pinchoff Voltage: V _{DS} = 2.5 V, I _{DS} = 1 mA		V	-4.0	-1.5

Notes: 1. Long leaded 35 package available upon request.
2. Refer to PACKAGING section "Tape-and-Reel Packaging for Surface Mount Semiconductors".

ATF-13136, 2-16 GHz Low Noise Gallium Arsenide FET

Absolute Maximum Ratings

Parameter	Symbol	Absolute Maximum ¹
Drain-Source Voltage	V _{DS}	+5 V
Gate-Source Voltage	V _{GS}	-4 V
Drain Current	I _{DS}	I _{DSS}
Power Dissipation ^{2,3}	P _T	225 mW
Channel Temperature	T _{CH}	175°C
Storage Temperature ⁴	T _{STG}	-65°C to +175°C

Thermal Resistance: $\theta_{JC} = 400^\circ\text{C/W}$; T_{CH} = 150°C
Liquid Crystal Measurement; 1 μm Spot Size⁵

Notes:

- Operation of this device above any one of these parameters may cause permanent damage.
- Case Temperature = 25°C.
- Derate at 2.5 mW/°C for T_{CASE} > 85°C.
- Storage above +150°C may tarnish the leads of this package making it difficult to solder into a circuit. After a device has been soldered into a circuit, it may be safely stored up to 175°C.
- The small spot size of this technique results in a higher, though more accurate determination of θ_{JC} than do alternate methods. See MEASUREMENTS section for more information.

Part Number Ordering Information

Part Number	Devices Per Reel	Reel Size
ATF-13136-TR1	1000	7"
ATF-13136-TR2	4000	13"
ATF-13136-STR	1	STRIP

Typical Performance, T_A = 25°C

(unless otherwise noted)

OPTIMUM NOISE FIGURE AND ASSOCIATED GAIN vs. I_{DS}
V_{DS} = 2.5 V, f = 12.0 GHz

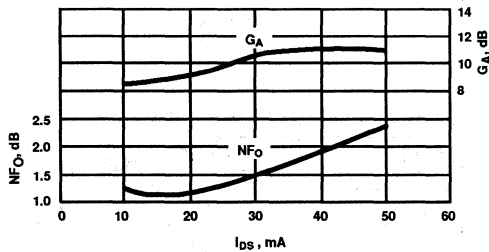

INSERTION POWER GAIN, MAXIMUM AVAILABLE GAIN AND MAXIMUM STABLE GAIN vs. FREQUENCY
V_{DS} = 2.5 V, I_{DS} = 20 mA

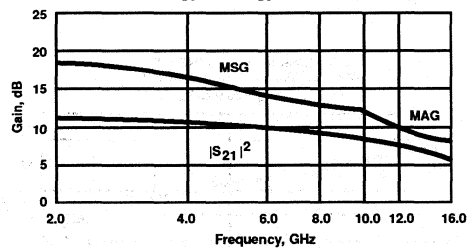

Typical Scattering Parameters: Common Source, Z₀ = 50 Ω

T_A = 25°C, V_{DS} = 2.5 V, I_{DS} = 20 mA

Freq. GHz	S ₁₁		S ₂₁			S ₁₂			S ₂₂	
	Mag	Ang	dB	Mag	Ang	dB	Mag	Ang	Mag	Ang
2.0	.95	-42	11.2	3.65	134	-26.7	.046	62	.56	-37
3.0	.87	-65	10.7	3.43	112	-24.2	.062	40	.53	-47
4.0	.84	-85	10.3	3.28	93	-22.3	.077	31	.53	-54
5.0	.78	-104	10.1	3.21	73	-20.3	.097	18	.48	-62
6.0	.69	-128	10.4	3.30	52	-18.6	.117	7	.43	-76
7.0	.59	-163	10.4	3.32	27	-17.3	.137	-12	.35	-95
8.0	.54	157	9.8	3.10	2	-17.0	.142	-27	.26	-110
9.0	.55	121	9.2	2.89	-19	-16.3	.153	-43	.15	-119
10.0	.54	93	8.7	2.71	-41	-16.0	.159	-58	.07	-142
11.0	.56	64	8.1	2.54	-61	-16.2	.155	-73	.06	92
12.0	.61	37	7.4	2.34	-84	-16.8	.144	-89	.15	46
13.0	.65	19	6.8	2.18	-102	-17.6	.132	-100	.18	23
14.0	.65	7	6.4	2.09	-120	-18.0	.126	-114	.19	-2
15.0	.67	-6	5.9	1.98	-139	-18.2	.123	-119	.16	-27
16.0	.68	-25	5.3	1.84	-170	-18.4	.120	-134	.13	-30

A model for this device is available in the DEVICE MODELS section.

Features

- **Low Noise Figure: 1.0 dB typical at 12 GHz**
- **High Associated Gain: 10.0 dB typical at 12 GHz**
- **High Output Power: 17.5 dBm typical P_{1 dB} at 12 GHz**
- **Hermetic Gold-Ceramic Microstrip Package**

Description

Avantek's ATF-13170 is a high performance gallium arsenide Schottky-barrier-gate field effect transistor housed in a hermetic, high reliability package. Its premium noise figure makes this device appropriate for use in low noise amplifiers operating in the 2-16 GHz frequency range.

This GaAs FET device has a nominal 0.3 micron gate length with a total gate periphery of 250 microns. Proven gold based metallization systems and nitride passivation assure a rugged, reliable device.

Avantek 70 mil Package

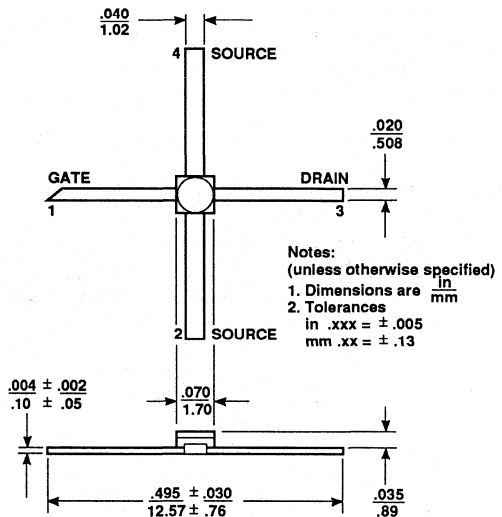

OPTIMUM NOISE FIGURE AND ASSOCIATED GAIN vs. FREQUENCY
 T_A = 25°C, V_{DS} = 2.5 V, I_{DS} = 20 mA

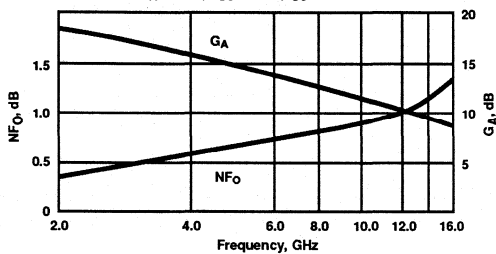

Noise Parameters: V_{DS} = 3 V, I_{DS} = 20 mA

Freq. GHz	NF ₀ dB	Gamma Opt Mag	Ang	R _N /50
4.0	0.5	.62	56	.44
6.0	0.7	.47	81	.34
8.0	0.8	.53	116	.19
12.0	1.0	.44	157	.12
14.0	1.3	.43	179	.07

Electrical Specifications, T_A = 25°C

Symbol	Parameters and Test Conditions	Units	Min.	Typ.	Max.
NF ₀	Optimum Noise Figure: V _{DS} = 2.5 V, I _{DS} = 20 mA	f = 8.0 GHz f = 12.0 GHz f = 14.0 GHz		0.8 1.0 1.3	1.1
G _A	Gain @ NF ₀ : V _{DS} = 2.5 V, I _{DS} = 20 mA	f = 8.0 GHz f = 12.0 GHz f = 14.0 GHz	9.0	12.0 10.0 8.5	
P _{1 dB}	Output Power @ 1 dB Gain Compression: V _{DS} = 4 V, I _{DS} = 40 mA	f = 12.0 GHz		17.5	
G _{1 dB}	1 dB Compressed Gain: V _{DS} = 4 V, I _{DS} = 40 mA	f = 12.0 GHz		8.5	
g _m	Transconductance: V _{DS} = 2.5 V, V _{GS} = 0 V		30	55	
I _{DS}	Saturated Drain Current: V _{DS} = 2.5 V, V _{GS} = 0 V		25	50	90
V _p	Pinchoff Voltage: V _{DS} = 2.5 V, I _{DS} = 1 mA		-3.0	-1.5	-0.8

ATF-13170, 2-16 GHz Low Noise Gallium Arsenide FET

Absolute Maximum Ratings

Parameter	Symbol	Absolute Maximum ¹
Drain-Source Voltage	V _{DS}	+5 V
Gate-Source Voltage	V _{GS}	-4 V
Drain Current	I _{DS}	I _{DSS}
Power Dissipation ^{2,3}	P _T	225 mW
Channel Temperature	T _{CH}	175°C
Storage Temperature	T _{STG}	-65°C to +175°C

Thermal Resistance: $\theta_{jc} = 350^\circ\text{C/W}$; $T_{CH} = 150^\circ\text{C}$
Liquid Crystal Measurement; 1 μm Spot Size⁴

Notes:

- Operation of this device above any one of these parameters may cause permanent damage.
- Case Temperature = 25°C.
- Derate at 2.9 mW/°C for T_{CASE} > 96°C.
- The small spot size of this technique results in a higher, though more accurate determination of θ_{jc} than do alternate methods. See MEASUREMENTS section for more information.

Typical Performance, T_A = 25°C

(unless otherwise noted)

OPTIMUM NOISE FIGURE AND ASSOCIATED GAIN vs. I_{DS} AND V_{DS}
V_{DS} = 2.5 V, f = 12.0 GHz

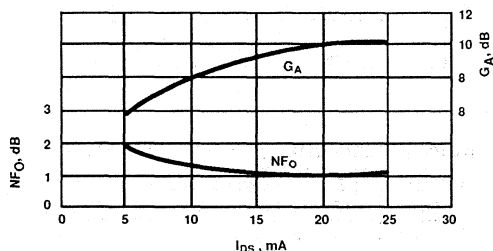

INSERTION POWER GAIN, MAXIMUM AVAILABLE GAIN AND MAXIMUM STABLE GAIN vs. FREQUENCY
V_{DS} = 2.5 V, I_{DS} = 20 mA

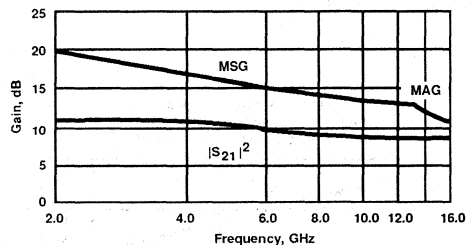

Typical Scattering Parameters: Common Source, Z₀ = 50 Ω

T_A = 25°C, V_{DS} = 2.5 V, I_{DS} = 20 mA

Freq. GHz	S ₁₁		S ₂₁			S ₁₂			S ₂₂	
	Mag	Ang	dB	Mag	Ang	dB	Mag	Ang	Mag	Ang
2.0	.97	-36	11.4	3.73	143	-28.4	.038	65	.48	-28
3.0	.94	-51	11.2	3.63	128	-25.3	.054	55	.47	-39
4.0	.90	-69	10.9	3.51	111	-23.1	.070	43	.45	-53
5.0	.86	-85	10.5	3.34	94	-21.6	.083	32	.44	-67
6.0	.82	-101	10.1	3.20	78	-20.6	.093	20	.42	-79
7.0	.77	-116	9.7	3.06	63	-19.8	.102	10	.41	-91
8.0	.74	-127	9.3	2.92	50	-19.3	.108	2	.40	-99
9.0	.70	-140	8.9	2.79	37	-18.7	.116	-7	.40	-109
10.0	.67	-153	8.7	2.73	23	-18.2	.123	-17	.41	-120
11.0	.64	-167	8.6	2.69	8	-17.7	.131	-28	.41	-130
12.0	.60	-179	8.4	2.64	-7	-17.2	.137	-39	.40	-139
13.0	.57	-166	8.3	2.59	-21	-16.8	.144	-50	.39	-148
14.0	.53	-153	8.3	2.60	-33	-16.3	.153	-59	.38	-155
15.0	.48	-136	8.3	2.61	-49	-15.6	.166	-73	.37	-167
16.0	.41	-112	8.4	2.62	-67	-14.9	.180	-88	.34	-180
17.0	.36	-79	8.3	2.61	-86	-14.4	.191	-105	.26	-170
18.0	.35	-34	8.2	2.56	-107	-14.0	.200	-124	.17	-170

A model for this device is available in the DEVICE MODELS section.

Features

- Low Noise Figure: 0.7 dB typical at 4 GHz
- High Associated Gain: 15.0 dB typical at 4 GHz
- High Output Power: 18.0 dBm typical P_{1 dB} at 4 GHz
- Low Cost Plastic Package
- Tape-and-Reel Packaging Option Available¹

Description

Avantek's ATF-13284 is a high performance gallium arsenide Schottky-barrier-gate field effect transistor housed in a low cost plastic package. Its low noise figure makes this device appropriate for use in the first or second stages of low noise amplifiers operating in the 1-16 GHz frequency range.

This GaAs FET device has a nominal 0.3 micron gate length with a total gate periphery of 250 microns. Proven gold based metallization systems and nitride passivation assure a rugged, reliable device.

Avantek 84 Plastic Package

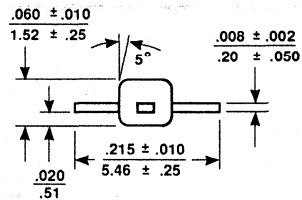
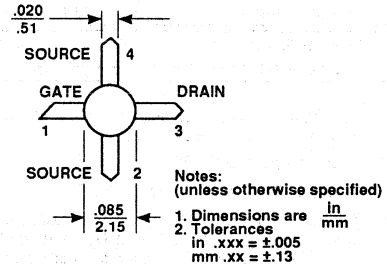

OPTIMUM NOISE FIGURE AND ASSOCIATED GAIN vs. FREQUENCY

T_A = 25°C, V_{DS} = 2.5 V, I_{DS} = 20 mA

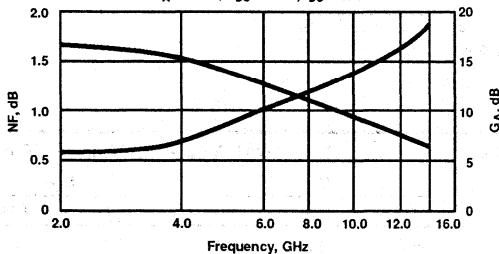

Noise Parameters: V_{DS} = 2.5 V, I_{DS} = 20 mA

Freq. GHz	NF _o dB	Gamma Opt Mag	Ang	R _n /50
1.0	0.6	.92	10	1.3
2.0	0.6	.85	21	1.2
4.0	0.7	.75	54	1.0
8.0	1.2	.57	144	0.3
12.0	1.6	.51	-118	0.1

Electrical Specifications, T_A = 25°C

Symbol	Parameters and Test Conditions	Units	Min.	Typ.	Max.
NF _o	Optimum Noise Figure: V _{DS} = 2.5 V, I _{DS} = 15 - 30 mA	f = 4.0 GHz dB f = 12.0 GHz dB		0.7 1.6	0.8
G _A	Gain @ NF _o : V _{DS} = 2.5 V, I _{DS} = 15 - 30 mA	f = 4.0 GHz dB f = 12.0 GHz dB	13.0	15.0 8.5	
P _{1 dB}	Power Output @ 1 dB Gain Compression: V _{DS} = 4 V, I _{DS} = 40 mA	f = 4.0 GHz dBm		18.0	
G _{1 dB}	1dB Compressed Gain: V _{DS} = 4 V, I _{DS} = 40 mA	f = 4.0 GHz dB		15.0	
g _m	Transconductance: V _{DS} = 2.5 V, V _{GS} = 0 V	mmho	25	55	
I _{DSS}	Saturated Drain Current: V _{DS} = 2.5 V, V _{GS} = 0 V	mA	20	50	100
V _p	Pinchoff Voltage: V _{DS} = 2.5 V, I _{DS} = 1 mA	V	-4.0	-1.5	-0.5

Note: 1. Refer to PACKAGING section "Tape-and-Reel Packaging for Surface Mount Semiconductors".

ATF-13284, 1-16 GHz Low Noise Gallium Arsenide FET

Absolute Maximum Ratings

Parameter	Symbol	Absolute Maximum ¹
Drain-Source Voltage	V _{DS}	+5 V
Gate-Source Voltage	V _{GS}	-4 V
Drain Current	I _{DS}	I _{DSS}
Total Power Dissipation ^{2,3}	P _T	225 mW
Channel Temperature	T _{CH}	175°C
Storage Temperature	T _{STG}	-65°C to +150°C

Thermal Resistance: $\theta_{JC} = 325^\circ\text{C/W}$; $T_{CH} = 150^\circ\text{C}$
Liquid Crystal Measurement: 1 μm Spot Size⁴

Notes:

- Operation of this device above any one of these parameters may cause permanent damage.
- Case Temperature = 25°C.
- Derate at 3.1 mW/°C for T_C > 102°C.
- The small spot size of this technique results in a higher, though more accurate determination of θ_{JC} than do alternate methods. See MEASUREMENTS section for more information.

Part Number Ordering Information

Part Number	Devices Per Reel	Reel Size
ATF-13284-TR1	1000	7"
ATF-13284-TR2	4000	13"
ATF-13284-STR	1	strip

Typical Performance, T_A = 25°C

(unless otherwise noted)

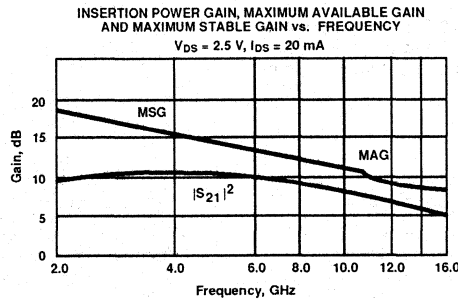

Typical Scattering Parameters: Common Source, Z₀ = 50 Ω

T_A = 25°C, V_{DS} = 2.5 V, I_{DS} = 20 mA

Freq. GHz	S ₁₁		S ₂₁			S ₁₂			S ₂₂	
	Mag	Ang	dB	Mag	Ang	dB	Mag	Ang	Mag	Ang
0.5	.99	-11	10.2	3.22	169	-36.5	.015	80	.50	-11
1.0	.98	-21	10.2	3.24	157	-32.8	.023	74	.50	-17
2.0	.97	-33	10.3	3.26	145	-26.9	.045	67	.50	-24
3.0	.91	-52	10.4	3.30	127	-23.2	.069	55	.49	-37
4.0	.84	-73	10.5	3.36	108	-20.7	.092	42	.47	-50
5.0	.77	-91	10.2	3.23	91	-19.3	.109	31	.46	-61
6.0	.70	-108	9.8	3.08	76	-18.3	.121	22	.45	-71
7.0	.64	-123	9.3	2.93	62	-17.6	.132	14	.43	-79
8.0	.59	-142	9.1	2.85	47	-16.9	.153	5	.39	-89
9.0	.54	-166	8.8	2.74	30	-16.3	.153	-5	.33	-104
10.0	.51	168	8.3	2.59	14	-16.0	.159	-15	.25	-123
11.0	.51	147	7.4	2.34	-2	-16.2	.155	-22	.19	-151
12.0	.48	127	7.0	2.25	-12	-16.0	.159	-30	.14	-171
13.0	.51	108	6.7	2.17	-26	-15.9	.161	-35	.12	177
14.0	.57	87	6.1	2.02	-41	-16.0	.160	-46	.12	144
15.0	.59	70	5.6	1.90	-57	-16.1	.158	-53	.15	102
16.0	.62	58	5.1	1.79	-66	-16.1	.157	-59	.21	74
17.0	.63	46	4.6	1.69	-80	-16.1	.157	-67	.28	60
18.0	.64	35	3.7	1.53	-93	-16.1	.157	-84	.36	47

Features

- Low Noise Figure: 1.4 dB typical at 12 GHz
- High Associated Gain: 9.0 dB typical at 12 GHz
- High Output Power: 17.5 dBm typical P_{1 dB} at 12 GHz
- Cost Effective Ceramic Microstrip Package
- Tape-and-Reel Packaging Option Available²

Description

Avantek's ATF-13336 is a high performance gallium arsenide Schottky-barrier-gate field effect transistor housed in a cost effective microstrip package. Its premium noise figure makes this device appropriate for use in the second stage of low noise amplifiers operating in the 2-16 GHz frequency range.

This GaAs FET device has a nominal 0.3 micron gate length with a total gate periphery of 250 microns. Proven gold based metallization systems and nitride passivation assure a rugged, reliable device.

Avantek 36 micro-X Package¹

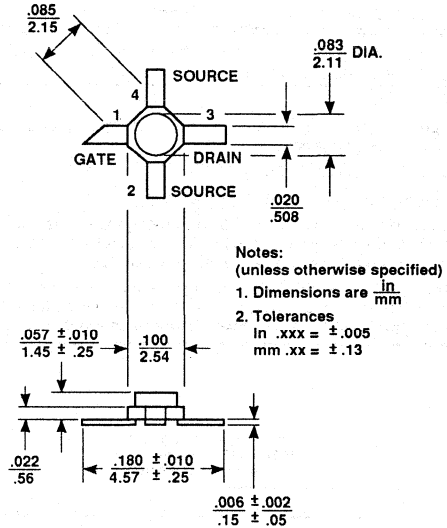

OPTIMUM NOISE FIGURE AND ASSOCIATED GAIN vs. FREQUENCY
V_{DS} = 2.5 V, I_{DS} = 20 mA, T_A = 25°C

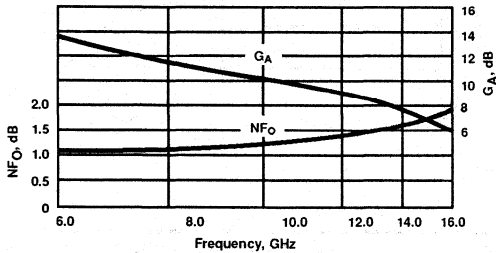

Noise Parameters: V_{DS} = 2.5 V, I_{DS} = 20 mA

Freq. GHz	NF ₀ dB	Gamma Opt Mag	Ang	R _N /50
4.0	0.8	.63	93	.27
6.0	1.1	.47	138	.10
8.0	1.2	.40	-153	.20
12.0	1.4	.52	-45	.88
14.0	1.6	.57	-2	1.3

Electrical Specifications, T_A = 25°C

Symbol	Parameters and Test Conditions	Units	Min.	Typ.	Max.
NF ₀	Optimum Noise Figure: V _{DS} = 2.5 V, I _{DS} = 15 - 30 mA	f = 8.0 GHz f = 12.0 GHz f = 14.0 GHz	dB		1.2 1.4 1.6
GA	Gain @ NF ₀ : V _{DS} = 2.5 V, I _{DS} = 15 - 30 mA	f = 8.0 GHz f = 12.0 GHz f = 14.0 GHz	dB	8.0	11.5 9.0 7.5
P _{1 dB}	Output Power @ 1 dB Gain Compression: V _{DS} = 4 V, I _{DS} = 40 mA	f = 12.0 GHz	dBm		17.5
G _{1 dB}	1 dB Compressed Gain: V _{DS} = 4 V, I _{DS} = 40 mA	f = 12.0 GHz	dB		8.5
g _m	Transconductance: V _{DS} = 2.5 V, V _{GS} = 0 V		mmho	25	55
I _{DSS}	Saturated Drain Current: V _{DS} = 2.5 V, V _{GS} = 0 V		mA	20	50 100
V _P	Pinchoff Voltage: V _{DS} = 2.5 V, I _{DS} = 1 mA		V	-4.0	-1.5 -0.5

Notes: 1. Long leaded 35 Package available upon request.
2. Refer to PACKAGING section "Tape-and-Reel Packaging for Surface Mount Semiconductors".

ATF-13336, 2-16 GHz
Low Noise Gallium Arsenide FET

Absolute Maximum Ratings

Parameter	Symbol	Absolute Maximum ¹
Drain-Source Voltage	V _{DS}	+5 V
Gate-Source Voltage	V _{GS}	-4 V
Drain Current	I _{DS}	I _{DSS}
Power Dissipation ^{2,3}	P _T	225 mW
Channel Temperature	T _{CH}	175°C
Storage Temperature ⁴	T _{STG}	-65°C to +175°C

Thermal Resistance: $\theta_{jC} = 400^\circ\text{C/W}$; T_{CH} = 150°C
 Liquid Crystal Measurement; 1 μm Spot Size⁵

Notes:

1. Operation of this device above any one of these parameters may cause permanent damage.
2. Case Temperature = 25°C.
3. Derate at 2.5 mW/°C for T_{CASE} > 85°C.
4. Storage above +150°C may tarnish the leads of this package difficult to solder into a circuit. After a device has been soldered into a circuit, it may be safely stored up to 175°C.
5. The small spot size of this technique results in a higher, though more accurate determination of θ_{jC} than do alternate methods. See MEASUREMENTS section for more information.

Part Number Ordering Information

Part Number	Devices Per Reel	Reel Size
ATF-13336-TR1	1000	7"
ATF-13336-TR2	4000	13"
ATF-13336-STR	1	STRIP

Typical Performance, T_A = 25°C

(unless otherwise noted)

OPTIMUM NOISE FIGURE AND ASSOCIATED GAIN vs. I_{DS}
 V_{DS} = 2.5 V, f = 12.0 GHz

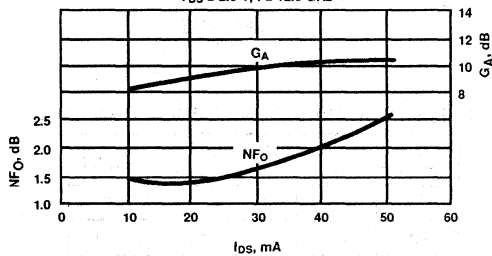

INSERTION POWER GAIN, MAXIMUM AVAILABLE GAIN AND MAXIMUM STABLE GAIN vs. FREQUENCY
 V_{DS} = 2.5 V, I_{DS} = 20 mA

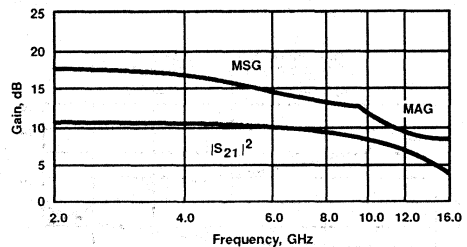

Typical Scattering Parameters: Common Source, Z₀ = 50 Ω

T_A = 25°C, V_{DS} = 2.5 V, I_{DS} = 20 mA

Freq. GHz	S ₁₁		S ₂₁			S ₁₂			S ₂₂	
	Mag	Ang	dB	Mag	Ang	dB	Mag	Ang	Mag	Ang
2.0	.96	-51	10.6	3.39	127	-27.1	.044	57	.61	-41
3.0	.88	-75	10.3	3.28	106	-23.4	.060	33	.58	-51
4.0	.86	-96	10.1	3.19	86	-22.6	.074	25	.57	-57
5.0	.79	-117	9.9	3.13	66	-20.6	.093	12	.54	-65
6.0	.69	-142	10.2	3.22	46	-18.9	.114	1	.49	-79
7.0	.60	-178	10.1	3.21	21	-17.6	.132	-18	.42	-97
8.0	.54	141	9.8	3.10	-4	-17.3	.137	-33	.31	-112
9.0	.56	103	8.9	2.80	-26	-16.7	.147	-48	.21	-121
10.0	.56	74	8.3	2.60	-48	-16.5	.150	-63	.09	-145
11.0	.58	44	7.6	2.39	-68	-16.8	.145	-78	.07	89
12.0	.63	20	6.7	2.17	-90	-17.5	.133	-95	.16	43
13.0	.65	3	6.0	2.00	-108	-18.3	.121	-107	.19	21
14.0	.66	-7	5.5	1.89	-126	-18.9	.114	-121	.19	-4
15.0	.70	-19	4.9	1.76	-144	-19.0	.112	-129	.16	-28
16.0	.72	-34	4.4	1.66	-175	-19.2	.110	-142	.14	-32

A model for this device is available in the DEVICE MODELS section.

Features

- Low Noise Figure: 1.0 dB typical at 4 GHz
- High Associated Gain: 14.0 dB typical at 4 GHz
- High Output Power: 18.0 dBm typical P₁ dB at 4 GHz
- Low Cost Plastic Package
- Tape-and-Reel Packaging Option Available¹

Description

Avantek's ATF-13484 is a high performance gallium arsenide Schottky-barrier-gate field effect transistor housed in a low cost plastic package. Its low noise figure makes this device appropriate for use in the first or second stages of low noise amplifiers operating in the 1-16 GHz frequency range.

This GaAs FET device has a nominal 0.3 micron gate length with a total gate periphery of 250 microns. Proven gold based metallization systems and nitride passivation assure a rugged, reliable device.

Avantek 84 Plastic Package

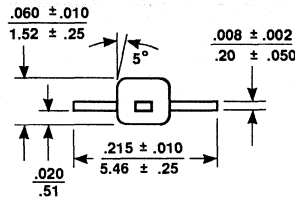
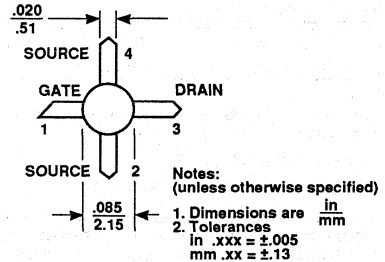

OPTIMUM NOISE FIGURE AND ASSOCIATED GAIN vs. FREQUENCY

T_A = 25°C, V_{DS} = 2.5 V, I_{DS} = 20 mA

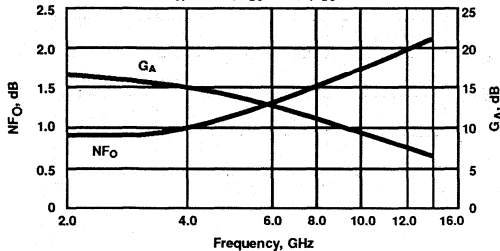

Noise Parameters: V_{DS} = 2.5 V, I_{DS} = 20 mA

Freq. GHz	NF ₀ dB	Gamma Mag	Opt Ang	R _n /50
1.0	0.8	.92	14	1.3
2.0	0.8	.85	28	1.1
4.0	1.0	.76	61	0.9
8.0	1.5	.60	152	0.2
12.0	2.0	.55	-104	0.2

Electrical Specifications, T_A = 25°C

Symbol	Parameters and Test Conditions	Units	Min.	Typ.	Max.
NF ₀	Optimum Noise Figure: V _{DS} = 2.5 V, I _{DS} = 15 - 30 mA	f = 4.0 GHz dB f = 12.0 GHz dB		1.0 2.0	1.2
G _A	Gain @ NF ₀ : V _{DS} = 2.5 V, I _{DS} = 15 - 30 mA	f = 4.0 GHz dB f = 12.0 GHz dB	12.0	14.0 7.5	
P ₁ dB	Output Power @ 1 dB Gain Compression: V _{DS} = 4 V, I _{DS} = 40 mA	f = 4.0 GHz		18.0	
G ₁ dB	1dB Compressed Gain: V _{DS} = 4 V, I _{DS} = 40 mA	f = 4.0 GHz		14.5	
g _m	Transconductance: V _{DS} = 2.5 V, V _{GS} = 0 V	mmho	25	55	
I _{DS}	Saturated Drain Current: V _{DS} = 2.5 V, V _{GS} = 0 V	mA	20	50	100
V _P	Pinchoff Voltage: V _{DS} = 2.5 V, I _{DS} = 1 mA	V	-4.0	-1.5	-0.5

Note: 1. Refer to PACKAGING section "Tape-and-Reel Packaging for Surface Mount Semiconductors".

ATF-13484, 1-16 GHz
Low Noise Gallium Arsenide FET

Absolute Maximum Ratings

Parameter	Symbol	Absolute Maximum ¹
Drain-Source Voltage	V _{DS}	+5 V
Gate-Source Voltage	V _{GS}	-4 V
Drain Current	I _{DS}	I _{DSS}
Total Power Dissipation ^{2,3}	P _T	225 mW
Channel Temperature	T _{CH}	175°C
Storage Temperature	T _{STG}	-65°C to +150°C

Thermal Resistance: $\theta_{JC} = 325^\circ\text{C/W}$; $T_{CH} = 150^\circ\text{C}$
 Liquid Crystal Measurement: 1 μm Spot Size⁴

Notes:

1. Operation of this device above any one of these parameters may cause permanent damage.
2. Case Temperature = 25°C.
3. Derate at 3.1 mW/°C for T_C > 102°C.
4. The small spot size of this technique results in a higher, though more accurate determination of θ_{JC} than do alternate methods. See MEASUREMENTS section for more information.

Part Number Ordering Information

Part Number	Devices Per Reel	Reel Size
ATF-13484-TR1	1000	7"
ATF-13484-TR2	4000	13"
ATF-13484-STR	1	strip

Typical Performance, T_A = 25°C

(unless otherwise noted)

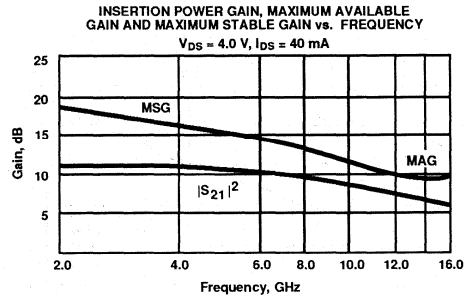
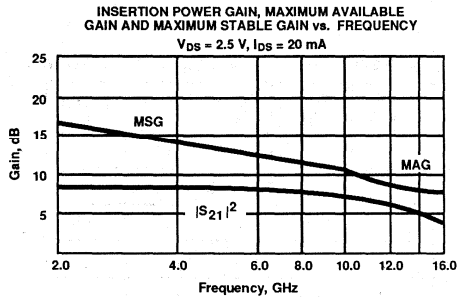

**ATF-13484, 1-16 GHz
Low Noise Gallium Arsenide FET**

Typical Scattering Parameters: Common Source, $Z_0 = 50 \Omega$

$T_A = 25^\circ\text{C}$, $V_{DS} = 2.5 \text{ V}$, $I_{DS} = 20 \text{ mA}$

Freq. GHz	S_{11}		S_{21}			S_{12}			S_{22}	
	Mag	Ang	dB	Mag	Ang	dB	Mag	Ang	Mag	Ang
0.5	.99	-12	8.9	2.79	170	-37.1	.014	81	.50	-10
1.0	.99	-22	8.5	2.67	158	-32.4	.024	78	.50	-18
2.0	.97	-35	8.2	2.56	143	-26.2	.049	63	.50	-26
3.0	.92	-53	8.4	2.64	126	-23.1	.070	51	.49	-38
4.0	.87	-73	8.5	2.66	107	-20.4	.095	38	.45	-55
5.0	.80	-91	8.4	2.62	90	-18.9	.113	28	.41	-69
6.0	.75	-109	8.2	2.57	74	-17.3	.136	16	.38	-81
7.0	.69	-127	8.0	2.52	57	-16.6	.148	5	.34	-91
8.0	.64	-148	7.7	2.43	41	-15.7	.164	-5	.31	-102
9.0	.61	-173	7.4	2.35	23	-15.4	.169	-14	.25	-117
10.0	.58	163	6.8	2.20	6	-15.4	.170	-28	.20	-134
11.0	.57	140	6.2	2.03	-11	-15.3	.172	-38	.16	-165
12.0	.56	119	5.8	1.95	-23	-15.4	.170	-49	.11	161
13.0	.60	97	5.6	1.90	-41	-15.5	.168	-59	.09	121
14.0	.64	79	5.3	1.84	-56	-15.6	.166	-75	.12	74
15.0	.67	66	4.6	1.70	-69	-15.7	.164	-79	.17	52
16.0	.71	49	3.9	1.57	-81	-15.8	.162	-82	.22	30
17.0	.73	38	3.1	1.43	-94	-15.9	.160	-85	.28	20
18.0	.75	27	2.3	1.30	-106	-16.0	.158	-89	.34	14

$T_A = 25^\circ\text{C}$, $V_{DS} = 4.0 \text{ V}$, $I_{DS} = 40 \text{ mA}$

1.0	.98	-19	11.2	3.61	160	-33.2	.022	74	.61	-11
2.0	.94	-40	11.3	3.67	141	-27.1	.044	65	.58	-25
3.0	.88	-59	11.4	3.71	121	-23.4	.068	48	.54	-38
4.0	.80	-80	11.3	3.65	102	-21.6	.083	38	.48	-55
5.0	.72	-99	10.9	3.50	84	-20.2	.098	27	.44	-68
6.0	.65	-118	10.5	3.34	68	-19.1	.111	19	.40	-80
7.0	.59	-137	10.1	3.20	51	-18.1	.124	7	.37	-89
8.0	.54	-159	9.7	3.04	36	-17.3	.136	0	.34	-100
9.0	.52	175	9.1	2.86	19	-17.1	.140	-12	.29	-112
10.0	.50	151	8.5	2.65	2	-16.5	.150	-21	.23	-127
11.0	.50	129	7.7	2.43	-13	-16.4	.152	-31	.17	-150
12.0	.51	108	7.3	2.32	-25	-16.4	.151	-40	.12	-175
13.0	.55	87	7.0	2.25	-42	-16.4	.151	-47	.09	163
14.0	.62	70	6.8	2.20	-56	-16.5	.150	-58	.09	106
15.0	.67	60	6.3	2.06	-66	-16.5	.149	-65	.11	89
16.0	.69	44	5.6	1.90	-81	-16.7	.147	-72	.15	64
17.0	.66	30	4.5	1.68	-95	-16.1	.156	-82	.19	57
18.0	.62	18	3.8	1.55	-112	-15.0	.178	-100	.31	51

Features

- High Associated Gain: 9.0 dB typical at 12 GHz
- High Output Power: 17.5 dBm typical $P_{1\text{ dB}}$ at 12 GHz
- Low Noise Figure: 1.8 dB typical at 12 GHz
- Cost Effective Ceramic Microstrip Package
- Tape-and-Reel Packaging Option Available²

Description

Avantek's ATF-13736 is a high performance gallium arsenide Schottky-barrier-gate field effect transistor housed in a cost effective microstrip package. Its noise figure makes this device appropriate for use in the gain stages of low noise amplifiers operating in the 2-16 GHz frequency range.

This GaAs FET device has a nominal 0.3 micron gate length with a total gate periphery of 250 microns. Proven gold based metallization systems and nitride passivation assure a rugged, reliable device.

Avantek 36 micro-X Package¹

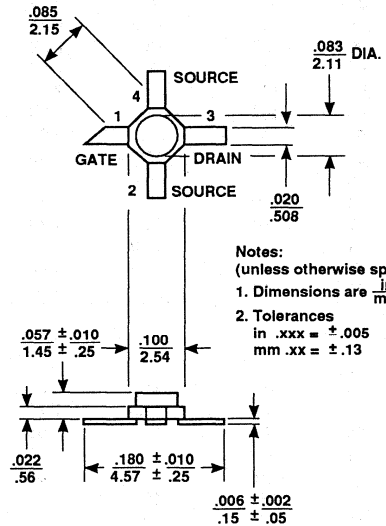

OPTIMUM NOISE FIGURE AND ASSOCIATED GAIN vs. FREQUENCY
 $V_{DS} = 2.5\text{ V}$, $I_{DS} = 20\text{ mA}$, $T_A = 25^\circ\text{C}$

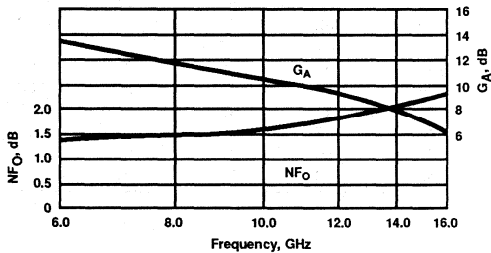

Noise Parameters: $V_{DS} = 3\text{ V}$, $I_{DS} = 20\text{ mA}$

Freq. GHz	NF ₀ dB	Gamma Opt Mag	Opt Ang	R _N /50
4.0	1.1	.71	102	.10
6.0	1.3	.55	147	.07
8.0	1.5	.46	-144	.19
12.0	1.8	.50	-40	.88
14.0	2.1	.52	-2	1.17

Electrical Specifications, $T_A = 25^\circ\text{C}$

Symbol	Parameters and Test Conditions	Units	Min.	Typ.	Max.	
NF ₀	Optimum Noise Figure: $V_{DS} = 2.5\text{ V}$, $I_{DS} = 15 - 30\text{ mA}$	$f = 8.0\text{ GHz}$ $f = 12.0\text{ GHz}$ $f = 14.0\text{ GHz}$	dB		1.5 1.8 2.1	2.2
G _A	Gain @ NF ₀ : $V_{DS} = 2.5\text{ V}$, $I_{DS} = 15 - 30\text{ mA}$	$f = 8.0\text{ GHz}$ $f = 12.0\text{ GHz}$ $f = 14.0\text{ GHz}$	dB	8.0	11.5 9.0 7.0	
P _{1 dB}	Output Power @ 1 dB Gain Compression: $V_{DS} = 4\text{ V}$, $I_{DS} = 40\text{ mA}$	$f = 12.0\text{ GHz}$	dBm		17.5	
G _{1 dB}	1dB Compressed Gain: $V_{DS} = 4\text{ V}$, $I_{DS} = 40\text{ mA}$	$f = 12.0\text{ GHz}$	dB		8.5	
g _m	Transconductance: $V_{DS} = 2.5\text{ V}$, $V_{GS} = 0\text{ V}$		mmho	25	55	
I _{DSS}	Saturated Drain Current: $V_{DS} = 2.5\text{ V}$, $V_{GS} = 0\text{ V}$		mA	20	50	100
V _p	Pinchoff Voltage: $V_{DS} = 2.5\text{ V}$, $I_{DS} = 1\text{ mA}$		V	-4.0	-1.5	-0.5

Notes: 1. Long leaded 35 package available upon request.
 2. Refer to PACKAGING section "Tape-and-Reel Packaging for Surface Mount Semiconductors".

Absolute Maximum Ratings

Parameter	Symbol	Absolute Maximum ¹
Drain-Source Voltage	V _{DS}	+5 V
Gate-Source Voltage	V _{GS}	-4 V
Drain Current	I _{DS}	I _{DSS}
Total Power Dissipation ^{2,3}	P _T	225 mW
Channel Temperature	T _{CH}	175°C
Storage Temperature ⁴	T _{STG}	-65°C to +175°C

Thermal Resistance: $\theta_{jC} = 400^{\circ}\text{C}/\text{W}$; T_{CH} = 150°C
Liquid Crystal Measurement; 1 μm Spot Size⁵

Notes:

1. Operation of this device above any one of these parameters may cause permanent damage.
2. Case Temperature = 25°C.
3. Derate at 2.5 mW/°C for T_{CASE} > 85°C.
4. Storage above +150°C may tarnish the leads of this package making it difficult to solder into a circuit. After a device has been soldered into a circuit, it may be safely stored up to 175°C.
5. The small spot size of this technique results in a higher, though more accurate determination of θ_{jC} than do alternate methods. See MEASUREMENTS section for more information.

Part Number Ordering Information

Part Number	Devices Per Reel	Reel Size
ATF-13736-TR1	1000	7"
ATF-13736-TR2	4000	13"
ATF-13736-STR	1	STRIP

Typical Performance, T_A = 25°C

(unless otherwise noted)

INSERTION POWER GAIN, MAXIMUM AVAILABLE GAIN
AND MAXIMUM STABLE GAIN vs. FREQUENCY
V_{DS} = 2.5 V, I_{DS} = 20 mA

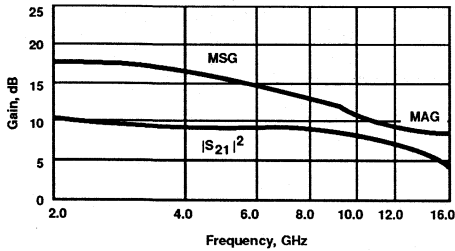

INSERTION POWER GAIN, MAXIMUM AVAILABLE GAIN
AND MAXIMUM STABLE GAIN vs. FREQUENCY
V_{DS} = 4 V, I_{DS} = 40 mA

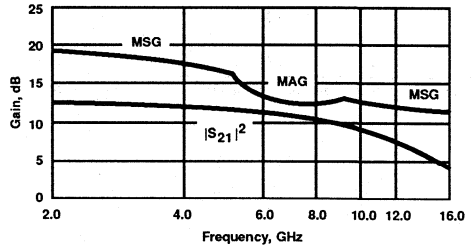

ATF-13736, 2-16 GHz
General Purpose Gallium Arsenide FET

Typical Scattering Parameters: Common Source, $Z_0 = 50 \Omega$

$T_A = 25^\circ\text{C}$, $V_{DS} = 2.5 \text{ V}$, $I_{DS} = 20 \text{ mA}$

Freq. GHz	S_{11}		S_{21}			S_{12}			S_{22}	
	Mag	Ang	dB	Mag	Ang	dB	Mag	Ang	Mag	Ang
2.0	.94	-46	11.0	3.56	128	-26.4	.048	55	.59	-36
3.0	.86	-70	10.2	3.23	109	-25.2	.055	40	.57	-47
4.0	.84	-90	9.8	3.08	91	-23.1	.070	31	.56	-55
5.0	.77	-110	9.6	3.02	69	-20.9	.090	18	.52	-63
6.0	.68	-135	9.9	3.14	51	-19.3	.109	7	.47	-75
7.0	.59	-170	9.9	3.13	24	-18.0	.126	-12	.39	-92
8.0	.54	149	9.5	2.99	-1	-17.6	.132	-27	.30	-112
9.0	.56	112	8.8	2.75	-22	-16.9	.143	-43	.19	-121
10.0	.58	86	8.1	2.53	-43	-16.4	.152	-58	.11	-140
11.0	.60	63	7.6	2.41	-66	-16.5	.149	-73	.09	92
12.0	.64	39	7.0	2.24	-90	-17.1	.140	-81	.15	47
13.0	.68	20	6.4	2.08	-106	-17.6	.132	-90	.19	21
14.0	.70	9	6.0	1.99	-130	-18.0	.126	-97	.19	-3
15.0	.72	-1	5.2	1.83	-145	-18.2	.123	-111	.15	-26
16.0	.74	-17	4.6	1.70	-177	-18.4	.120	-129	.11	-34

$T_A = 25^\circ\text{C}$, $V_{DS} = 4 \text{ V}$, $I_{DS} = 40 \text{ mA}$

2.0	.88	-44	13.5	4.73	130	-26.4	.048	64	.67	-28
3.0	.76	-68	13.0	4.47	107	-24.9	.057	52	.61	-39
4.0	.68	-90	12.4	4.19	86	-22.5	.075	39	.57	-46
5.0	.56	-113	12.0	4.00	66	-21.0	.089	32	.52	-52
6.0	.42	-145	11.8	3.90	44	-19.8	.102	21	.44	-61
7.0	.37	161	11.5	3.74	20	-18.6	.117	9	.31	-75
8.0	.47	116	10.5	3.36	-3	-17.9	.128	-5	.17	-95
9.0	.57	90	9.4	2.96	-23	-17.2	.138	-19	.05	-143
10.0	.63	70	8.9	2.77	-41	-17.4	.135	-28	.06	128
11.0	.69	51	7.9	2.47	-63	-17.7	.131	-39	.17	100
12.0	.77	33	7.1	2.26	-82	-18.0	.126	-52	.26	75
13.0	.82	21	6.0	2.00	-101	-18.6	.118	-65	.35	62
14.0	.85	13	5.4	1.86	-117	-19.2	.110	-75	.39	54
15.0	.83	1	4.8	1.73	-134	-19.7	.104	-83	.41	49
16.0	.81	-17	4.4	1.65	-154	-19.8	.102	-103	.42	41

A model for this device is available in the DEVICE MODELS section.

Features

- **Low Noise Figure: 0.9 dB typical at 4 GHz**
- **High Associated Gain: 13.0 dB typical at 4 GHz**
- **High Output Power: 23.0 dBm typical P_{1 dB} at 4 GHz**

Description

Avantek's ATF-21100 is a high performance gallium arsenide Schottky-barrier-gate field effect transistor chip. This device is designed for use in low noise or medium power amplifier applications in the 0.5-6 GHz frequency range.

This GaAs FET device has a nominal 0.3 micron gate length using airbridge interconnects between drain fingers. Total gate periphery is 750 microns. Proven gold based metallization systems and nitride passivation assure a rugged, reliable device.

The recommended mounting procedure is to die attach at a stage temperature of 300°C using a gold-tin preform under forming gas. Assembly can be performed with either wedge or ball bonding using 0.7 mil gold wire. See also "Chip Use" in the APPLICATIONS section.

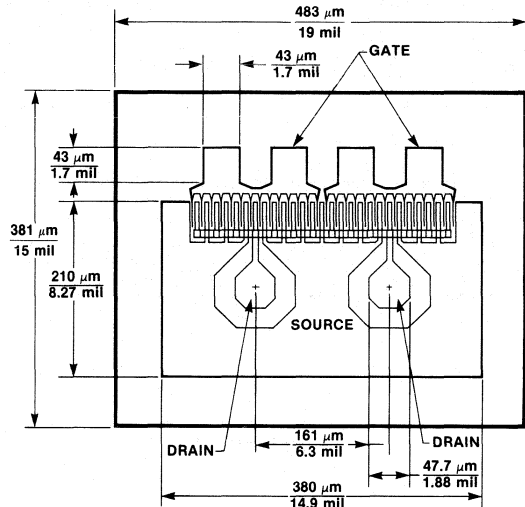
Avantek Chip Outline

Noise Parameters: V_{DS} = 3 V, I_{DS} = 20 mA

Freq. GHz	NF ₀ dB	Gamma Mag	Opt Ang	R _{N/50}
0.5	0.4	.93	10	.92
1.0	0.5	.86	20	.83
2.0	0.6	.72	42	.64
4.0	0.9	.61	104	.28
6.0	1.2	.55	160	.07

Electrical Specifications, T_A = 25°C

Symbol	Parameters and Test Conditions ¹	Units	Min.	Typ.	Max.
NF ₀	Optimum Noise Figure: V _{DS} = 3 V, I _{DS} = 20 mA	f = 2.0 GHz dB f = 4.0 GHz dB f = 6.0 GHz dB		0.6 0.9 1.2	1.1
GA	Gain @ NF ₀ : V _{DS} = 3 V, I _{DS} = 20 mA	f = 2.0 GHz dB f = 4.0 GHz dB f = 6.0 GHz dB	12.0	16.0 13.0 10.0	
P _{1 dB}	Output Power @ 1 dB Gain Compression: V _{DS} = 5 V, I _{DS} = 80 mA	f = 4.0 GHz		23.0	
G _{1 dB}	1 dB Compressed Gain: V _{DS} = 5 V, I _{DS} = 80 mA	f = 4.0 GHz		13.0	
g _m	Transconductance: V _{DS} = 3 V, V _{GS} = 0 V	mmho	70	120	
I _{DSS}	Saturated Drain Current: V _{DS} = 3 V, V _{GS} = 0 V	mA	80	120	200
V _P	Pinchoff Voltage: V _{DS} = 3 V, I _{DS} = 1 mA	V	-3.0	-1.5	-0.8

Note: 1. RF performance is determined by assembling and testing 10 samples per wafer.

ATF-21100, 0.5-6 GHz Low Noise Gallium Arsenide FET

Absolute Maximum Ratings

Parameter	Symbol	Absolute Maximum ¹
Drain Source Voltage	V _{DS}	+7 V
Gate-Source Voltage	V _{GS}	-4 V
Drain Current	I _{DS}	I _{DSS}
Power Dissipation ^{2,3}	PT	600 mW
Channel Temperature	T _{CH}	175°C
Storage Temperature	T _{STG}	-65°C to +175°C

Thermal Resistance: $\theta_{jc} = 150^\circ \text{C/W}$; T_{CH} = 150°C
Liquid Crystal Measurement; 1 μm Spot Size⁴

Notes:

1. Operation of this device above any one of these parameters may cause permanent damage.
2. Mounting Surface Temperature = 25°C.
3. Derate at 6.7 mW/°C for T_{MOUNTING SURFACE} > 85°C.
4. The small spot size of this technique results in a higher, though more accurate determination of θ_{jc} than do alternate methods. See MEASUREMENTS section for more information.

Part Number Ordering Information

Part Number	Devices Per Tray
ATF-21100-GP1	5
ATF-21100-GP3	50
ATF-21100-GP6	up to 300

Typical Performance, T_A = 25°C

(unless otherwise noted)

OPTIMUM NOISE FIGURE AND ASSOCIATED GAIN vs. FREQUENCY
V_{DS} = 3 V, I_{DS} = 20 mA

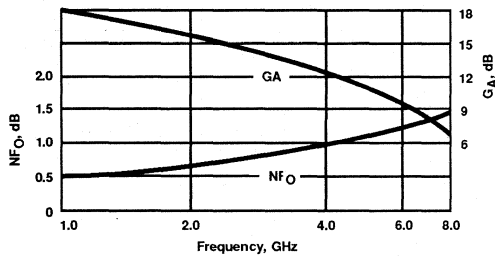

OPTIMUM NOISE FIGURE AND ASSOCIATED GAIN vs. I_{DS}
V_{DS} = 3 V, f = 4.0 GHz

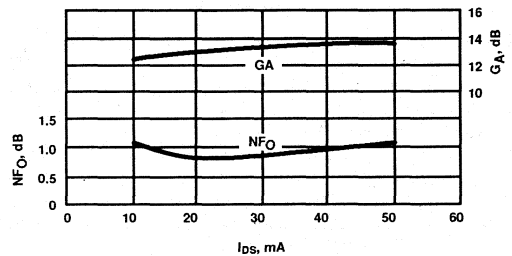

INSERTION POWER GAIN, MAXIMUM AVAILABLE GAIN AND MAXIMUM STABLE GAIN vs. FREQUENCY
V_{DS} = 3 V, I_{DS} = 20 mA

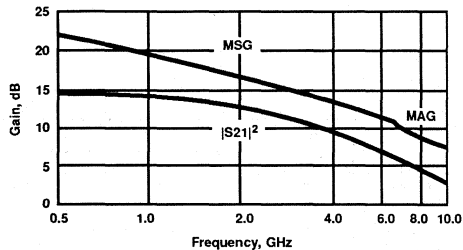

INSERTION POWER GAIN, MAXIMUM AVAILABLE GAIN AND MAXIMUM STABLE GAIN vs. FREQUENCY
V_{DS} = 5 V, I_{DS} = 80 mA

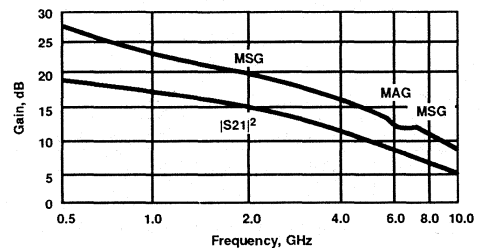

ATF-21100, 0.5-6 GHz
Low Noise Gallium Arsenide FET

Typical Scattering Parameters: Common Source, $Z_0 = 50 \Omega$

$T_A = 25^\circ\text{C}$, $V_{DS} = 3 \text{ V}$, $I_{DS} = 20 \text{ mA}$

Freq. GHz	S_{11}		S_{21}			S_{12}			S_{22}	
	Mag	Ang	dB	Mag	Ang	dB	Mag	Ang	Mag	Ang
0.5	.97	-20	14.0	5.00	166	-30.8	.029	77	.52	-11
1.0	.95	-34	13.7	4.82	152	-24.7	.058	73	.48	-28
2.0	.83	-69	12.6	4.26	130	-20.2	.098	56	.43	-52
3.0	.70	-101	11.1	3.59	105	-18.2	.123	45	.39	-74
4.0	.63	-129	9.5	2.97	88	-17.3	.136	39	.36	-92
5.0	.60	-152	7.9	2.47	74	-17.1	.139	36	.33	-107
6.0	.60	-169	6.4	2.10	62	-17.0	.141	34	.32	-122
7.0	.63	177	5.1	1.81	53	-17.0	.142	33	.33	-134
8.0	.66	167	4.1	1.60	44	-16.8	.145	32	.33	-145
9.0	.68	160	3.1	1.44	36	-16.4	.152	31	.34	-154
10.0	.70	155	2.1	1.32	28	-15.7	.164	27	.33	-166

$T_A = 25^\circ\text{C}$, $V_{DS} = 5 \text{ V}$, $I_{DS} = 80 \text{ mA}$

0.5	.96	-25	18.2	8.10	161	-34.4	.019	80	.50	-9
1.0	.90	-50	17.4	7.41	144	-29.1	.035	71	.46	-17
2.0	.76	-89	15.1	5.72	117	-25.0	.056	62	.37	-26
3.0	.68	-116	13.0	4.48	99	-23.1	.070	60	.31	-32
4.0	.65	-137	11.3	3.66	85	-21.6	.083	61	.26	-38
5.0	.63	-156	9.7	3.06	72	-20.3	.097	61	.23	-49
6.0	.62	-172	8.3	2.61	61	-18.9	.113	62	.20	-65
7.0	.64	175	7.2	2.29	51	-17.8	.129	61	.19	-86
8.0	.66	163	6.2	2.04	41	-16.7	.146	60	.20	-103
9.0	.68	151	5.2	1.82	32	-15.7	.165	57	.22	-119
10.0	.71	139	4.2	1.63	23	-14.7	.184	54	.26	-135

A model for this device is available in the DEVICE MODELS section.

Features

- Low Noise Figure: 0.9 dB typical at 4 GHz
- High Associated Gain: 13.0 dB typical at 4 GHz
- High Output Power: 23.0 dBm typical $P_{1\text{ dB}}$ at 4 GHz
- Hermetic Gold-Ceramic Microstrip Package

Description

Avantek's ATF-21170 is a high performance gallium arsenide Schottky-barrier-gate field effect transistor housed in a hermetic, high reliability package. This device is designed for use in low noise or medium power amplifier applications in the 0.5-6 GHz frequency range.

This GaAs FET device has a nominal 0.3 micron gate length using airbridge interconnects between drain fingers. Total gate periphery is 750 microns. Proven gold based metallization systems and nitride passivation assure a rugged, reliable device.

Avantek 70 mil Package

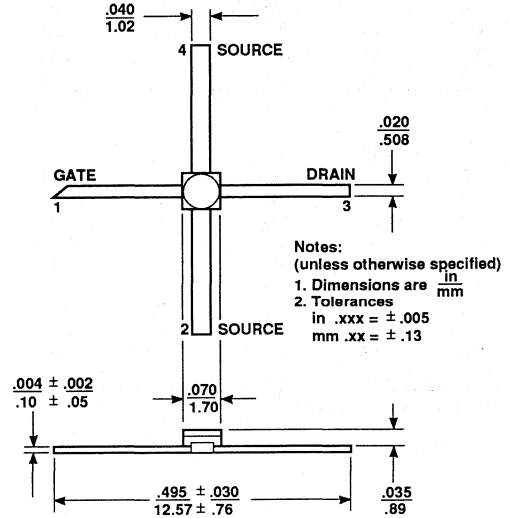

OPTIMUM NOISE FIGURE AND ASSOCIATED GAIN vs. FREQUENCY
 $V_{DS} = 3\text{ V}, I_{DS} = 20\text{ mA}$

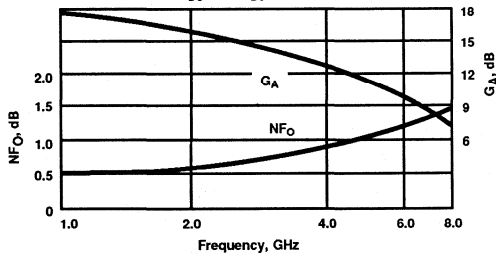

Noise Parameters: $V_{DS} = 3\text{ V}, I_{DS} = 20\text{ mA}$

Freq. GHz	NF ₀ dB	Gamma Opt Mag	Ang	R _{N/50}
0.5	0.4	.93	17	.90
1.0	0.5	.85	35	.70
2.0	0.6	.70	70	.46
4.0	0.9	.59	148	.14
8.0	1.2	.54	-177	.09

Electrical Specifications, $T_A = 25^\circ\text{C}$

Symbol	Parameters and Test Conditions	Units	Min.	Typ.	Max.
NF ₀	Optimum Noise Figure: $V_{DS} = 3\text{ V}, I_{DS} = 20\text{ mA}$	$f = 2.0\text{ GHz}$ $f = 4.0\text{ GHz}$ $f = 6.0\text{ GHz}$	dB		0.6 0.9 1.2
G _A	Gain @ NF ₀ : $V_{DS} = 3\text{ V}, I_{DS} = 20\text{ mA}$	$f = 2.0\text{ GHz}$ $f = 4.0\text{ GHz}$ $f = 6.0\text{ GHz}$	dB	12.0	16.0 13.0 10.0
P _{1 dB}	Output Power @ 1 dB Gain Compression: $V_{DS} = 5\text{ V}, I_{DS} = 80\text{ mA}$	$f = 4.0\text{ GHz}$	dBm		23.0
G _{1 dB}	1dB Compressed Gain: $V_{DS} = 5\text{ V}, I_{DS} = 80\text{ mA}$	$f = 4.0\text{ GHz}$	dB		13.0
g _m	Transconductance: $V_{DS} = 3\text{ V}, V_{GS} = 0\text{ V}$		mmho	70	120
I _{DS}	Saturated Drain Current: $V_{DS} = 3\text{ V}, V_{GS} = 0\text{ V}$		mA	80	120
V _P	Pinchoff Voltage: $V_{DS} = 3\text{ V}, I_{DS} = 1\text{ mA}$		V	-3.0	-1.5

Absolute Maximum Ratings

Parameter	Symbol	Absolute Maximum ¹
Drain-Source Voltage	V _{DS}	+7 V
Gate-Source Voltage	V _{GS}	-4 V
Drain Current	I _{DS}	I _{DSS}
Power Dissipation ^{2,3}	P _T	600 mW
Channel Temperature	T _{CH}	175°C
Storage Temperature	T _{STG}	-65°C to +175°C

Thermal Resistance: $\theta_{jc} = 250^\circ\text{C/W}$; T_{CH} = 150°C
Liquid Crystal Measurement; 1 μm Spot Size⁴

Notes:

- Operation of this device above any one of these parameters may cause permanent damage.
- Case Temperature = 25°C.
- Derate at 4 mW/°C for T_{CASE} > 25°C.
- The small spot size of this technique results in a higher, though more accurate determination of θ_{jc} than do alternate methods. See MEASUREMENTS section for more information.

Typical Performance, T_A = 25°C

(unless otherwise noted)

OPTIMUM NOISE FIGURE AND ASSOCIATED GAIN vs. I_{DS}
V_{DS} = 3 V, f = 4.0 GHz

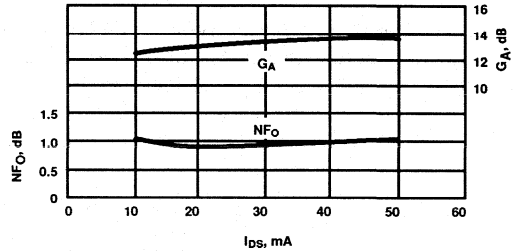

INSERTION POWER GAIN, MAXIMUM AVAILABLE GAIN AND MAXIMUM STABLE GAIN vs. FREQUENCY
V_{DS} = 3 V, I_{DS} = 20 mA

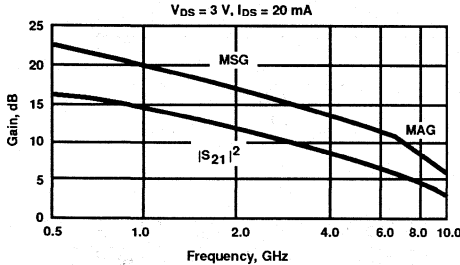

INSERTION POWER GAIN, MAXIMUM AVAILABLE GAIN AND MAXIMUM STABLE GAIN vs. FREQUENCY
V_{DS} = 5 V, I_{DS} = 80 mA

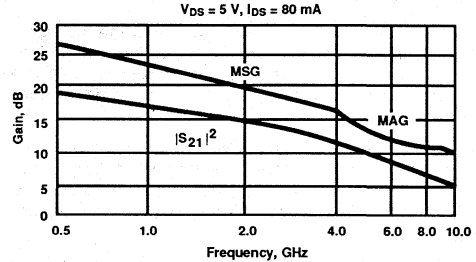

Typical Scattering Parameters: Common Source, Z₀ = 50 Ω

T_A = 25°C, V_{DS} = 3 V, I_{DS} = 20 mA

Freq. GHz	S ₁₁		dB	S ₂₁		dB	S ₁₂		S ₂₂	
	Mag	Ang		Mag	Ang		Mag	Ang	Mag	Ang
0.5	.96	-31	15.5	5.93	157	-29.4	.034	72	.46	-23
1.0	.91	-55	14.2	5.14	137	-24.3	.061	56	.42	-42
2.0	.82	-95	12.1	4.05	106	-20.4	.096	36	.39	-70
3.0	.74	-123	10.2	3.23	82	-19.5	.106	21	.35	-91
4.0	.70	-147	8.8	2.74	61	-18.7	.116	9	.33	-109
5.0	.65	-170	7.3	2.33	41	-18.2	.123	-1	.30	-127
6.0	.64	167	6.3	2.07	22	-17.7	.131	-10	.29	-145
7.0	.65	146	5.4	1.86	4	-17.5	.134	-17	.26	-167
8.0	.66	126	4.5	1.67	-13	-17.0	.141	-28	.26	164
9.0	.66	107	3.4	1.48	-30	-16.6	.148	-39	.26	140
10.0	.67	87	2.2	1.29	-47	-16.2	.155	-50	.25	114

T_A = 25°C, V_{DS} = 5 V, I_{DS} = 80 mA

0.5	.95	-43	18.3	8.24	149	-32.4	.024	67	.49	-17
1.0	.89	-64	17.4	7.28	133	-29.9	.032	59	.46	-26
2.0	.78	-106	14.6	5.36	101	-25.2	.055	44	.40	-45
3.0	.69	-133	12.4	4.18	79	-23.4	.068	34	.38	-60
4.0	.64	-160	10.7	3.42	56	-22.7	.073	31	.36	-81
5.0	.60	175	9.1	2.85	37	-21.7	.082	24	.35	-100
6.0	.61	154	7.9	2.47	18	-20.4	.095	19	.33	-115
7.0	.61	136	6.9	2.22	2	-19.3	.108	12	.31	-132
8.0	.63	120	6.2	2.05	-14	-17.9	.127	7	.27	-152
9.0	.64	102	5.3	1.85	-32	-16.6	.148	0	.27	-179
10.0	.64	86	4.5	1.68	-48	-15.3	.172	-13	.29	165

A model for this device is available in the DEVICE MODELS section.

Features

- **Low Noise Figure: 0.8 dB typical at 4 GHz**
- **High Associated Gain: 14.0 dB typical at 4 GHz**
- **High Output Power: 21.0 dBm typical P_{1 dB} at 4 GHz**

Description

Avantek's ATF-25100 is a high performance gallium arsenide Schottky-barrier-gate field effect transistor chip. Its noise figure makes this device appropriate for use in low noise amplifiers operating in the 0.5-10 GHz frequency range.

This GaAs FET device has a nominal 0.3 micron gate length using airbridge interconnects between drain fingers. Total gate periphery is 500 microns. Proven gold based metallization systems and nitride passivation assure a rugged, reliable device.

The recommended mounting procedure is to die attach at a stage temperature of 300°C using a gold-tin preform under forming gas. Assembly can be performed with either wedge or ball bonding using 0.7 mil gold wire. See also "Chip Use" in the APPLICATIONS section.

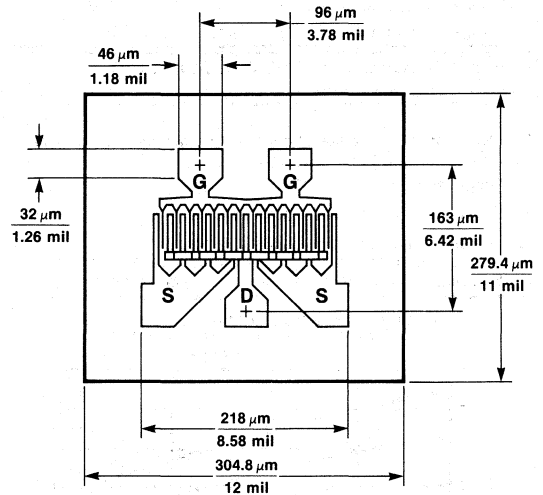
Avantek Chip Outline

Noise Parameters: V_{DS} = 3 V, I_{DS} = 20 mA

Freq. GHz	NF ₀ dB	Gamma Mag	Opt Ang	R _{N/50}
1.0	0.5	.91	11	1.03
2.0	0.6	.83	22	.79
4.0	0.8	.57	63	.67
6.0	1.0	.50	101	.23
8.0	1.2	.47	135	.34

Electrical Specifications, T_A = 25°C

Symbol	Parameters and Test Conditions ¹	Units	Min.	Typ.	Max.
NF ₀	Optimum Noise Figure: V _{DS} = 3 V, I _{DS} = 20 mA f = 4.0 GHz	dB		0.8	1.0
G _A	Gain @ NF ₀ : V _{DS} = 3 V, I _{DS} = 20 mA f = 4.0 GHz	dB	13.0	1.0	
		dB		1.2	
		dB		9.0	
P _{1 dB}	Output Power @ 1 dB Gain Compression: V _{DS} = 5 V, I _{DS} = 50 mA f = 4.0 GHz	dBm		21.0	
G _{1 dB}	1dB Compressed Gain: V _{DS} = 5 V, I _{DS} = 50 mA f = 4.0 GHz	dB		15.0	
g _m	Transconductance: V _{DS} = 3 V, V _{GS} = 0 V	mmho	50	80	
I _{DSS}	Saturated Drain Current: V _{DS} = 3 V, V _{GS} = 0 V	mA	50	100	150
V _p	Pinchoff Voltage: V _{DS} = 3 V, I _{DS} = 1 mA	V	-3.0	-2.0	-0.8

Note: 1. RF Performance is determined by assembling and testing 10 samples per wafer.

Absolute Maximum Ratings

Parameter	Symbol	Absolute Maximum ¹
Drain-Source Voltage	V _{DS}	+7 V
Gate-Source Voltage	V _{GS}	-4 V
Drain Current	I _{DS}	I _{DSS}
Power Dissipation ^{2,3}	P _T	450 mW
Channel Temperature	T _{CH}	175°C
Storage Temperature	T _{STG}	-65°C to +175°C

Thermal Resistance: $\theta_{JC} = 200^\circ\text{C/W}$; T_{CH} = 150°C
Liquid Crystal Measurement; 1 μm Spot Size⁴

Notes:

1. Operation of this device above any one of these parameters may cause permanent damage.
2. Mounting Surface Temperature = 25°C.
3. Derate at 5 mW/°C for T_{MOUNTING SURFACE} > 85°C.
4. The small spot size of this technique results in a higher, though more accurate determination of θ_{JC} than do alternate methods. See MEASUREMENTS section for more information.

Part Number Ordering Information

Part Number	Devices Per Tray
ATF-25100-GP1	5
ATF-25100-GP3	50
ATF-25100-GP6	up to 300

Typical Performance, T_A = 25°C
(unless otherwise noted)

OPTIMUM NOISE FIGURE AND ASSOCIATED GAIN vs. FREQUENCY
V_{DS} = 3 V, I_{DS} = 20 mA

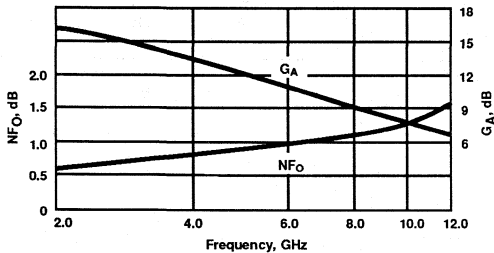

OPTIMUM NOISE FIGURE AND ASSOCIATED GAIN vs. I_{DS}
V_{DS} = 3 V, f = 4.0 GHz

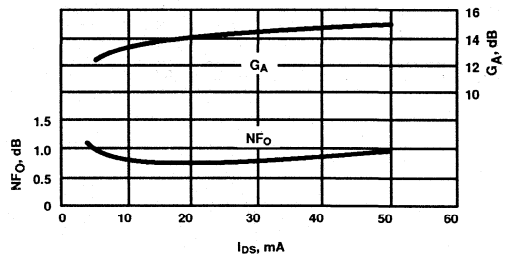

INSERTION POWER GAIN, MAXIMUM AVAILABLE GAIN AND MAXIMUM STABLE GAIN vs. FREQUENCY
V_{DS} = 3 V, I_{DS} = 20 mA

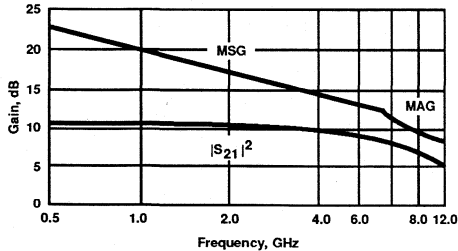

INSERTION POWER GAIN, MAXIMUM AVAILABLE GAIN AND MAXIMUM STABLE GAIN vs. FREQUENCY
V_{DS} = 5 V, I_{DS} = 50 mA

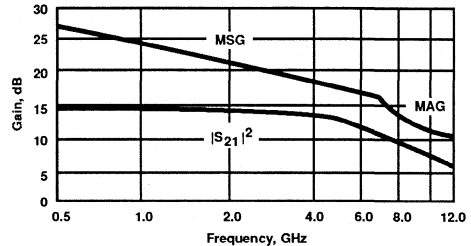

ATF-25100, 0.5-10 GHz
Low Noise Gallium Arsenide FET

Typical Scattering Parameters: Common Source, $Z_0 = 50 \Omega$

$T_A = 25^\circ\text{C}$, $V_{DS} = 3 \text{ V}$, $I_{DS} = 20 \text{ mA}$

Freq. GHz	S_{11}		S_{21}			S_{12}			S_{22}	
	Mag	Ang	dB	Mag	Ang	dB	Mag	Ang	Mag	Ang
0.5	.98	-11	10.4	3.30	173	-34.9	.018	89	.53	-3
1.0	.98	-19	10.4	3.30	165	-29.9	.032	84	.52	-6
2.0	.96	-35	10.3	3.29	150	-24.3	.061	74	.47	-12
3.0	.94	-53	10.1	3.22	134	-21.0	.089	64	.41	-23
4.0	.87	-74	9.9	3.13	117	-19.0	.112	55	.32	-33
5.0	.79	-94	9.2	2.88	103	-18.1	.125	49	.24	-43
6.0	.74	-115	8.6	2.68	89	-17.0	.141	39	.13	-60
7.0	.70	-134	7.7	2.43	77	-16.7	.146	35	.03	-167
8.0	.66	-151	6.8	2.20	67	-16.3	.153	32	.07	155
9.0	.66	-163	6.4	2.09	57	-15.9	.160	25	.13	138
10.0	.67	-176	5.7	1.93	46	-15.8	.163	23	.17	135
11.0	.68	171	5.2	1.81	37	-15.5	.167	18	.23	132
12.0	.68	162	4.5	1.68	24	-15.4	.170	9	.24	130

$T_A = 25^\circ\text{C}$, $V_{DS} = 5 \text{ V}$, $I_{DS} = 50 \text{ mA}$

0.5	.98	-14	14.6	5.40	173	-39.2	.011	88	.69	-1
1.0	.98	-25	14.5	5.32	163	-34.0	.020	82	.67	-5
2.0	.93	-47	14.3	5.16	144	-28.4	.038	71	.60	-12
3.0	.89	-70	13.7	4.82	127	-25.0	.056	65	.53	-17
4.0	.82	-94	13.0	4.48	110	-23.4	.068	52	.46	-20
5.0	.75	-117	11.8	3.88	97	-22.5	.075	50	.40	-24
6.0	.71	-137	10.9	3.51	83	-21.9	.080	46	.31	-29
7.0	.70	-159	9.7	3.07	71	-21.6	.083	42	.22	-35
8.0	.71	-169	8.7	2.73	63	-21.3	.086	41	.16	-42
9.0	.72	180	8.1	2.53	54	-20.9	.090	40	.12	-46
10.0	.73	172	7.3	2.31	44	-20.6	.093	39	.09	-55
11.0	.74	162	6.6	2.13	35	-20.2	.098	36	.05	-131
12.0	.73	150	6.4	2.08	21	-19.7	.104	34	.08	-170

A model for this device is available in the DEVICE MODELS section.

Features

- Low Noise Figure: 0.8 dB typical at 4 GHz
- High Associated Gain: 14.0 dB typical at 4 GHz
- High Output Power: 21.0 dBm typical $P_{1\text{ dB}}$ at 4 GHz
- Hermetic Gold-Ceramic Microstrip Package

Description

Avantek's ATF-25170 is a high performance gallium arsenide Schottky-barrier-gate field effect transistor housed in a hermetic, high reliability package. Its noise figure makes this device appropriate for use in low noise amplifiers operating in the 0.5-10 GHz frequency range.

This GaAs FET device has a nominal 0.3 micron gate length using airbridge interconnects between drain fingers. Total gate periphery is 500 microns. Proven gold based metallization systems and nitride passivation assure a rugged, reliable device.

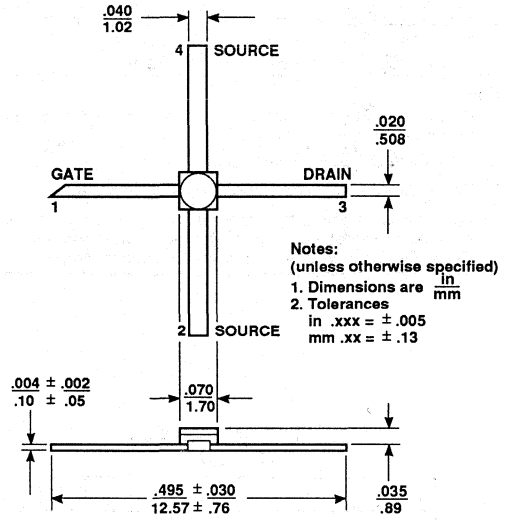
Avantek 70 mil Package

Noise Parameters: $V_{DS} = 3\text{ V}$, $I_{DS} = 20\text{ mA}$

Freq. GHz	NF ₀ dB	Gamma Opt Mag	Ang	R _N /50
1.0	0.6	.89	24	.78
2.0	0.7	.77	50	.53
4.0	0.8	.63	105	.33
6.0	1.0	.66	147	.06
8.0	1.2	.62	-159	.11

Electrical Specifications, $T_A = 25^\circ\text{C}$

Symbol	Parameters and Test Conditions	Units	Min.	Typ.	Max.
NF ₀	Optimum Noise Figure: $V_{DS} = 3\text{ V}$, $I_{DS} = 20\text{ mA}$	f = 4.0 GHz f = 6.0 GHz f = 8.0 GHz	dB dB dB	0.8 1.0 1.2	1.0
G _A	Gain @ NF ₀ : $V_{DS} = 3\text{ V}$, $I_{DS} = 20\text{ mA}$	f = 4.0 GHz f = 6.0 GHz f = 8.0 GHz	dB dB dB	13.0 14.0 11.5 9.0	
P ₁ dB	Output Power @ 1 dB Gain Compression: $V_{DS} = 5\text{ V}$, $I_{DS} = 50\text{ mA}$	f = 4.0 GHz	dBm	21.0	
G ₁ dB	1dB Compressed Gain: $V_{DS} = 5\text{ V}$, $I_{DS} = 50\text{ mA}$	f = 4.0 GHz	dB	15.0	
g _m	Transconductance: $V_{DS} = 3\text{ V}$, $V_{GS} = 0\text{ V}$		mmho	50	80
I _{DSS}	Saturated Drain Current: $V_{DS} = 3\text{ V}$, $V_{GS} = 0\text{ V}$		mA	50	100
V _P	Pinchoff Voltage: $V_{DS} = 3\text{ V}$, $I_{DS} = 1\text{ mA}$		V	-3.0	-2.0

ATF-25170, 0.5-10 GHz Low Noise Gallium Arsenide FET

Absolute Maximum Ratings

Parameter	Symbol	Absolute Maximum ¹
Drain-Source Voltage	V _{DS}	+7 V
Gate-Source Voltage	V _{GS}	-4 V
Drain Current	I _{DS}	I _{DSS}
Power Dissipation ^{2,3}	P _T	450 mW
Channel Temperature	T _{CH}	175°C
Storage Temperature	T _{STG}	-65°C to +175°C

Thermal Resistance: $\theta_{jc} = 300^\circ\text{C/W}$; T_{CH} = 150°C
Liquid Crystal Measurement; 1 μm Spot Size⁴

Notes:

- Operation of this device above any one of these parameters may cause permanent damage.
- Mounting Surface Temperature = 25°C.
- Derate at 3.3 mW/°C for T_{MOUNTING SURFACE} > 40°C.
- The small spot size of this technique results in a higher, though more accurate determination of θ_{jc} than do alternate methods. See MEASUREMENTS section for more information.

Typical Performance, T_A = 25°C

(unless otherwise noted)

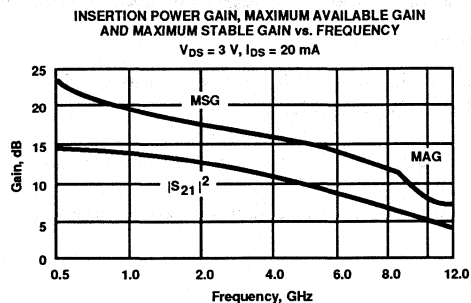

OPTIMUM NOISE FIGURE AND ASSOCIATED GAIN vs. FREQUENCY
V_{DS} = 3 V, I_{DS} = 20 mA

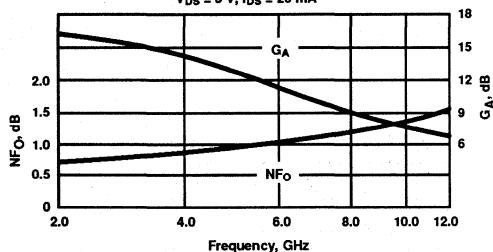

OPTIMUM NOISE FIGURE AND ASSOCIATED GAIN vs. I_{DS}
V_{DS} = 3 V, f = 4.0 GHz

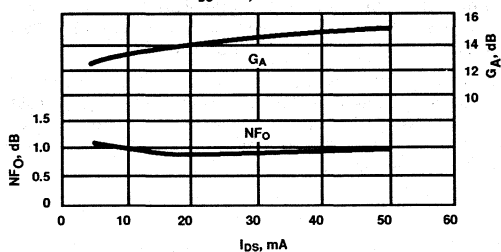

Typical Scattering Parameters: Common Source, Z₀ = 50 Ω

T_A = 25°C, V_{DS} = 3 V, I_{DS} = 20 mA

Freq. GHz	S ₁₁		S ₂₁			S ₁₂			S ₂₂	
	Mag	Ang	dB	Mag	Ang	dB	Mag	Ang	Mag	Ang
0.5	.98	-23	13.6	4.80	160	-32.8	.023	76	.50	-23
1.0	.96	-38	13.0	4.46	147	-23.6	.037	67	.48	-30
2.0	.88	-66	11.5	3.75	121	-23.6	.066	50	.44	-45
3.0	.80	-86	10.2	3.23	102	-21.8	.081	41	.41	-55
4.0	.77	-106	9.3	2.93	82	-19.7	.103	28	.38	-65
5.0	.71	-127	8.5	2.66	62	-18.6	.118	17	.35	-78
6.0	.65	-149	7.9	2.47	42	-17.7	.130	6	.30	-93
7.0	.60	-173	7.3	2.33	24	-16.5	.149	-4	.26	-111
8.0	.56	161	6.8	2.20	5	-15.8	.162	-16	.22	-134
9.0	.56	136	6.2	2.05	-14	-15.1	.175	-26	.21	-166
10.0	.55	118	5.4	1.87	-31	-15.0	.178	-35	.21	173
11.0	.53	108	4.9	1.76	-46	-14.9	.180	-42	.22	164
12.0	.53	95	4.7	1.71	-62	-14.8	.183	-52	.23	159

A model for this device is available in the DEVICE MODELS section.

Features

- High Output Power: 20.5 dBm typical $P_{1\text{ dB}}$ at 4 GHz
- High Associated Gain: 14.0 dB typical at 4 GHz
- Low Noise Figure: 1.0 dB typical at 4 GHz
- Hermetic Gold-Ceramic Microstrip Package

Description

Avantek's ATF-25570 is a high performance gallium arsenide Schottky-barrier-gate field effect transistor housed in a hermetic, high reliability package. This device is designed for use in general purpose amplifier and oscillator applications in the 0.5-10 GHz frequency range.

This GaAs FET device has a nominal 0.3 micron gate length using airbridge interconnects between drain fingers. Total gate periphery is 500 microns. Proven gold based metallization systems and nitride passivation assure a rugged, reliable device.

Avantek 70 mil Package

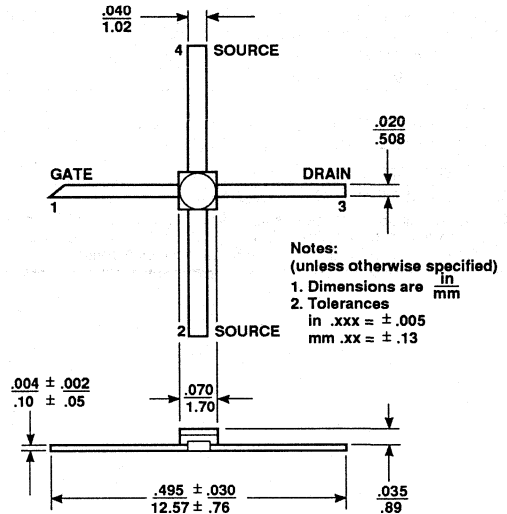

INSERTION POWER GAIN, MAXIMUM AVAILABLE GAIN AND MAXIMUM STABLE GAIN vs. FREQUENCY
 $V_{DS} = 3\text{ V}, I_{DS} = 20\text{ mA}, T_A = 25^\circ\text{C}$

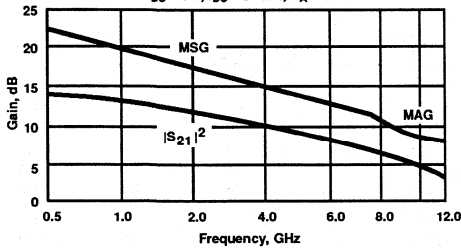

Electrical Specifications, $T_A = 25^\circ\text{C}$

Symbol	Parameters and Test Conditions	Units	Min.	Typ.	Max.
NFO	Optimum Noise Figure: $V_{DS} = 3\text{ V}, I_{DS} = 20\text{ mA}$	$f = 4.0\text{ GHz}$ $f = 6.0\text{ GHz}$ $f = 8.0\text{ GHz}$		1.0 1.2 1.4	1.3
GA	Gain @ NFO: $V_{DS} = 3\text{ V}, I_{DS} = 20\text{ mA}$	$f = 4.0\text{ GHz}$ $f = 6.0\text{ GHz}$ $f = 8.0\text{ GHz}$	13.0	14.0 11.0 8.5	
$P_{1\text{ dB}}$	Output Power @ 1 dB Gain Compression: $V_{DS} = 5\text{ V}, I_{DS} = 50\text{ mA}$	$f = 4.0\text{ GHz}$		20.5	
G_1 dB	1dB Compressed Gain: $V_{DS} = 5\text{ V}, I_{DS} = 50\text{ mA}$	$f = 4.0\text{ GHz}$		13.0	
g_m	Transconductance: $V_{DS} = 3\text{ V}, V_{GS} = 0\text{ V}$	mmho	50	80	
I_{DSS}	Saturated Drain Current: $V_{DS} = 3\text{ V}, V_{GS} = 0\text{ V}$	mA	50	100	150
V_p	Pinchoff Voltage: $V_{DS} = 3\text{ V}, I_{DS} = 1\text{ mA}$	V	-3.0	-2.0	-0.8

ATF-25570, 0.5-10 GHz General Purpose Gallium Arsenide FET

Absolute Maximum Ratings

Parameter	Symbol	Absolute Maximum ¹
Drain-Source Voltage	V _{DS}	+7 V
Gate-Source Voltage	V _{GS}	-4 V
Drain Current	I _{DS}	I _{DSS}
Power Dissipation ^{2,3}	P _T	450 mW
Channel Temperature	T _{CH}	175°C
Storage Temperature	T _{STG}	-65°C to +175°C

Thermal Resistance: $\theta_{jc} = 300^\circ\text{C/W}$; T_{CH} = 150°C
Liquid Crystal Measurement; 1 μm Spot Size⁴

Notes:

1. Operation of this device above any one of these parameters may cause permanent damage.
2. Case Temperature = 25°C.
3. Derate at 3.3 mW/°C for T_{CASE} > 40°C.
4. The small spot size of this technique results in a higher, though more accurate determination of θ_{jc} than do alternate methods. See MEASUREMENTS section for more information.

Typical Performance, T_A = 25°C

(unless otherwise noted)

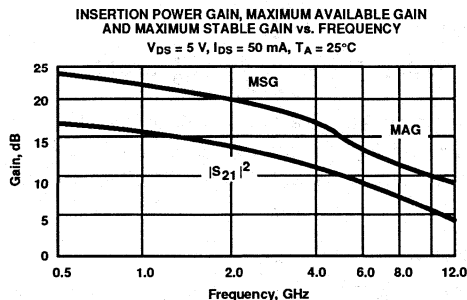

Typical Scattering Parameters: Common Source, Z₀ = 50 Ω

T_A = 25°C, V_{DS} = 3 V, I_{DS} = 20 mA

Freq. GHz	S ₁₁		S ₂₁			S ₁₂			S ₂₂	
	Mag	Ang	dB	Mag	Ang	dB	Mag	Ang	Mag	Ang
0.5	.98	-24	14.0	5.02	160	-28.9	.036	71	.56	-24
1.0	.96	-41	13.4	4.70	145	-26.2	.049	62	.55	-33
2.0	.84	-76	12.3	4.14	115	-22.5	.075	44	.49	-51
3.0	.78	-100	10.8	3.48	94	-20.9	.090	33	.46	-60
4.0	.72	-123	9.6	3.01	73	-19.8	.102	20	.42	-76
5.0	.68	-142	8.5	2.67	54	-18.8	.114	9	.38	-88
6.0	.63	-162	7.8	2.45	36	-18.3	.121	0	.35	-101
7.0	.60	175	7.2	2.30	18	-17.5	.133	-7	.30	-118
8.0	.58	150	6.3	2.06	-1	-17.0	.141	-16	.26	-138
9.0	.59	128	5.6	1.90	-19	-16.7	.146	-28	.25	-167
10.0	.60	113	4.7	1.72	-36	-16.4	.151	-35	.26	172
11.0	.60	104	4.1	1.61	-48	-16.1	.157	-40	.28	155
12.0	.59	91	3.9	1.56	-68	-15.9	.160	-44	.30	146

T_A = 25°C, V_{DS} = 5 V, I_{DS} = 50 mA

0.5	.97	-27	16.2	6.49	156	-32.0	.025	63	.59	-21
1.0	.94	-45	15.5	5.95	141	-29.9	.032	57	.60	-28
2.0	.81	-82	13.5	4.72	111	-26.2	.049	45	.58	-39
3.0	.73	-105	11.7	3.86	91	-24.9	.057	41	.55	-50
4.0	.66	-128	10.3	3.29	70	-23.4	.068	37	.52	-62
5.0	.61	-148	9.2	2.88	52	-22.5	.075	32	.49	-72
6.0	.57	-170	8.5	2.65	34	-21.6	.083	30	.48	-84
7.0	.56	167	7.6	2.41	16	-20.2	.097	28	.45	-98
8.0	.57	145	6.8	2.19	-1	-19.2	.110	18	.42	-115
9.0	.59	127	6.0	2.00	-18	-18.5	.119	12	.40	-136
10.0	.60	115	5.2	1.82	-35	-17.8	.129	4	.40	-159
11.0	.60	108	4.7	1.72	-47	-17.5	.134	1	.42	-176
12.0	.57	93	4.5	1.67	-64	-16.9	.143	-10	.44	173

A model for this device is available in the DEVICE MODELS section.

Features

- High Output Power: 19.0 dBm typical $P_{1\text{ dB}}$ at 4 GHz
- High Gain: 12.5 dB typical $G_{1\text{ dB}}$ at 4 GHz
- Low Noise Figure: 1.2 dB typical at 4 GHz
- Cost Effective Ceramic Microstrip Package

Description

Avantek's ATF-25735 is a high performance gallium arsenide Schottky-barrier-gate field effect transistor housed in a cost effective microstrip package. This device is designed for use in general purpose amplifier and oscillator applications in the 0.5-10 GHz frequency range.

This GaAs FET device has a nominal 0.3 micron gate length using airbridge interconnects between drain fingers. Total gate periphery is 500 microns. Proven gold based metallization systems and nitride passivation assure a rugged, reliable device.

Avantek 35 micro-X Package

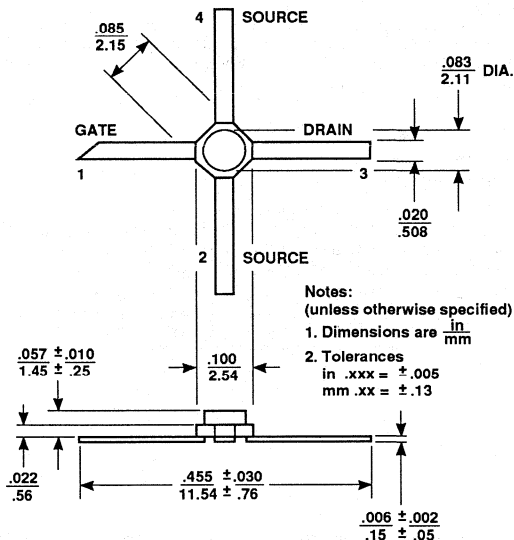

INSERTION POWER GAIN, MAXIMUM AVAILABLE GAIN
AND MAXIMUM STABLE GAIN vs. FREQUENCY
 $V_{DS} = 3\text{ V}$, $I_{DS} = 20\text{ mA}$, $T_A = 25^\circ\text{C}$

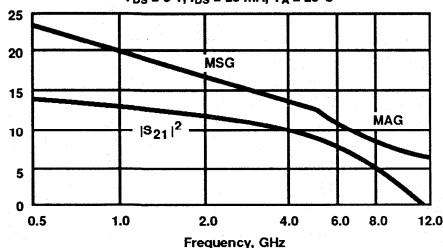

Electrical Specifications, $T_A = 25^\circ\text{C}$

Symbol	Parameters and Test Conditions	Units	Min.	Typ.	Max.
NFO	Optimum Noise Figure: $V_{DS} = 3\text{ V}$, $I_{DS} = 20\text{ mA}$				
	$f = 2.0\text{ GHz}$	dB		1.0	
	$f = 4.0\text{ GHz}$			1.2	1.5
	$f = 6.0\text{ GHz}$			1.4	
G_A	Gain @ NFO: $V_{DS} = 3\text{ V}$, $I_{DS} = 20\text{ mA}$				
	$f = 2.0\text{ GHz}$	dB		15.0	
	$f = 4.0\text{ GHz}$		11.5	13.0	
	$f = 6.0\text{ GHz}$			10.5	
$P_{1\text{ dB}}$	Output Power @ 1 dB Gain Compression: $V_{DS} = 5\text{ V}$, $I_{DS} = 50\text{ mA}$	dBm		19.0	
$G_{1\text{ dB}}$	1dB Compressed Gain: $V_{DS} = 5\text{ V}$, $I_{DS} = 50\text{ mA}$	dB		12.5	
g_m	Transconductance: $V_{DS} = 3\text{ V}$, $V_{GS} = 0\text{ V}$	mmho	50	80	
I_{DSS}	Saturated Drain Current: $V_{DS} = 3\text{ V}$, $V_{GS} = 0\text{ V}$	mA	50	100	150
V_P	Pinchoff Voltage: $V_{DS} = 3\text{ V}$, $I_{DS} = 1\text{ mA}$	V	-3.0	-2.0	-0.8

ATF-25735, 0.5-10 GHz
General Purpose Gallium Arsenide FET

Absolute Maximum Ratings

Parameter	Symbol	Absolute Maximum ¹
Drain-Source Voltage	V _{DS}	+7 V
Gate-Source Voltage	V _{GS}	-4 V
Drain Current	I _{DS}	I _{DSS}
Power Dissipation ^{2,3}	P _T	450 mW
Channel Temperature	T _{CH}	175°C
Storage Temperature ⁴	T _{STG}	-65°C to +175°C

Thermal Resistance: $\theta_{jc} = 325^\circ\text{C/W}$; T_{CH} = 150°C
 Liquid Crystal Measurement; 1 μm Spot Size⁵

Notes:

1. Operation of this device above any one of these parameters may cause permanent damage.
2. Case Temperature = 25°C.
3. Derate at 3 mW/°C for T_{CASE} > 29°C.
4. Storage above +150°C may tarnish the leads of this package difficult to solder into a circuit. After a device has been soldered into a circuit, it may be safely stored up to 175°C.
5. The small spot size of this technique results in a higher, though more accurate determination of θ_{jc} than do alternate methods. See MEASUREMENTS section for more information.

Typical Performance, T_A = 25°C

(unless otherwise noted)

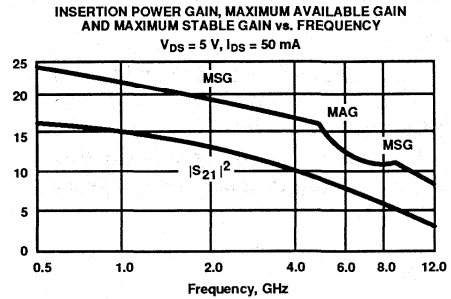

Typical Scattering Parameters: Common Source, Z₀ = 50 Ω

T_A = 25°C, V_{DS} = 3 V, I_{DS} = 20 mA

Freq. GHz	S ₁₁			S ₂₁			S ₁₂			S ₂₂		
	Mag	Ang	dB	Mag	Ang	dB	Mag	Ang	dB	Mag	Ang	
0.5	.98	-22	13.9	4.95	159	-32.0	.025	77	.52	-12		
1.0	.94	-45	13.3	4.61	142	-27.1	.044	64	.52	-20		
2.0	.85	-82	12.2	4.06	110	-21.6	.083	45	.46	-41		
3.0	.70	-116	11.0	3.54	81	-19.3	.109	24	.38	-61		
4.0	.58	-152	10.0	3.17	54	-17.7	.131	12	.35	-81		
5.0	.50	165	8.9	2.78	27	-16.7	.146	-7	.29	-97		
6.0	.52	122	7.7	2.43	1	-16.1	.156	-20	.18	-112		
7.0	.59	90	6.3	2.06	-23	-15.8	.162	-34	.07	-161		
8.0	.65	66	5.1	1.79	-43	-15.5	.167	-46	.09	107		
9.0	.69	44	3.8	1.55	-63	-15.3	.172	-53	.15	76		
10.0	.73	32	2.7	1.36	-82	-15.4	.170	-65	.18	53		
11.0	.79	20	1.1	1.14	-100	-15.5	.168	-78	.21	24		
12.0	.84	7	-0.2	.98	-119	-15.7	.161	-93	.26	-5		

T_A = 25°C, V_{DS} = 5 V, I_{DS} = 50 mA

0.5	.93	-21	16.0	6.29	156	-34.0	.020	69	.56	-10
1.0	.88	-42	15.4	5.89	140	-29.6	.033	62	.53	-21
2.0	.78	-81	14.1	5.08	108	-24.4	.060	49	.47	-43
3.0	.65	-112	12.6	4.27	83	-22.6	.074	39	.44	-55
4.0	.55	-142	11.4	3.73	58	-21.0	.089	28	.41	-64
5.0	.48	-176	10.6	3.37	36	-19.7	.104	20	.37	-69
6.0	.47	142	9.7	3.04	10	-18.3	.122	6	.28	-83
7.0	.56	104	8.4	2.64	-14	-17.5	.134	-6	.14	-105
8.0	.65	80	7.0	2.25	-35	-16.7	.146	-17	.07	172
9.0	.73	61	5.8	1.94	-53	-16.1	.157	-26	.14	113
10.0	.78	47	4.7	1.71	-72	-15.4	.169	-40	.20	94
11.0	.80	34	3.6	1.51	-90	-15.1	.176	-53	.27	68
12.0	.85	18	2.7	1.36	-109	-14.8	.181	-64	.36	45

A model for this device is available in the DEVICE MODELS section.

Features

- **Low Noise Figure: 1.8 dB typical at 12 GHz**
- **High Associated Gain: 9.0 dB typical at 12 GHz**
- **High Output Power: 18.0 dBm typical $P_{1\text{ dB}}$ at 12 GHz**

Description

Avantek's ATF-26100 is a high performance gallium arsenide Schottky-barrier-gate field effect transistor chip. This device is designed for use in low noise, wideband amplifier and oscillator applications in the 2-18 GHz frequency range.

This GaAs FET chip has a nominal 0.3 micron gate length with a total gate periphery of 250 microns. Proven gold based metallization systems and nitride passivation assure a rugged, reliable device.

The recommended mounting procedure is to die attach at a stage temperature of 300°C using a gold-tin preform under forming gas. Assembly can be performed with either wedge or ball bonding using 0.7 mil gold wire. See also "Chip Use" in the APPLICATIONS section.

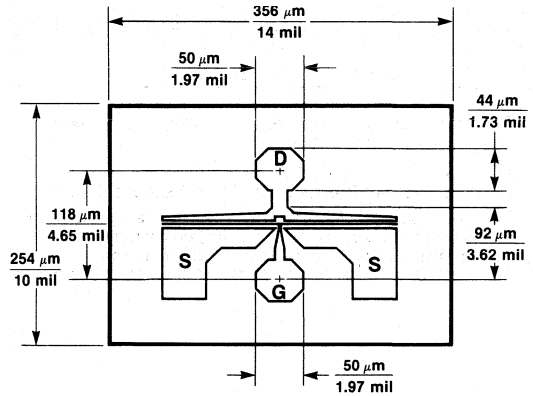
Avantek Chip Outline

Noise Parameters: $V_{DS} = 3\text{ V}$, $I_{DS} = 10\text{ mA}$

Freq. GHz	NF ₀ dB	Gamma Opt Mag	Ang	R _N /50
6.0	1.3	.67	52	1.08
8.0	1.5	.45	84	1.03
12.0	1.8	.22	-158	.84
14.0	2.0	.33	-136	.91

Electrical Specifications, $T_A = 25^\circ\text{C}$

Symbol	Parameters and Test Conditions ¹	Units	Min.	Typ.	Max.	
NF ₀	Optimum Noise Figure: $V_{DS} = 3\text{ V}$, $I_{DS} = 10\text{ mA}$	$f = 8.0\text{ GHz}$ $f = 12.0\text{ GHz}$ $f = 14.0\text{ GHz}$	dB		1.5 1.8 2.0	2.2
G _A	Gain @ NF ₀ : $V_{DS} = 3\text{ V}$, $I_{DS} = 10\text{ mA}$	$f = 8.0\text{ GHz}$ $f = 12.0\text{ GHz}$ $f = 14.0\text{ GHz}$	dB	8.0	12.0 9.0 8.0	
$P_{1\text{ dB}}$	Output Power @ 1 dB Gain Compression: $V_{DS} = 5\text{ V}$, $I_{DS} = 30\text{ mA}$	$f = 12.0\text{ GHz}$	dBm		18.0	
G ₁	1dB Compressed Gain: $V_{DS} = 5\text{ V}$, $I_{DS} = 30\text{ mA}$	$f = 12.0\text{ GHz}$	dB		8.0	
g _m	Transconductance: $V_{DS} = 3\text{ V}$, $V_{GS} = 0\text{ V}$		mmho	20	40	
I _{DSS}	Saturated Drain Current: $V_{DS} = 3\text{ V}$, $V_{GS} = 0\text{ V}$		mA	25	50	90
V _P	Pinchoff Voltage: $V_{DS} = 3\text{ V}$, $I_{DS} = 1\text{ mA}$		V	-3.0	-1.7	-0.8

Note: 1. RF performance is determined by assembling and testing 10 samples per wafer.

ATF-26100, 2-18 GHz General Purpose Gallium Arsenide FET

Absolute Maximum Ratings

Parameter	Symbol	Absolute Maximum ¹
Drain-Source Voltage	V _{DS}	+7 V
Gate-Source Voltage	V _{GS}	-4 V
Drain Current	I _{DS}	I _{DSS}
Power Dissipation ^{2,3}	P _T	275 mW
Channel Temperature	T _{CH}	175°C
Storage Temperature	T _{STG}	-65°C to +175°C

Thermal Resistance: $\theta_{jC} = 225^{\circ}\text{C/W}$; T_{CH} = 150°C
Liquid Crystal Measurement; 1 μm Spot Size⁴

Notes:

1. Operation of this device above any one of these parameters may cause permanent damage.
2. Mounting Surface Temperature = 25°C.
3. Derate at 4.4 mW/°C for T_{MOUNTING SURFACE} > 113°C.
4. The small spot size of this technique results in a higher, though more accurate determination of θ_{jC} than do alternate methods. See MEASUREMENTS section for more information.

Part Number Ordering Information

Part Number	Devices Per Tray
ATF-26100-GP1	5
ATF-26100-GP3	50
ATF-26100-GP6	up to 300

Typical Performance, T_A = 25°C

(unless otherwise noted)

OPTIMUM NOISE FIGURE AND ASSOCIATED GAIN vs. FREQUENCY
V_{DS} = 3 V, I_{DS} = 10 mA

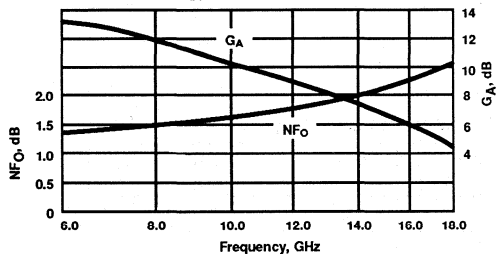

OPTIMUM NOISE FIGURE AND ASSOCIATED GAIN vs. I_{DS}
V_{DS} = 3 V, f = 12 GHz

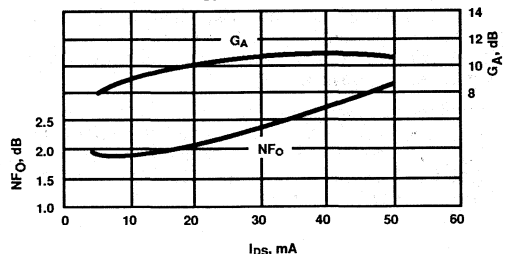

INSERTION POWER GAIN, MAXIMUM AVAILABLE GAIN AND MAXIMUM STABLE GAIN vs. FREQUENCY
V_{DS} = 3 V, I_{DS} = 10 mA

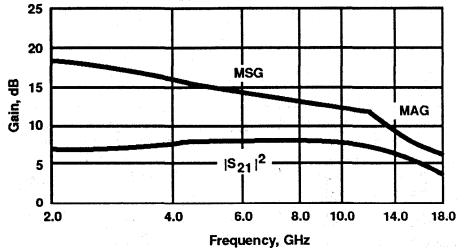

INSERTION POWER GAIN, MAXIMUM AVAILABLE GAIN AND MAXIMUM STABLE GAIN vs. FREQUENCY
V_{DS} = 5 V, I_{DS} = 30 mA

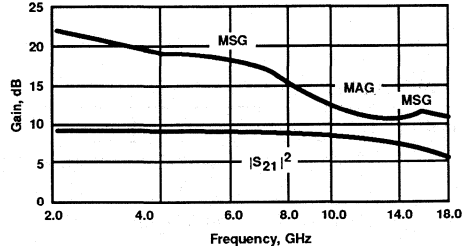

ATF-26100, 2-18 GHz
General Purpose Gallium Arsenide FET

Typical Scattering Parameters: Common Source, $Z_0 = 50 \Omega$

$T_A = 25^\circ\text{C}$, $V_{DS} = 3 \text{ V}$, $I_{DS} = 10 \text{ mA}$

Freq. GHz	S_{11}		S_{21}			S_{12}			S_{22}	
	Mag	Ang	dB	Mag	Ang	dB	Mag	Ang	Mag	Ang
2.0	.98	-19	6.5	2.11	161	-29.4	.034	82	.68	-4
3.0	.96	-28	6.5	2.11	151	-25.8	.051	78	.67	-6
4.0	.93	-37	6.6	2.15	142	-23.5	.067	74	.64	-9
5.0	.90	-47	6.9	2.22	131	-21.5	.084	69	.61	-13
6.0	.86	-59	7.1	2.27	120	-19.9	.101	64	.57	-17
7.0	.80	-72	7.2	2.29	110	-18.6	.117	59	.52	-23
8.0	.74	-83	7.3	2.32	100	-17.7	.130	54	.48	-28
9.0	.68	-97	7.3	2.33	89	-16.9	.143	48	.43	-36
10.0	.61	-114	7.3	2.31	77	-16.1	.156	42	.38	-46
11.0	.55	-133	7.1	2.27	66	-15.6	.166	35	.33	-56
12.0	.52	-153	6.8	2.18	54	-15.2	.174	28	.28	-66
13.0	.49	-174	6.4	2.10	44	-14.9	.180	21	.24	-78
14.0	.49	165	6.0	2.00	33	-14.7	.184	10	.17	-99
15.0	.52	144	5.3	1.84	21	-14.6	.186	6	.15	-109
16.0	.54	131	4.6	1.69	12	-14.6	.187	3	.13	-121
17.0	.57	117	4.0	1.58	3	-14.5	.189	-6	.10	-177
18.0	.58	105	3.2	1.45	-6	-14.4	.190	-12	.13	145

$T_A = 25^\circ\text{C}$, $V_{DS} = 5 \text{ V}$, $I_{DS} = 30 \text{ mA}$

2.0	.98	-22	9.6	3.01	158	-33.2	.022	85	.71	-3
3.0	.93	-34	9.5	2.98	146	-30.8	.029	81	.70	-5
4.0	.87	-45	9.6	3.02	136	-28.2	.039	78	.68	-8
5.0	.81	-59	9.7	3.05	124	-25.8	.051	76	.65	-11
6.0	.74	-72	9.5	2.98	112	-24.7	.058	74	.62	-14
7.0	.68	-86	9.1	2.86	101	-23.4	.068	72	.60	-18
8.0	.63	-100	8.9	2.80	91	-22.5	.075	70	.57	-22
9.0	.56	-113	8.8	2.76	82	-21.7	.082	69	.55	-26
10.0	.51	-130	8.4	2.62	72	-20.6	.096	68	.53	-30
11.0	.46	-143	8.0	2.52	62	-20.0	.100	66	.51	-40
12.0	.42	-156	7.8	2.45	54	-19.6	.105	64	.47	-49
13.0	.41	-168	7.5	2.37	46	-18.9	.114	60	.46	-54
14.0	.40	164	7.2	2.29	38	-17.8	.129	56	.44	-60
15.0	.41	145	6.6	2.15	29	-16.9	.143	52	.42	-65
16.0	.44	132	6.2	2.04	21	-15.5	.167	45	.40	-72
17.0	.47	120	5.9	1.97	11	-14.7	.185	40	.35	-80
18.0	.51	104	5.2	1.83	2	-14.6	.187	34	.30	-93

A model for this device is available in the DEVICE MODELS section.

Features

- **Low Noise Figure: 1.8 dB typical at 12 GHz**
- **High Associated Gain: 9.0 dB typical at 12 GHz**
- **High Output Power: 18.0 dBm typical P_{1 dB} at 12 GHz**
- **Hermetic Gold-Ceramic Microstrip Package**

Description

Avantek's ATF-26150 is a high performance gallium arsenide Schottky-barrier-gate field effect transistor housed in a hermetic, high reliability package. Its noise figure makes this device appropriate for use in low noise amplifiers operating in the 2-16 GHz frequency range.

This GaAs FET device has a nominal 0.3 micron gate length with a total gate periphery of 250 microns. Proven gold based metallization systems and nitride passivation assure a rugged, reliable device.

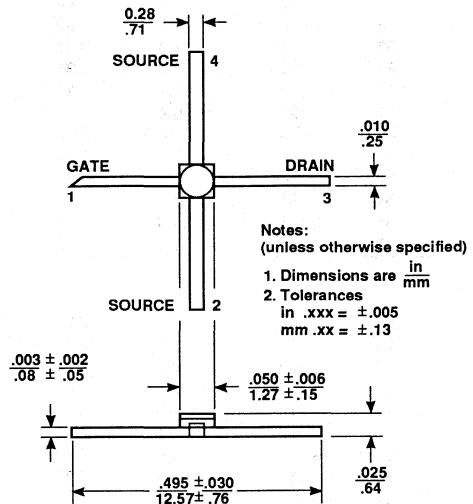
Avantek 50 mil Package

Noise Parameters: V_{DS} = 3 V, I_{DS} = 10 mA

Freq. GHz	NF ₀ dB	Gamma Mag	Opt Ang	R _N /50
6.0	1.3	.59	74	.77
8.0	1.5	.57	110	.56
12.0	1.8	.63	178	.06
14.0	2.0	.70	-134	.73

Electrical Specifications, T_A = 25°C

Symbol	Parameters and Test Conditions	Units	Min.	Typ.	Max.
NF ₀	Optimum Noise Figure: V _{DS} = 3 V, I _{DS} = 10 mA	f = 8.0 GHz dB f = 12.0 GHz dB f = 14.0 GHz dB		1.5 1.8 2.0	2.2
G _A	Gain @ NF ₀ : V _{DS} = 3 V, I _{DS} = 10 mA	f = 8.0 GHz dB f = 12.0 GHz dB f = 14.0 GHz dB	8.0	11.5 9.0 8.0	
P _{1 dB}	Output Power @ 1 dB Gain Compression: V _{DS} = 5 V, I _{DS} = 30 mA	f = 12.0 GHz		18.0	
G _{1 dB}	1 dB Compressed Gain: V _{DS} = 5 V, I _{DS} = 30 mA	f = 12.0 GHz		8.0	
g _m	Transconductance: V _{DS} = 3 V, V _{GS} = 0 V	mmho	20	40	
I _{DSS}	Saturated Drain Current: V _{DS} = 3 V, V _{GS} = 0 V	mA	25	50	90
V _p	Pinchoff Voltage: V _{DS} = 3 V, I _{DS} = 1 mA	V	-3.0	-1.7	-0.8

Absolute Maximum Ratings

Parameter	Symbol	Absolute Maximum ¹
Drain-Source Voltage	V _{DS}	+7 V
Gate-Source Voltage	V _{GS}	-4 V
Drain Current	I _{DS}	I _{DSS}
Power Dissipation ^{2,3}	P _T	275 mW
Channel Temperature	T _{CH}	175°C
Storage Temperature	T _{STG}	-65°C to +175°C

Thermal Resistance: $\theta_{jc} = 325^\circ\text{C/W}$; T_{CH} = 150°C
 Liquid Crystal Measurement; 1 μm Spot Size⁴

Notes:

1. Operation of this device above any one of these parameters may cause permanent damage.
2. Case Temperature = 25°C.
3. Derate at 3 mW/°C for T_{CASE} > 86°C.
4. The small spot size of this technique results in a higher, though more accurate determination of θ_{jc} than do alternate methods. See MEASUREMENTS section for more information.

Typical Performance, T_A = 25°C

(unless otherwise noted)

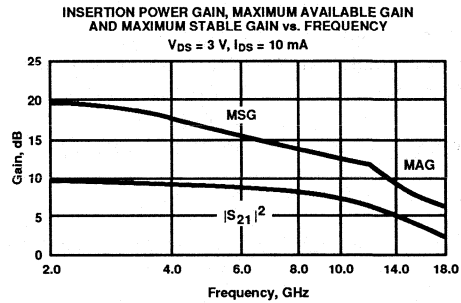

OPTIMUM NOISE FIGURE AND ASSOCIATED GAIN vs. FREQUENCY
 V_{DS} = 3 V, I_{DS} = 10 mA

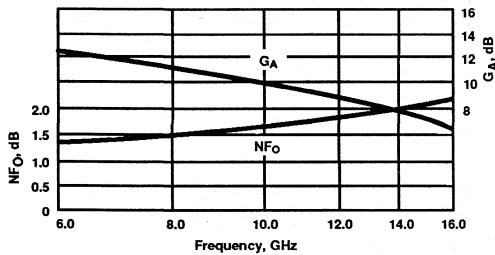

OPTIMUM NOISE FIGURE AND ASSOCIATED GAIN vs. I_{DS}
 V_{DS} = 3 V, f = 12.0 GHz

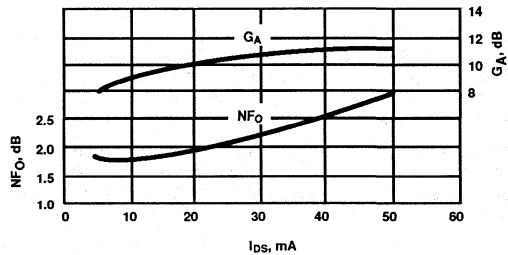

Typical Scattering Parameters: Common Source, Z₀ = 50 Ω

T_A = 25°C, V_{DS} = 3 V, I_{DS} = 10 mA

Freq. GHz	S ₁₁		S ₂₁			S ₁₂			S ₂₂	
	Mag	Ang	dB	Mag	Ang	dB	Mag	Ang	Mag	Ang
2.0	.96	-35	8.7	2.73	153	-28.0	.040	73	.76	-20
3.0	.93	-50	8.4	2.64	139	-26.2	.049	62	.72	-29
4.0	.91	-64	8.1	2.54	122	-24.7	.058	51	.68	-38
5.0	.88	-79	7.7	2.42	105	-23.5	.067	40	.64	-47
6.0	.85	-94	7.2	2.30	89	-22.4	.076	29	.60	-56
7.0	.81	-110	7.1	2.27	75	-21.4	.085	18	.56	-65
8.0	.76	-129	7.0	2.25	60	-20.3	.097	7	.51	-75
9.0	.73	-147	6.8	2.20	44	-19.4	.107	-3	.46	-89
10.0	.69	-164	6.5	2.11	27	-19.2	.110	-14	.44	-105
11.0	.67	-178	5.9	1.98	14	-19.1	.111	-20	.41	-123
12.0	.64	-166	5.7	1.93	-1	-19.0	.112	-30	.39	-137
13.0	.62	151	5.3	1.85	-15	-18.9	.114	-32	.37	-152
14.0	.59	135	5.1	1.81	-29	-18.7	.116	-46	.34	-173
15.0	.56	120	4.5	1.68	-43	-18.6	.117	-54	.35	160
16.0	.54	109	3.8	1.55	-58	18.5	.119	-67	.41	137
17.0	.51	99	3.1	1.43	-71	18.4	.120	-72	.46	125
18.0	.48	86	2.3	1.31	-85	18.1	.125	-77	.51	114

A model for this device is available in the DEVICE MODELS section.

Features

- **Low Noise Figure: 2.3 dB typical at 12 GHz**
- **High Associated Gain: 8.0 dB typical at 12 GHz**
- **High Output Power: 18.0 dBm typical P_{1 dB} at 12 GHz**
- **Hermetic Gold-Ceramic Microstrip Package**

Description

Avantek's ATF-26350 is a high performance gallium arsenide Schottky-barrier-gate field effect transistor housed in a hermetic, high reliability package. Its noise figure makes this device appropriate for use in low noise amplifiers operating in the 2-16 GHz frequency range.

This GaAs FET device has a nominal 0.3 micron gate length with a total gate periphery of 250 microns. Proven gold based metallization systems and nitride passivation assure a rugged, reliable device.

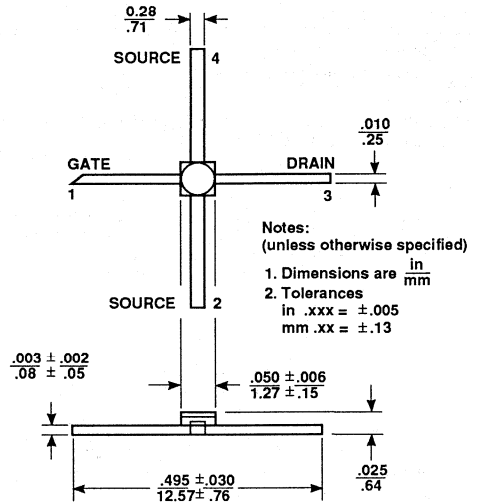
Avantek 50 mil Package

Noise Parameters: V_{DS} = 3 V, I_{DS} = 10 mA

Freq. GHz	NFO dB	Gamma Mag	Opt Ang	R _N /50
6.0	1.8	.49	82	.72
8.0	2.0	.50	118	.52
12.0	2.3	.55	-165	.13
14.0	2.5	.72	-119	.96

Electrical Specifications, T_A = 25°C

Symbol	Parameters and Test Conditions	Units	Min.	Typ.	Max.
NFO	Optimum Noise Figure: V _{DS} = 3 V, I _{DS} = 10 mA	f = 8.0 GHz dB f = 12.0 GHz dB f = 14.0 GHz dB		2.0 2.3 2.5	2.5
GA	Gain @ NFO: V _{DS} = 3 V, I _{DS} = 10 mA	f = 8.0 GHz dB f = 12.0 GHz dB f = 14.0 GHz dB	7.0	11.0 8.0 7.0	
P _{1 dB}	Output Power @ 1 dB Gain Compression: V _{DS} = 5 V, I _{DS} = 30 mA	f = 14.0 GHz		18.0	
G _{1 dB}	1 dB Compressed Gain: V _{DS} = 5 V, I _{DS} = 30 mA	f = 14.0 GHz		8.0	
g _m	Transconductance: V _{DS} = 3 V, V _{GS} = 0 V	mmho	20	40	
I _{DSS}	Saturated Drain Current: V _{DS} = 3 V, V _{GS} = 0 V	mA	25	50	90
V _P	Pinchoff Voltage: V _{DS} = 3 V, I _{DS} = 1 mA	V	-3.0	-1.7	-0.8

ATF-26350, 2-16 GHz General Purpose Gallium Arsenide FET

Absolute Maximum Ratings

Parameter	Symbol	Absolute Maximum ¹
Drain-Source Voltage	V _{DS}	+7 V
Gate-Source Voltage	V _{GS}	-4 V
Drain Current	I _{DS}	I _{DSS}
Power Dissipation ^{2,3}	P _T	275 mW
Channel Temperature	T _{CH}	175°C
Storage Temperature	T _{STG}	-65°C to +175°C

Thermal Resistance: $\theta_{jc} = 325^\circ\text{C/W}$; T_{CH} = 150°C
Liquid Crystal Measurement; 1 μm Spot Size⁴

Notes:

- Operation of this device above any one of these parameters may cause permanent damage.
- Case Temperature = 25°C.
- Derate at 3 mW/°C for T_{CASE} > 86°C.
- The small spot size of this technique results in a higher, though more accurate determination of θ_{jc} than do alternate methods. See MEASUREMENTS section for more information.

Typical Performance, T_A = 25°C

(unless otherwise noted)

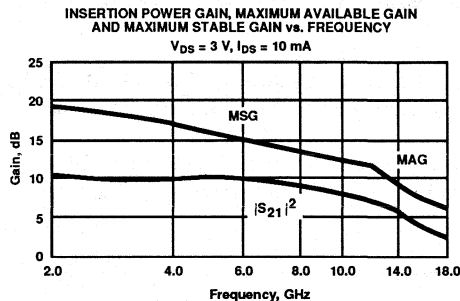

OPTIMUM NOISE FIGURE AND ASSOCIATED GAIN vs. FREQUENCY
V_{DS} = 3 V, I_{DS} = 10 mA

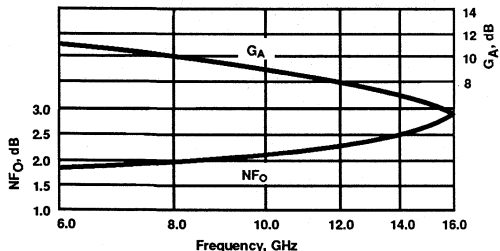

OPTIMUM NOISE FIGURE AND ASSOCIATED GAIN vs. I_{DS}
V_{DS} = 3 V, f = 12.0 GHz

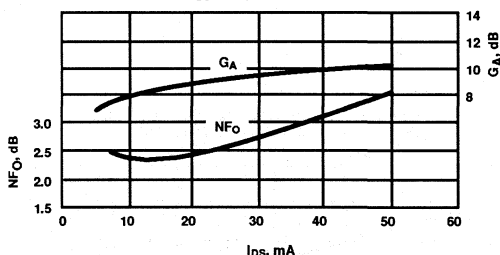

Typical Scattering Parameters: Common Source, Z₀ = 50 Ω

T_A = 25°C, V_{DS} = 3 V, I_{DS} = 10 mA

Freq. GHz	S ₁₁		dB	S ₂₁		dB	S ₁₂		S ₂₂	
	Mag	Ang		Mag	Ang		Mag	Ang	Mag	Ang
2.0	.94	-38	10.2	3.24	145	-27.3	.043	59	.76	-22
3.0	.88	-56	10.0	3.18	129	-25.4	.054	49	.73	-30
4.0	.86	-73	9.9	3.12	113	-23.9	.064	37	.70	-41
5.0	.81	-91	9.7	3.06	97	-22.5	.075	27	.66	-51
6.0	.77	-108	9.5	3.00	81	-21.4	.085	19	.63	-62
7.0	.71	-129	9.3	2.92	65	-20.1	.099	9	.58	-72
8.0	.65	-153	9.0	2.82	48	-19.3	.109	-6	.52	-83
9.0	.63	-176	8.6	2.68	31	-18.9	.114	-19	.48	-96
10.0	.62	164	7.8	2.45	14	-18.7	.116	-23	.44	-112
11.0	.61	148	7.0	2.25	0	-18.8	.115	-29	.42	-128
12.0	.61	130	6.5	2.12	-14	-18.9	.113	-36	.40	-140
13.0	.60	114	6.0	1.99	-28	-19.2	.110	-49	.39	-152
14.0	.60	98	5.5	1.88	-42	-19.3	.108	-57	.36	-171
15.0	.60	85	4.7	1.71	-56	-19.5	.106	-63	.36	165
16.0	.59	73	3.9	1.57	-69	-19.3	.108	-73	.40	141
17.0	.59	65	3.2	1.44	-81	-19.2	.110	-79	.45	131
18.0	.58	54	2.5	1.33	-95	-18.8	.115	-85	.49	123

A model for this device is available in the DEVICE MODELS section.

Features

- High Associated Gain: 8.0 dB typical at 12 GHz
- High Output Power: 18.0 dBm typical $P_{1\text{ dB}}$ at 12 GHz
- Low Noise Figure: 2.5 dB typical at 12 GHz
- Hermetic Gold-Ceramic Microstrip Package

Description

Avantek's ATF-26550 is a high performance gallium arsenide Schottky-barrier-gate field effect transistor housed in a hermetic, high reliability package. Its noise figure makes this device appropriate for use in the gain stages of low noise amplifiers operating in the 2-16 GHz frequency range.

This GaAs FET device has a nominal 0.3 micron gate length with a total gate periphery of 250 microns. Proven gold based metallization systems and nitride passivation assure a rugged, reliable device.

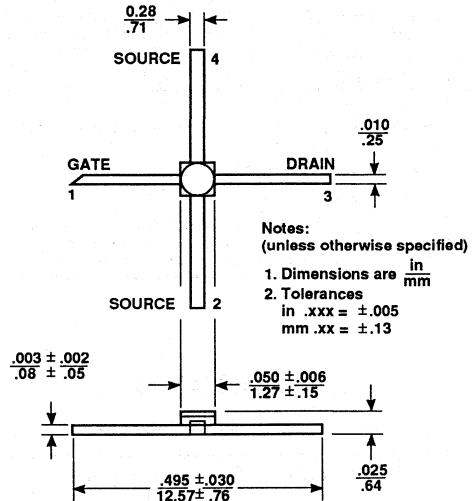
Avantek 50 mil Package

INSERTION POWER GAIN, MAXIMUM AVAILABLE GAIN AND MAXIMUM STABLE GAIN vs. FREQUENCY
 $V_{DS} = 3\text{ V}$, $I_{DS} = 10\text{ mA}$, $T_A = 25^\circ\text{C}$

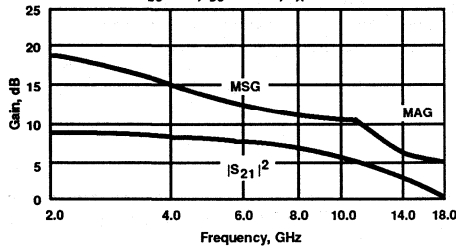
Electrical Specifications, $T_A = 25^\circ\text{C}$

Symbol	Parameters and Test Conditions	Units	Min.	Typ.	Max.
NFO	Optimum Noise Figure: $V_{DS} = 3\text{ V}$, $I_{DS} = 10\text{ mA}$				
GA	Gain @ NFO: $V_{DS} = 3\text{ V}$, $I_{DS} = 10\text{ mA}$	$f = 8.0\text{ GHz}$		2.2	2.8
		$f = 12.0\text{ GHz}$		2.5	
		$f = 14.0\text{ GHz}$		2.7	
$P_{1\text{ dB}}$	Output Power @ 1 dB Gain Compression: $V_{DS} = 5\text{ V}$, $I_{DS} = 30\text{ mA}$	$f = 8.0\text{ GHz}$		10.0	
		$f = 12.0\text{ GHz}$	7.0	8.0	
		$f = 14.0\text{ GHz}$		7.0	
$G_{1\text{ dB}}$	1 dB Compressed Gain: $V_{DS} = 5\text{ V}$, $I_{DS} = 30\text{ mA}$			7.5	
g_m	Transconductance: $V_{DS} = 3\text{ V}$, $V_{GS} = 0\text{ V}$	mmho	20	40	
I_{DSS}	Saturated Drain Current: $V_{DS} = 3\text{ V}$, $V_{GS} = 0\text{ V}$	mA	25	50	90
V_p	Pinchoff Voltage: $V_{DS} = 3\text{ V}$, $I_{DS} = 1\text{ mA}$	V	-3.0	-1.7	-0.8

ATF-26550, 2-16 GHz
General Purpose Gallium Arsenide FET

Absolute Maximum Ratings

Parameter	Symbol	Absolute Maximum ¹
Drain-Source Voltage	V _{DS}	+7 V
Gate-Source Voltage	V _{GS}	-4 V
Drain Current	I _{DS}	I _{DSS}
Power Dissipation ^{2,3}	P _T	275 mW
Channel Temperature	T _{CH}	175°C
Storage Temperature	T _{STG}	-65°C to +175°C

Thermal Resistance: $\theta_{jc} = 325^\circ\text{C/W}$; T_{CH} = 150°C
Liquid Crystal Measurement; 1 μm Spot Size⁴

Notes:

1. Operation of this device above any one of these parameters may cause permanent damage.
2. Case Temperature = 25°C.
3. Derate at 3 mW/°C for T_{CASE} > 86°C.
4. The small spot size of this technique results in a higher, though more accurate determination of θ_{jc} than do alternate methods. See MEASUREMENTS section for more information.

Typical Performance, T_A = 25°C

(unless otherwise noted)

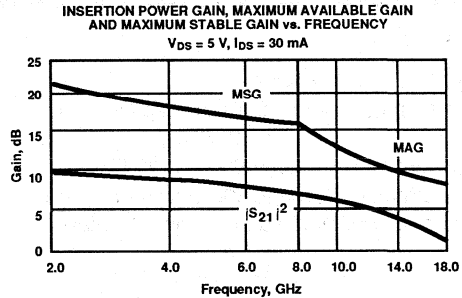

Typical Scattering Parameters: Common Source, Z₀ = 50 Ω

T_A = 25°C, V_{DS} = 3 V, I_{DS} = 10 mA

Freq. GHz	S ₁₁		S ₂₁			S ₁₂			S ₂₂	
	Mag	Ang	dB	Mag	Ang	dB	Mag	Ang	Mag	Ang
2.0	.95	-36	8.1	2.53	148	-28.0	.040	64	.75	-18
3.0	.92	-51	7.6	2.41	133	-24.7	.058	55	.71	-26
4.0	.90	-67	7.2	2.30	118	-22.4	.076	43	.68	-39
5.0	.87	-82	6.8	2.18	102	-20.5	.094	34	.64	-49
6.0	.84	-97	6.3	2.06	87	-19.0	.112	24	.60	-58
7.0	.80	-118	6.4	2.08	70	-18.2	.123	7	.55	-71
8.0	.73	-140	6.2	2.04	53	-17.4	.135	-5	.47	-85
9.0	.71	-161	5.8	1.95	35	-17.0	.142	-17	.43	-103
10.0	.67	-178	5.2	1.81	18	-16.7	.146	-27	.42	-120
11.0	.66	167	4.4	1.66	5	-16.8	.144	-39	.41	-134
12.0	.64	150	4.0	1.59	-10	-17.1	.140	-49	.40	-144
13.0	.63	133	3.6	1.51	-23	-17.4	.135	-59	.38	-154
14.0	.63	115	3.0	1.42	-38	-17.5	.133	-66	.36	-172
15.0	.62	99	2.5	1.34	-53	-17.7	.130	-74	.35	-158
16.0	.62	89	1.7	1.22	-67	-17.9	.128	-88	.40	134
17.0	.63	81	1.0	1.11	-79	-17.9	.127	-91	.44	123
18.0	.62	70	0.1	1.01	-92	-17.8	.129	-94	.48	118

T_A = 25°C, V_{DS} = 5 V, I_{DS} = 30 mA

2.0	.96	-38	9.0	2.82	144	-32.8	.023	69	.75	-20
3.0	.92	-52	8.4	2.62	130	-30.2	.031	70	.75	-28
4.0	.89	-66	7.9	2.48	116	-27.5	.042	68	.76	-36
5.0	.85	-82	7.8	2.46	100	-25.4	.054	65	.76	-47
6.0	.78	-102	7.7	2.43	84	-24.0	.063	46	.71	-57
7.0	.71	-124	7.5	2.38	66	-23.9	.064	30	.66	-68
8.0	.68	-144	7.2	2.30	52	-23.6	.066	25	.63	-78
9.0	.64	-163	7.0	2.23	37	-23.2	.069	19	.62	-86
10.0	.62	-178	6.4	2.08	21	-23.2	.069	12	.61	-99
11.0	.60	165	5.7	1.93	8	-23.1	.070	5	.61	-112
12.0	.60	149	5.2	1.82	-6	-23.1	.070	-3	.60	-124
13.0	.59	131	4.7	1.71	-21	-23.1	.070	-8	.60	-138
14.0	.59	122	4.1	1.60	-34	-22.5	.075	-15	.60	-152
15.0	.62	105	3.3	1.47	-48	-21.9	.080	-20	.59	-162
16.0	.61	93	3.0	1.42	-60	-21.5	.084	-25	.58	175
17.0	.62	83	2.2	1.29	-74	-21.1	.088	-31	.60	161
18.0	.63	73	1.1	1.13	-85	-20.3	.097	-40	.65	145

A model for this device is available in the DEVICE MODELS section.

Features

- High f_{MAX} : 60 GHz typical
- High Output Power: 18.0 dBm typical $P_{1\text{ dB}}$ at 12 GHz
- High Gain: 9.0 dB typical G_{SS} at 12 GHz
- Cost Effective Ceramic Microstrip Package
- Tape-and-Reel Packaging Option Available²

Description

Avantek's ATF-26836 is a high performance gallium arsenide Schottky-barrier-gate field effect transistor housed in a cost effective microstrip package. This device is designed for use in oscillator applications up to 25 GHz and general purpose amplifier applications in the 2-16 GHz frequency range.

This GaAs FET device has a nominal 0.3 micron gate length with a total gate periphery of 250 microns. Proven gold based metallization systems and nitride passivation assure a rugged, reliable device.

Avantek 36 micro-X Package¹

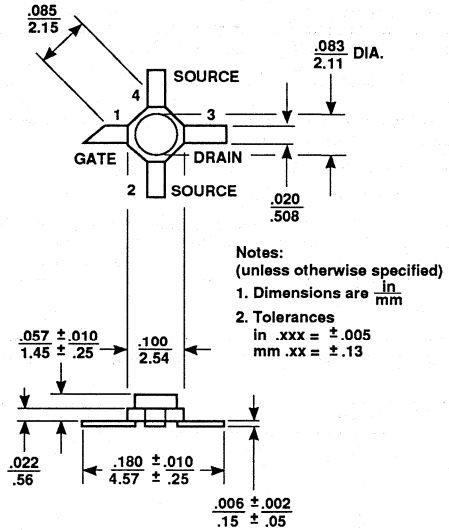

INSERTION POWER GAIN, MAXIMUM AVAILABLE GAIN AND MAXIMUM STABLE GAIN vs. FREQUENCY
 $V_{DS} = 5\text{ V}$, $I_{DS} = 30\text{ mA}$, $T_A = 25^\circ\text{C}$

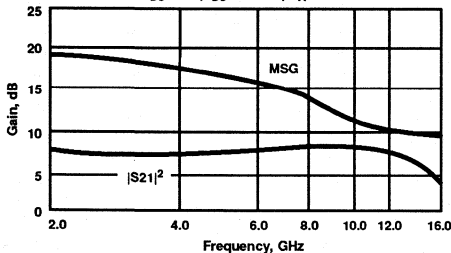

Electrical Specifications, $T_A = 25^\circ\text{C}$

Symbol	Parameters and Test Conditions	Units	Min.	Typ.	Max.
f_{MAX}	Maximum Frequency of Oscillation: $V_{DS} = 5\text{ V}$, $I_{DS} = 30\text{ mA}$	GHz		60	
G_{SS}	Tuned Small Signal Gain: $V_{DS} = 5\text{ V}$, $I_{DS} = 30\text{ mA}$	dB	7.0	9.0	
$P_{1\text{ dB}}$	Output Power @ 1 dB Gain Compression: $V_{DS} = 5\text{ V}$, $I_{DS} = 30\text{ mA}$	dBm	15.0	18.0	
NFO	Optimum Noise Figure: $V_{DS} = 3\text{ V}$, $I_{DS} = 10\text{ mA}$	dB		2.2	
G_A	Gain @ NFO: $V_{DS} = 3\text{ V}$, $I_{DS} = 10\text{ mA}$	dB		6.0	
g_m	Transconductance: $V_{DS} = 3\text{ V}$, $V_{GS} = 0\text{ V}$	mmho	15	35	
I_{DSS}	Saturated Drain Current: $V_{DS} = 3\text{ V}$, $V_{GS} = 0\text{ V}$	mA	20	50	100
V_p	Pinchoff Voltage: $V_{DS} = 3\text{ V}$, $I_{DS} = 1\text{ mA}$	V	-3.5	-1.5	-0.5

Notes: 1. Long leaded 36 micro-X package available upon request.
 2. Refer to PACKAGING section "Tape-and-Reel Packaging for Surface Mount Semiconductors".

Absolute Maximum Ratings

Parameter	Symbol	Absolute Maximum ¹
Drain-Source Voltage	V _{DS}	+7 V
Gate-Source Voltage	V _{GS}	-4 V
Drain Current	I _{DS}	I _{DSS}
Total Power Dissipation ^{2,3}	P _T	275 mW
Channel Temperature	T _{CH}	175°C
Storage Temperature ⁴	T _{STG}	-65°C to +175°C

Thermal Resistance: $\theta_{jc} = 350^\circ\text{C/W}$; T_{CH} = 150°C
 Liquid Crystal Measurement; 1 μm Spot Size⁵

Notes:

1. Operation of this device above any one of these parameters may cause permanent damage.
2. Case Temperature = 25°C.
3. Derate at 2.9 mW/°C for T_{CASE} > 79°C.
4. Storage above +150°C may tarnish the leads of this package difficult to solder into a circuit. After a device has been soldered into a circuit, it may be safely stored up to 175°C.
5. The small spot size of this technique results in a higher, though more accurate determination of θ_{jc} than do alternate methods. See MEASUREMENTS section for more information.

Part Number Ordering Information

Part Number	Devices Per Reel	Reel Size
ATF-26836-TR1	1000	7"
ATF-26836-TR2	4000	13"
ATF-26836-STR	1	STRIP

Typical Performance, T_A = 25°C

(unless otherwise noted)

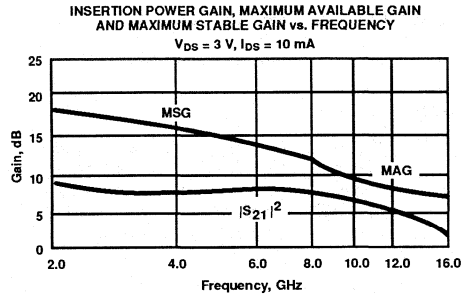

Typical Scattering Parameters: Common Emitter, Z₀ = 50 Ω

T_A = 25°C, V_{DS} = 3 V, I_{DS} = 10 mA

Freq. GHz	S ₁₁		S ₂₁			S ₁₂		S ₂₂			K
	Mag	Ang	dB	Mag	Ang	dB	Mag	Ang	Mag	Ang	
2.0	.94	-38	8.2	2.57	138	-27.1	.044	60	.74	-26	0.39
3.0	.90	-55	7.8	2.45	120	-24.9	.057	51	.71	-35	0.51
4.0	.84	-72	7.6	2.41	102	-22.9	.072	44	.71	-44	0.59
5.0	.75	-92	8.0	2.50	82	-20.6	.093	30	.66	-53	0.76
6.0	.64	-117	8.1	2.55	61	-19.3	.109	15	.60	-64	0.91
7.0	.52	-155	8.3	2.60	37	-18.1	.124	5	.51	-78	0.98
8.0	.49	163	7.9	2.47	14	-17.5	.133	-12	.41	-92	1.05
9.0	.52	126	7.2	2.30	-7	-16.9	.143	-21	.30	-106	1.07
10.0	.56	100	6.4	2.10	-28	-16.8	.144	-32	.24	-125	1.11
11.0	.61	78	5.6	1.91	-47	-17.1	.140	-41	.18	-154	1.16
12.0	.67	58	4.7	1.71	-66	-17.1	.139	-49	.15	168	1.16
13.0	.69	45	3.9	1.57	-83	-17.3	.137	-61	.17	134	1.20
14.0	.72	35	3.0	1.42	-98	-17.2	.138	-66	.19	107	1.20
15.0	.72	22	2.5	1.33	-115	-17.2	.138	-77	.23	89	1.24
16.0	.72	13	2.0	1.26	-128	-17.4	.135	-85	.27	71	1.31

T_A = 25°C, V_{DS} = 5 V, I_{DS} = 30 mA

2.0	.94	-44	9.0	2.82	130	-30.2	.031	65	.80	-31	0.28
3.0	.86	-63	8.5	2.65	110	-28.4	.038	56	.80	-43	0.49
4.0	.78	-81	8.0	2.51	89	-26.9	.045	47	.79	-52	0.72
5.0	.68	-97	7.9	2.49	71	-25.5	.053	41	.78	-58	0.89
6.0	.57	-118	8.1	2.53	51	-24.4	.060	39	.76	-67	0.98
7.0	.43	-151	8.5	2.65	28	-22.4	.076	38	.73	-80	0.90
8.0	.37	165	8.5	2.66	3	-20.6	.093	30	.69	-99	0.82
9.0	.40	122	8.0	2.52	-20	-18.0	.126	15	.64	-119	0.67
10.0	.47	96	7.7	2.42	-42	-16.4	.152	3	.66	-140	0.47
11.0	.55	75	7.5	2.37	-66	-15.1	.176	-4	.63	-166	0.39
12.0	.61	53	7.4	2.35	-88	-13.8	.205	-19	.64	168	0.30
13.0	.71	33	7.4	2.34	-116	-13.2	.220	-39	.71	132	0.11
14.0	.71	10	6.7	2.17	-143	-13.5	.212	-56	.78	104	0.06
15.0	.65	-10	5.7	1.93	-170	-14.0	.200	-72	.85	79	0.04
16.0	.58	-30	4.2	1.62	166	-14.9	.180	-93	.98	61	-0.23

A model for this device is available in the DEVICE MODELS section.

Features

- High f_{MAX} : 60 GHz typical
- High Output Power: 18.0 dBm typical $P_{1\text{ dB}}$ at 12 GHz
- High Gain: 9.0 dB typical G_{SS} at 12 GHz
- Low Cost Plastic Package
- Tape-and-Reel Packaging Option Available¹

Description

Avantek's ATF-26884 is a high performance gallium arsenide Schottky-barrier-gate field effect transistor housed in a low cost effective plastic package. This device is designed for use in oscillator applications up to 25 GHz and general purpose amplifier applications in the 2-16 GHz frequency range.

This GaAs FET device has a nominal 0.3 micron gate length with a total gate periphery of 250 microns. Proven gold based metallization systems and nitride passivation assure a rugged, reliable device.

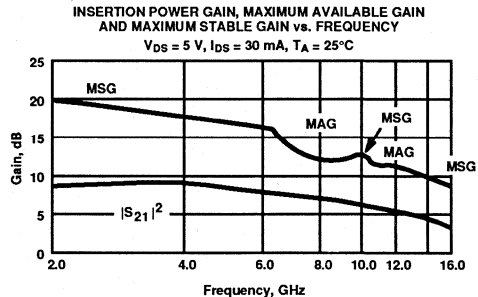
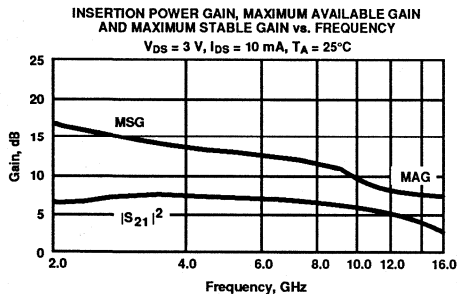
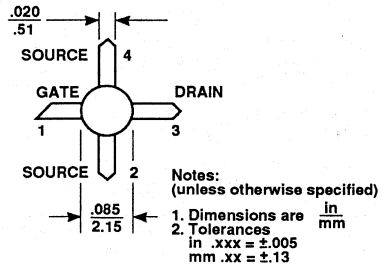
Avantek 84 Plastic Package

Electrical Specifications, $T_A = 25^\circ\text{C}$

Symbol	Parameters and Test Conditions	Units	Min.	Typ.	Max.
f_{MAX}	Maximum Frequency of Oscillation: $V_{DS} = 5\text{ V}$, $I_{DS} = 30\text{ mA}$	GHz		60	
G_{SS}	Tuned Small Signal Gain: $V_{DS} = 5\text{ V}$, $I_{DS} = 30\text{ mA}$ $f = 12.0\text{ GHz}$	dB	7.0	9.0	
$P_{1\text{ dB}}$	Output Power @ 1 dB Gain Compression: $V_{DS} = 5\text{ V}$, $I_{DS} = 30\text{ mA}$ $f = 12.0\text{ GHz}$	dBm	15.0	18.0	
N_{FO}	Optimum Noise Figure: $V_{DS} = 3\text{ V}$, $I_{DS} = 10\text{ mA}$ $f = 12.0\text{ GHz}$	dB		2.2	
G_A	Gain @ NFO: $V_{DS} = 3\text{ V}$, $I_{DS} = 10\text{ mA}$ $f = 12.0\text{ GHz}$	dB		6.0	
g_m	Transconductance: $V_{DS} = 3\text{ V}$, $V_{GS} = 0\text{ V}$	mmho	15	35	
I_{DSS}	Saturated Drain Current: $V_{DS} = 3\text{ V}$, $V_{GS} = 0\text{ V}$	mA	20	50	100
V_p	Pinchoff Voltage: $V_{DS} = 3\text{ V}$, $I_{DS} = 1\text{ mA}$	V	-3.5	-1.5	-0.5

Note: 1. Refer to PACKAGING section "Tape-and-Reel Packaging for Surface Mount Semiconductors".

ATF-26884, 2-16 GHz
General Purpose Gallium Arsenide FET

Absolute Maximum Ratings

Parameter	Symbol	Absolute Maximum ¹
Drain-Source Voltage	V _{DS}	+7 V
Gate-Source Voltage	V _{GS}	-4 V
Drain Current	I _{DS}	I _{DSS}
Total Power Dissipation ^{2,3}	P _T	275 mW
Channel Temperature	T _{CH}	175°C
Storage Temperature	T _{STG}	-65°C to +150°C

Thermal Resistance: $\theta_{jC} = 300^{\circ}\text{C}/\text{W}$; T_{CH} = 150°C
 Liquid Crystal Measurement; 1 μm Spot Size⁴

Notes:

1. Operation of this device above any one of these parameters may cause permanent damage.
2. Case Temperature = 25°C.
3. Derate at 3.3 mW/°C for T_C > 92.5°C.
4. The small spot size of this technique results in a higher, though more accurate determination of θ_{jC} than do alternate methods. See MEASUREMENTS section for more information.

Part Number Ordering Information

Part Number	Devices Per Reel	Reel Size
ATF-26884-TR1	1000	7"
ATF-26884-TR2	4000	13"
ATF-26884-STR	1	STRIP

Typical Scattering Parameters: Common Source, Z₀ = 50 Ω

T_A = 25°C, V_{DS} = 3 V, I_{DS} = 10 mA

Freq. GHz	S ₁₁		S ₂₁			S ₁₂			S ₂₂			K
	Mag	Ang	dB	Mag	Ang	dB	Mag	Ang	Mag	Ang		
2.0	.96	-36	6.9	2.21	142	-26.6	.047	64	.81	-25	0.22	
3.0	.91	-56	7.4	2.35	123	-23.0	.071	50	.77	-38	0.33	
4.0	.86	-78	7.6	2.39	103	-20.6	.093	36	.70	-50	0.44	
5.0	.79	-97	7.2	2.30	86	-19.5	.106	25	.66	-61	0.57	
6.0	.73	-113	6.8	2.20	71	-18.9	.114	16	.62	-70	0.70	
7.0	.67	-127	6.4	2.10	56	-18.4	.120	9	.61	-78	0.81	
8.0	.62	-144	6.4	2.08	41	-17.9	.128	1	.58	-88	0.88	
9.0	.57	-168	6.2	2.03	23	-17.5	.134	-8	.54	-101	0.94	
10.0	.53	168	5.8	1.96	6	-17.3	.136	-16	.47	-116	1.07	
11.0	.52	147	5.2	1.81	-10	-17.2	.138	-22	.41	-133	1.19	
12.0	.49	124	4.9	1.76	-22	-17.1	.140	-26	.39	-143	1.26	
13.0	.52	103	4.6	1.70	-36	-16.7	.146	-31	.37	-154	1.21	
14.0	.56	80	4.0	1.58	-54	-16.3	.153	-37	.35	-171	1.17	
15.0	.60	65	3.3	1.46	-72	-16.3	.153	-42	.35	173	1.16	
16.0	.65	52	2.9	1.40	-83	-16.3	.153	-48	.37	132	1.10	
17.0	.68	40	2.3	1.30	-99	-16.0	.158	-56	.41	101	1.07	
18.0	.69	30	1.3	1.16	-112	-15.9	.159	-72	.47	87	1.03	

T_A = 25°C, V_{DS} = 5 V, I_{DS} = 30 mA

2.0	.94	-41	9.2	2.88	138	-30.8	.029	65	.84	-23	0.29
3.0	.87	-65	9.5	2.97	118	-27.3	.043	51	.80	-34	0.43
4.0	.79	-89	9.3	2.93	97	-25.5	.053	40	.74	-44	0.63
5.0	.71	-109	8.7	2.73	79	-24.9	.057	35	.71	-53	0.82
6.0	.64	-126	8.1	2.54	64	-24.4	.060	33	.69	-60	0.99
7.0	.57	-142	7.5	2.38	50	-24.0	.063	31	.69	-67	1.12
8.0	.52	-162	7.2	2.30	35	-23.1	.070	30	.69	-76	1.07
9.0	.48	174	6.9	2.21	18	-21.9	.080	28	.67	-87	1.05
10.0	.48	149	6.5	2.11	1	-20.4	.095	24	.63	-100	0.98
11.0	.48	130	5.9	1.97	-14	-19.7	.104	22	.57	-114	1.10
12.0	.49	108	5.6	1.91	-25	-18.1	.125	20	.55	-122	0.96
13.0	.53	88	5.2	1.82	-39	-16.2	.155	18	.54	-132	0.78
14.0	.57	69	4.7	1.71	-55	-15.2	.173	5	.52	-146	0.72
15.0	.62	56	4.1	1.60	-75	-14.8	.182	-1	.52	-165	0.65
16.0	.70	44	3.7	1.53	-87	-13.8	.205	-16	.52	165	0.51
17.0	.75	33	3.0	1.41	-103	-12.9	.226	-28	.54	135	0.45
18.0	.74	24	2.3	1.30	-117	-13.6	.210	-44	.63	114	0.41

A model for this device is available in the DEVICE MODELS section.

Features

- **High Output Power:**
32.0 dBm typical $P_{1\text{ dB}}$ at 4 GHz
- **High Gain at 1 dB Compression:**
9.0 dB typical $G_{1\text{ dB}}$ at 4 GHz
- **High Power Efficiency:**
36% typical at 4 GHz

Description

The ATF-44100 is a gallium arsenide Schottky-barrier-gate field effect transistor designed for medium power, linear amplification in the 2 to 8 GHz frequency range. This nominally 0.5 micron gate length GaAs FET is an interdigitated four-cell structure using airbridge interconnects between source fingers. Total gate periphery is 5 millimeters. Proven gold based metallization systems and nitride passivation assure a rugged, reliable device.

The recommended mounting procedure is to die attach at a stage temperature of 300° C using a gold-tin preform under forming gas. Assembly should be performed with wedge bonding using either 0.7 mil of 1.0 mil gold wire. See also "Chip Use" in the APPLICATIONS section.

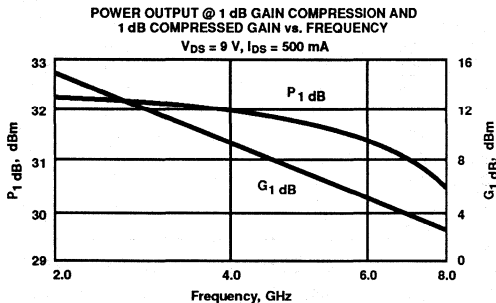
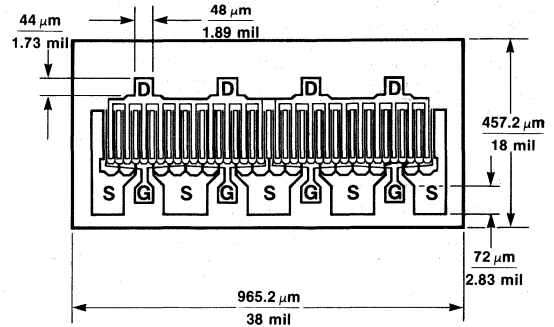
Avantek Chip Outline

Electrical Specifications, $T_A = 25^\circ\text{C}$

Symbol	Parameters and Test Conditions ¹	Units	Min.	Typ.	Max.
$P_{1\text{ dB}}$	Output Power @ 1 dB Gain Compression: $V_{DS} = 9\text{ V}, I_{DS} = 500\text{ mA}$	f = 4.0 GHz f = 6.0 GHz f = 8.0 GHz		32.0 31.5 31.0	
$G_{1\text{ dB}}$	1 dB Compressed Gain: $V_{DS} = 9\text{ V}, I_{DS} = 500\text{ mA}$	f = 4.0 GHz f = 6.0 GHz f = 8.0 GHz	8.0	9.0 6.0 3.0	
η_{add}	Efficiency @ $P_{1\text{ dB}}$: $V_{DS} = 9\text{ V}, I_{DS} = 500\text{ mA}$	f = 4.0 GHz		36	
g_m	Transconductance: $V_{DS} = 2.5\text{ V}, I_{DS} = 500\text{ mA}$			300	
I_{DSS}	Saturated Drain Current: $V_{DS} = 1.75\text{ V}, V_{GS} = 0\text{ V}$		800	1300	1500
V_p	Pinchoff Voltage: $V_{DS} = 2.5\text{ V}, I_{DS} = 5\text{ mA}$		-5.4	-4.5	-2.0

Note: 1. RF Performance is determined by assembling and testing 10 samples per wafer.

Absolute Maximum Ratings

Parameter	Symbol	Absolute Maximum ¹
Drain-Source Voltage	V _{DS}	+14 V
Gate-Source Voltage	V _{GS}	-7 V
Drain Current	I _{DS}	I _{DSS}
Power Dissipation ^{2,3}	P _T	8.3 mW
Channel Temperature	T _{CH}	175°C
Storage Temperature	T _{STG}	-65°C to +175°C

Thermal Resistance: $\theta_{JC} = 18^\circ\text{C/W}$; T_{CH} = 150°C
Liquid Crystal Measurement; 1 μm Spot Size⁴

Notes:

1. Operation of this device above any one of these parameters may cause permanent damage.
2. Mounting Surface Temperature = 25°C.
3. Derate at 55.6 mW/°C for T_{MOUNTING SURFACE} > 26°C.
4. The small spot size of this technique results in a higher, though more accurate determination of θ_{JC} than do alternate methods. See MEASUREMENTS section for more information.

Part Number Ordering Information

Part Number	Devices Per Tray
ATF-44100-GP1	5
ATF-44100-GP3	50
ATF-44100-GP6	up to 300

Typical Performance, T_A = 25°C

(unless otherwise noted)

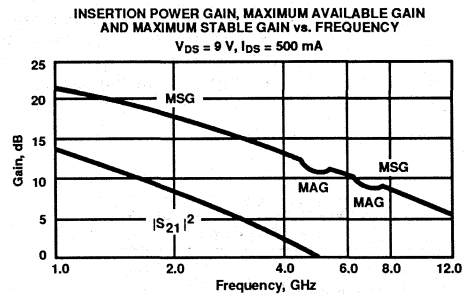
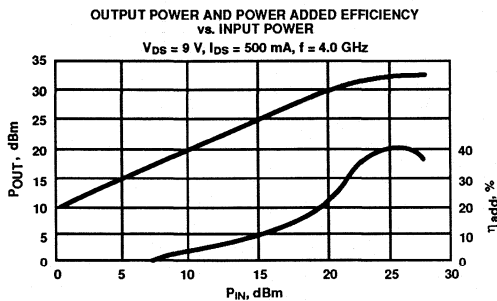

Typical Scattering Parameters: Common Source, Z₀ = 50 Ω

T_A = 25°C, V_{DS} = 9 V, I_{DS} = 500 mA

Freq. GHz	S ₁₁		S ₂₁			S ₁₂			S ₂₂	
	Mag	Ang	dB	Mag	Ang	dB	Mag	Ang	Mag	Ang
1.0	.88	-117	13.1	4.52	111	-28.0	.040	34	.37	-162
2.0	.89	-149	8.1	2.55	88	-26.0	.050	36	.41	-168
3.0	.89	-163	5.1	1.80	72	-25.4	.054	38	.44	-170
4.0	.90	-172	2.4	1.32	60	-24.7	.058	44	.47	-173
5.0	.91	-179	0.3	1.04	49	-24.3	.061	46	.52	-176
6.0	.92	175	-1.4	.85	39	-23.5	.067	47	.56	-178
7.0	.92	170	-3.2	.69	30	-23.0	.071	49	.60	180
8.0	.93	167	-4.4	.60	24	-22.6	.074	50	.64	176
9.0	.93	162	-5.7	.52	15	-22.2	.078	51	.67	175
10.0	.94	158	-6.7	.46	10	-21.7	.082	52	.70	173
11.0	.95	153	-7.7	.41	3	-21.3	.086	50	.73	172
12.0	.95	145	-9.1	.35	-4	-20.7	.092	49	.76	171

A model for this device is available in the DEVICE MODELS section.

Features

- **High Output Power:**
32.0 dBm typical $P_{1\text{ dB}}$ at 4 GHz
- **High Gain at 1 dB Compression:**
9.0 dB typical $G_{1\text{ dB}}$ at 4 GHz
- **High Power Efficiency:**
36% typical at 4 GHz
- **Hermetic Metal-Ceramic Stripline Package**

Description

The ATF-44101 is a gallium arsenide Schottky-barrier-gate field effect transistor designed for medium power, linear amplification in the 2 to 8 GHz frequency range. This nominally .5 micron gate length GaAs FET is an interdigitated four-cell structure using airbridge interconnects between source fingers. Total gate periphery is 5 millimeters. Proven gold based metallization systems and nitride passivation assure a rugged, reliable device.

This device is suitable for applications in space, airborne, military ground and shipboard, and commercial environments. It is supplied in a hermetic high reliability package with low parasitic reactance and minimum thermal resistance.

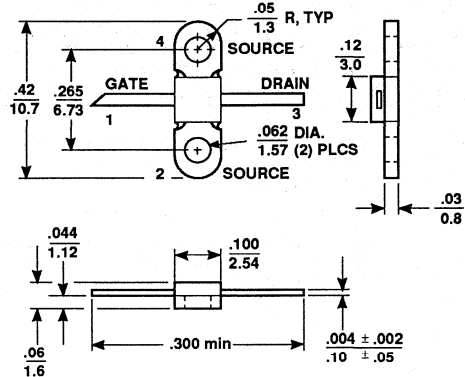
Avantek 100 mil Flange

- Notes:
(unless otherwise specified)
1. Dimensions are in mm
 2. Tolerances
in .xxx = ±.005
mm .xx = ±.13

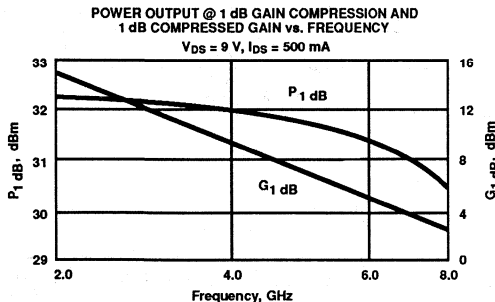
Electrical Specifications, $T_A = 25^\circ\text{C}$

Symbol	Parameters and Test Conditions	Units	Min.	Typ.	Max.
$P_{1\text{ dB}}$	Output Power @ 1 dB Gain Compression: $V_{DS} = 9\text{ V}$, $I_{DS} = 500\text{ mA}$	dBm	31.0	32.0 31.5	
$G_{1\text{ dB}}$	1 dB Compressed Gain: $V_{DS} = 9\text{ V}$, $I_{DS} = 500\text{ mA}$	dB	8.0	9.0 5.5	
η_{add}	Efficiency @ $P_{1\text{ dB}}$: $V_{DS} = 9\text{ V}$, $I_{DS} = 500\text{ mA}$	%		36	
g_m	Transconductance: $V_{DS} = 2.5\text{ V}$, $I_{DS} = 500\text{ mA}$	mmho		300	
I_{DSS}	Saturated Drain Current: $V_{DS} = 1.75\text{ V}$, $V_{GS} = 0\text{ V}$	mA	800	1300	1500
V_p	Pinchoff Voltage: $V_{DS} = 2.5\text{ V}$, $I_{DS} = 5\text{ mA}$	V	-5.4	-4.0	-2.0

Absolute Maximum Ratings

Parameter	Symbol	Absolute Maximum ¹
Drain-Source Voltage	V _{DS}	+14 V
Gate-Source Voltage	V _{GS}	-7 V
Drain Current	I _{DS}	I _{DSS}
Power Dissipation ^{2,3}	P _T	6.5 mW
Channel Temperature	T _{CH}	175°C
Storage Temperature	T _{STG}	-65°C to +175°C

Thermal Resistance: $\theta_{jc} = 23^\circ\text{C/W}$; T_{CH} = 150°C
Liquid Crystal Measurement; 1 μm Spot Size⁴

Notes:

1. Operation of this device above any one of these parameters may cause permanent damage.
2. Case Temperature = 25°C.
3. Derate at 43 mW/°C for T_{CASE} > 25°C.
4. The small spot size of this technique results in a higher, though more accurate determination of θ_{jc} than do alternate methods. See MEASUREMENTS section for more information.

Typical Performance, T_A = 25°C

(unless otherwise noted)

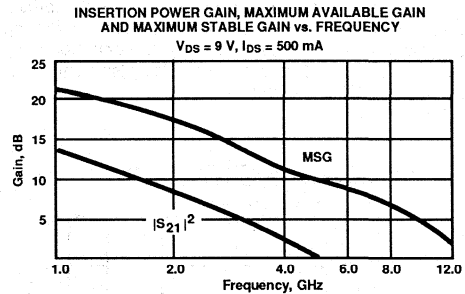
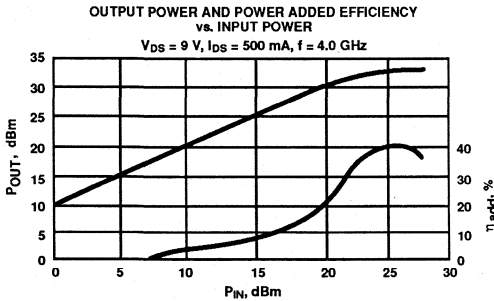

Typical Scattering Parameters: Common Source, Z₀ = 50 Ω

T_A = 25°C, V_{DS} = 9 V, I_{DS} = 500 mA

Freq. GHz	S ₁₁		S ₂₁			S ₁₂			S ₂₂	
	Mag	Ang	dB	Mag	Ang	dB	Mag	Ang	Mag	Ang
1.0	.88	-125	13.4	4.69	104	-28.2	.039	31	.29	-154
2.0	.87	-161	8.1	2.53	74	-26.7	.046	21	.38	-164
3.0	.87	-178	4.8	1.73	54	-26.7	.046	22	.44	-167
4.0	.87	168	2.5	1.34	35	-25.7	.052	17	.47	-175
5.0	.88	153	0.8	1.10	16	-25.5	.053	13	.49	175
6.0	.88	136	-0.8	.91	-5	-23.6	.066	0	.52	160
7.0	.89	122	-2.5	.75	-25	-23.4	.068	-7	.56	144
8.0	.89	114	-4.2	.62	-39	-22.7	.073	-13	.62	132
9.0	.88	109	-5.5	.53	-52	-22.2	.078	-18	.68	124
10.0	.86	103	-6.7	.46	-64	-20.9	.090	-24	.72	118
11.0	.81	91	-6.9	.45	-78	-19.3	.108	-33	.73	112
12.0	.77	74	-7.5	.42	-95	-17.2	.138	-49	.73	101

A model for this device is available in the DEVICE MODELS section.

Features

- **High Output Power:**
 29.0 dBm typical $P_{1\text{ dB}}$ at 4 GHz
- **High Gain at 1 dB Compression:**
 11.0 dB typical $G_{1\text{ dB}}$ at 4 GHz
- **High Power Efficiency:**
 38% typical at 4 GHz

Description

The ATF-45100 is a gallium arsenide Schottky-barrier-gate field effect transistor designed for medium power, linear amplification in the 2 to 12 GHz frequency range. This nominally 0.5 micron gate length GaAs FET is an interdigitated four-cell structure using airbridge interconnects between drain fingers. Total gate periphery is 2.5 millimeters. Proven gold based metallization systems and nitride passivation assure a rugged, reliable device. All metal surfaces are gold plated for ease of bonding and die attach.

The recommended mounting procedure is to die attach temperature of 300°C using a gold-tin preform under forming gas. Assembly should be performed with wedge bonding using either 0.7 mil of 1.0 mil gold wire. See also "Chip Use" in the APPLICATIONS section.

Avantek Chip Outline

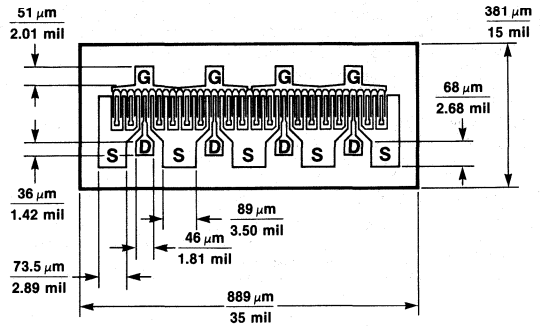

POWER OUTPUT @ 1 dB GAIN COMPRESSION and 1 dB COMPRESSED GAIN vs. FREQUENCY
 $V_{DS} = 9\text{ V}, I_{DS} = 250\text{ mA}$

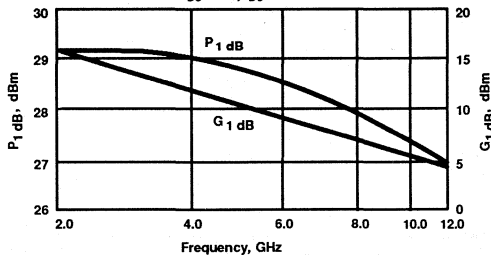

Electrical Specifications, $T_A = 25^\circ\text{C}$

Symbol	Parameters and Test Conditions ¹	Units	Min.	Typ.	Max.
$P_{1\text{ dB}}$	Output Power @ 1 dB Gain Compression: $V_{DS} = 9\text{ V}, I_{DS} = 250\text{ mA}$ $f = 4.0\text{ GHz}$ $f = 8.0\text{ GHz}$ $f = 12.0\text{ GHz}$	dBm	28.0	29.0 28.0 27.0	
$G_{1\text{ dB}}$	1 dB Compressed Gain: $V_{DS} = 9\text{ V}, I_{DS} = 250\text{ mA}$ $f = 4.0\text{ GHz}$ $f = 8.0\text{ GHz}$ $f = 12.0\text{ GHz}$	dB	10.0	11.0 6.5 4.5	
η_{add}	Efficiency @ $P_{1\text{ dB}}$: $V_{DS} = 9\text{ V}, I_{DS} = 250\text{ mA}$ $f = 4.0\text{ GHz}$	%		38	
g_m	Transconductance: $V_{DS} = 2.5\text{ V}, I_{DS} = 250\text{ mA}$	mmho		200	
I_{DSS}	Saturated Drain Current: $V_{DS} = 1.75\text{ V}, V_{GS} = 0\text{ V}$	mA	400	600	800
V_p	Pinchoff Voltage: $V_{DS} = 2.5\text{ V}, I_{DS} = 5\text{ mA}$	V	-5.4	-4.0	-2.0

Note: 1. RF Performance is determined by packaging and testing 10 samples per wafer.

Absolute Maximum Ratings

Parameter	Symbol	Absolute Maximum ¹
Drain-Source Voltage	V _{DS}	+14 V
Gate-Source Voltage	V _{GS}	-7 V
Drain Current	I _{DS}	I _{DSS}
Power Dissipation ^{2,3}	P _T	4.0 W
Channel Temperature	T _{CH}	175°C
Storage Temperature	T _{STG}	-65°C to +175°C

Thermal Resistance: $\theta_{jc} = 38^\circ\text{C/W}$; T_{CH} = 150°C
Liquid Crystal Measurement; 1 μm Spot Size⁴

Notes:

1. Operation of this device above any one of these parameters may cause permanent damage.
2. Mounting Surface Temperature = 25°C.
3. Derate at 26 mW/°C for T_{MOUNTING SURFACE} > 23°C.
4. The small spot size of this technique results in a higher, though more accurate determination of θ_{jc} than do alternate methods. See MEASUREMENTS section for more information.

Part Number Ordering Information

Part Number	Devices Per Tray
ATF-45100-GP1	5
ATF-45100-GP3	50
ATF-45100-GP6	up to 300

Typical Performance, T_A = 25°C

(unless otherwise noted)

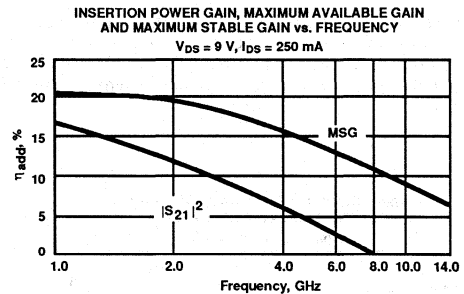
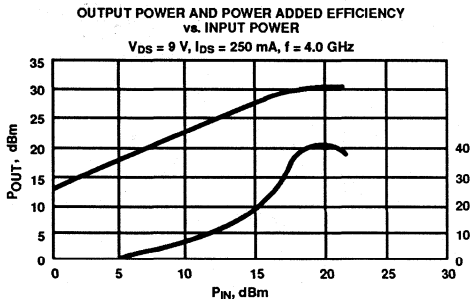

Typical Scattering Parameters: Common Source, Z₀ = 50 Ω

T_A = 25°C, V_{DS} = 9 V, I_{DS} = 250 mA

Freq. GHz	S ₁₁		dB	S ₂₁		dB	S ₁₂		S ₂₂	
	Mag	Ang		Mag	Ang		Mag	Ang	Mag	Ang
1.0	.92	-88	16.1	6.41	124	-27.3	.043	36	.32	-45
2.0	.85	-127	12.1	4.01	96	-26.0	.050	38	.29	-68
3.0	.84	-147	9.3	2.93	78	-25.4	.054	40	.29	-87
4.0	.85	-159	6.8	2.19	64	-24.9	.057	43	.31	-102
5.0	.87	-169	4.8	1.74	51	-24.3	.061	48	.37	-118
6.0	.88	-177	3.1	1.43	38	-23.9	.064	53	.43	-130
7.0	.88	177	1.3	1.17	27	-23.5	.067	57	.50	-139
8.0	.89	173	0.0	1.00	19	-22.4	.076	60	.57	-149
9.0	.90	167	-1.3	.86	8	-21.7	.082	63	.63	-157
10.0	.90	162	-2.6	.74	1	-21.2	.087	60	.68	-162
11.0	.91	157	-4.0	.63	-9	-20.4	.096	57	.72	-169
12.0	.91	148	-5.4	.54	-18	-19.9	.101	54	.75	-171
13.0	.90	145	-6.0	.50	-25	-19.6	.105	48	.79	-175
14.0	.90	135	-6.9	.45	-35	-19.7	.104	41	.82	-179

A model for this device is available in the DEVICE MODELS section.

Features

- **High Output Power:**
 29.0 dBm typical $P_{1\text{ dB}}$ at 4 GHz
- **High Gain at 1 dB Compression:**
 10.0 dB typical $G_{1\text{ dB}}$ at 4 GHz
- **High Power Efficiency:**
 38% typical at 4 GHz
- **Hermetic Metal-Ceramic Stripline Package**

Description

The ATF-45101 is a gallium arsenide Schottky-barrier-gate field effect transistor designed for medium power, linear amplification in the 2 to 8 GHz frequency range. This nominally 0.5 micron gate length GaAs FET is an interdigitated four-cell structure using airbridge interconnects between drain fingers. Total gate periphery is 2.5 millimeters. Proven gold based metalization systems and nitride passivation assure a rugged, reliable device.

This device is suitable for applications in space, airborne, military ground and shipboard, and commercial environments. It is supplied in a hermetic high reliability package with low parasitic reactance and minimum thermal resistance.

Avantek 100 mil Flange Package

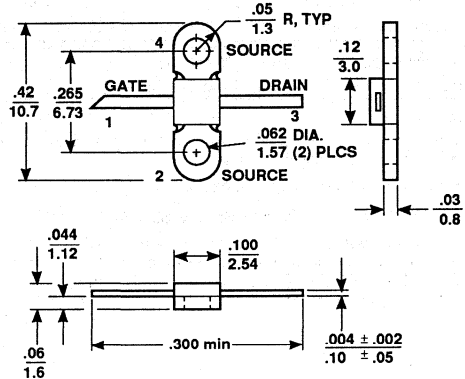

- Notes:**
 (unless otherwise specified)
1. Dimensions are in mm
 2. Tolerances in .xxx = ±.005
 mm .xx = ±.13

POWER OUTPUT @ 1 dB COMPRESSION and 1 dB COMPRESSED GAIN vs. FREQUENCY
 $V_{DS} = 9\text{ V}$, $I_{DS} = 250\text{ mA}$

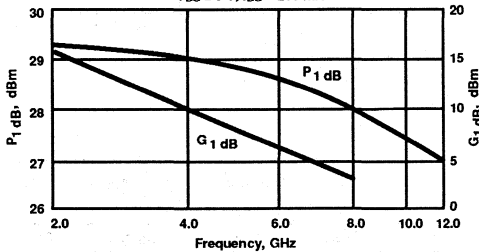

Electrical Specifications, $T_A = 25^\circ\text{C}$

Symbol	Parameters and Test Conditions	Units	Min.	Typ.	Max.
$P_{1\text{ dB}}$	Output Power @ 1 dB Gain Compression: $V_{DS} = 9\text{ V}$, $I_{DS} = 250\text{ mA}$	dBm	28.0	29.0	
$G_{1\text{ dB}}$	1 dB Compressed Gain: $V_{DS} = 9\text{ V}$, $I_{DS} = 250\text{ mA}$	dB	9.0	10.0	
η_{add}	Efficiency @ $P_{1\text{ dB}}$: $V_{DS} = 9\text{ V}$, $I_{DS} = 250\text{ mA}$	%		38	
g_m	Transconductance: $V_{DS} = 2.5\text{ V}$, $I_{DS} = 250\text{ mA}$	mmho		200	
I_{DSS}	Saturated Drain Current: $V_{DS} = 1.75\text{ V}$, $V_{GS} = 0\text{ V}$	mA	400	600	800
V_P	Pinchoff Voltage: $V_{DS} = 2.5\text{ V}$, $I_{DS} = 5\text{ mA}$	V	-5.4	-4.0	-2.0

Absolute Maximum Ratings

Parameter	Symbol	Absolute Maximum ¹
Drain-Source Voltage	V _{DS}	+14 V
Gate-Source Voltage	V _{GS}	-7 V
Drain Current	I _{DS}	I _{DSS}
Power Dissipation ^{2,3}	P _T	3.6 W
Channel Temperature	T _{CH}	175°C
Storage Temperature	T _{STG}	-65°C to +175°C

Thermal Resistance: $\theta_{jC} = 42^\circ\text{C/W}$; T_{CH} = 150°C
Liquid Crystal Measurement; 1 μm Spot Size⁴

Notes:

1. Operation of this device above any one of these parameters may cause permanent damage.
2. Case Temperature = 25°C.
3. Derate at 24 mW/°C for T_{CASE} > 24°C.
4. The small spot size of this technique results in a higher, though more accurate determination of θ_{jC} than do alternate methods. See MEASUREMENTS section for more information.

Typical Performance, T_A = 25°C

(unless otherwise noted)

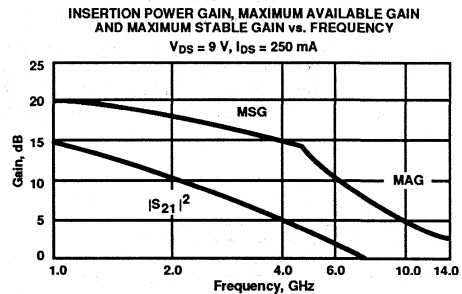
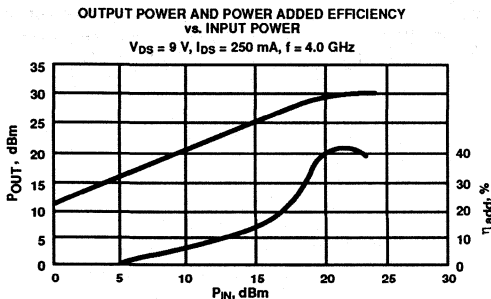

Typical Scattering Parameters: Common Source, Z₀ = 50 Ω

T_A = 25°C, V_{DS} = 9 V, I_{DS} = 250 mA

Freq. GHz	S ₁₁		S ₂₁			S ₁₂			S ₂₂	
	Mag	Ang	dB	Mag	Ang	dB	Mag	Ang	Mag	Ang
1.0	.89	-88	14.9	5.54	119	-26.2	.049	43	.31	-63
2.0	.83	-135	10.8	3.48	82	-26.0	.050	18	.33	-108
3.0	.81	-158	7.6	2.40	58	-25.8	.051	7	.39	-129
4.0	.84	-174	5.4	1.86	38	-25.5	.053	3	.46	-144
5.0	.82	170	3.8	1.55	18	-25.2	.055	-2	.50	-154
6.0	.81	152	2.6	1.36	-2	-24.4	.060	-8	.52	-168
7.0	.81	133	1.2	1.15	-25	-23.9	.064	-15	.55	173
8.0	.81	122	-0.3	.97	-42	-23.5	.067	-20	.59	154
9.0	.80	113	-1.8	.81	-60	-22.6	.074	-31	.64	137
10.0	.79	107	-3.2	.69	-73	-22.0	.079	-40	.68	123
11.0	.77	94	-4.6	.59	-91	-21.5	.084	-45	.72	113
12.0	.73	82	-5.8	.51	-106	-20.3	.097	-55	.76	99
13.0	.68	69	-6.7	.46	-123	-18.3	.121	-63	.78	89
14.0	.64	56	-7.1	.44	-137	-15.9	.161	-79	.80	79

A model for this device is available in the DEVICE MODELS section.

Features

- **High Output Power:**
29.0 dBm typical $P_{1\text{ dB}}$ at 4 GHz
- **High Gain at 1 dB Compression:**
10.5 dB typical $G_{1\text{ dB}}$ at 4 GHz
- **High Power Efficiency:**
38% typical at 4 GHz
- **Hermetic Metal-Ceramic Stripline Package**

Avantek 70 mil Flange Package

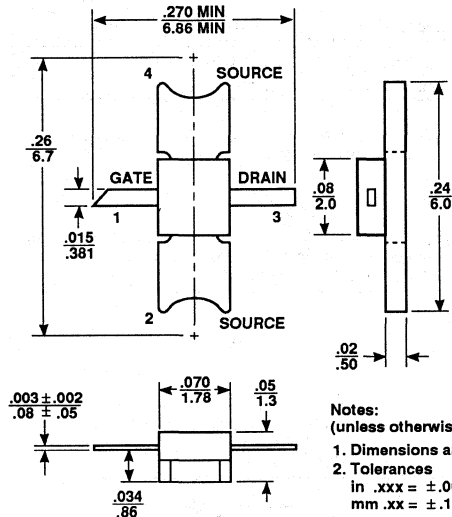

Description

The ATF-45171 is a gallium arsenide Schottky-barrier-gate field effect transistor designed for medium power, linear amplification in the 2 to 8 GHz frequency range. This nominally 0.5 micron gate length GaAs FET is an interdigitated four-cell structure using airbridge interconnects between drain fingers. Total gate periphery is 2.5 millimeters. Proven gold based metallization systems and nitride passivation assure a rugged, reliable device.

This device is suitable for applications in space, airborne, military ground and shipboard, and commercial environments. It is supplied in a hermetic high reliability package with low parasitic reactance and minimum thermal resistance.

POWER OUTPUT @ 1 dB COMPRESSION and 1 dB COMPRESSED GAIN vs. FREQUENCY
 $V_{DS} = 9\text{ V}$, $I_{DS} = 250\text{ mA}$

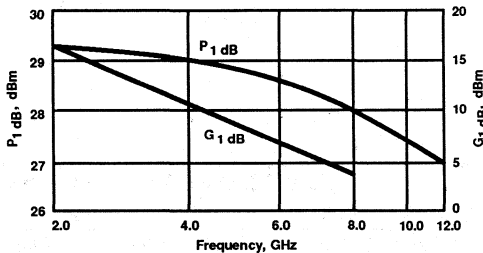

Electrical Specifications, $T_A = 25^\circ\text{C}$

Symbol	Parameters and Test Conditions	Units	Min.	Typ.	Max.
$P_{1\text{ dB}}$	Output Power @ 1 dB Gain Compression: $V_{DS} = 9\text{ V}$, $I_{DS} = 250\text{ mA}$	f = 4.0 GHz f = 8.0 GHz	dBm	28.0 28.0	29.0 28.0
$G_{1\text{ dB}}$	1 dB Compressed Gain: $V_{DS} = 9\text{ V}$, $I_{DS} = 250\text{ mA}$	f = 4.0 GHz f = 8.0 GHz	dB	9.5 4.5	10.5
η_{add}	Efficiency @ $P_{1\text{ dB}}$: $V_{DS} = 9\text{ V}$, $I_{DS} = 250\text{ mA}$	f = 4.0 GHz	%	38	
g_m	Transconductance: $V_{DS} = 2.5\text{ V}$, $I_{DS} = 250\text{ mA}$		mmho	200	
I_{DSS}	Saturated Drain Current: $V_{DS} = 1.75\text{ V}$, $V_{GS} = 0\text{ V}$		mA	400	600 800
V_p	Pinchoff Voltage: $V_{DS} = 2.5\text{ V}$, $I_{DS} = 5\text{ mA}$		V	-5.4	-4.0 -2.0

ATF-45171, 2-8 GHz Medium Power Gallium Arsenide FET

Absolute Maximum Ratings

Parameter	Symbol	Absolute Maximum ¹
Drain-Source Voltage	V _{DS}	+14 V
Gate-Source Voltage	V _{GS}	-7 V
Drain Current	I _{DS}	I _{DSS}
Power Dissipation ^{2,3}	P _T	3.6 W
Channel Temperature	T _{CH}	175°C
Storage Temperature	T _{STG}	-65°C to +175°C

Thermal Resistance: $\theta_{JC} = 42^\circ\text{C/W}$; T_{CH} = 150°C
Liquid Crystal Measurement; 1 μm Spot Size⁴

Notes:

- Operation of this device above any one of these parameters may cause permanent damage.
- Case Temperature = 25°C.
- Derate at 24 mW/°C for T_{CASE} > 24°C.
- The small spot size of this technique results in a higher, though more accurate determination of θ_{JC} than do alternate methods. See MEASUREMENTS section for more information.

Typical Performance, T_A = 25°C

(unless otherwise noted)

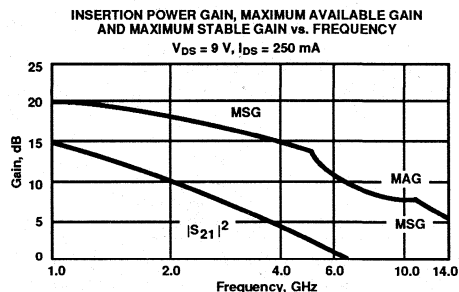
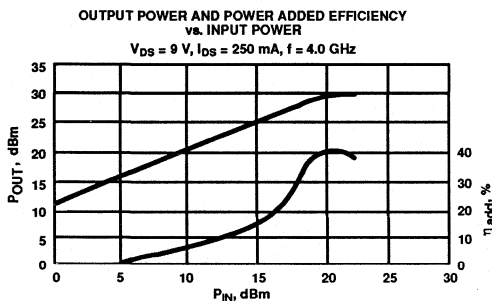

Typical Scattering Parameters: Common Source, Z₀ = 50 Ω

T_A = 25°C, V_{DS} = 9 V, I_{DS} = 250 mA

Freq. GHz	S ₁₁		S ₂₁			S ₁₂			S ₂₂	
	Mag	Ang	dB	Mag	Ang	dB	Mag	Ang	Mag	Ang
1.0	.91	-83	14.5	5.30	122	-26.7	.046	46	.37	-46
2.0	.83	-137	10.8	3.45	83	-26.4	.048	19	.26	-91
3.0	.83	-167	7.4	2.34	54	-26.0	.050	5	.31	-131
4.0	.86	174	4.4	1.66	32	-25.5	.053	2	.43	-155
5.0	.86	162	2.1	1.28	12	-25.1	.055	0	.52	-167
6.0	.85	152	0.7	1.09	-3	-24.7	.058	-2	.56	-176
7.0	.84	138	0.1	1.01	-22	-24.4	.060	-6	.59	173
8.0	.84	124	-0.9	.90	-40	-23.8	.064	-13	.62	154
9.0	.85	114	-2.5	.75	-59	-23.4	.068	-19	.66	135
10.0	.85	106	-4.3	.61	-70	-22.5	.075	-25	.71	123
11.0	.85	100	-5.2	.55	-81	-21.6	.083	-30	.76	119
12.0	.83	95	-6.2	.49	-90	-20.8	.091	-39	.79	111
13.0	.80	76	-6.7	.46	-107	-19.3	.109	-50	.81	98
14.0	.77	59	-8.0	.40	-125	-18.9	.113	-61	.83	78

A model for this device is available in the DEVICE MODELS section.

Features

- **High Output Power:**
27.0 dBm typical $P_{1\text{ dB}}$ at 4 GHz
- **High Gain at 1 dB Compression:**
12.0 dB typical $G_{1\text{ dB}}$ at 4 GHz
- **High Power Efficiency:**
38% typical at 4 GHz

Description

The ATF-46100 is a gallium arsenide Schottky-barrier-gate field effect transistor designed for medium power, linear amplification in the 2 to 14 GHz frequency range. This nominally 0.5 micron gate length GaAs FET is an interdigitated four-cell structure using airbridge interconnects between drain fingers. Total gate periphery is 1.25 millimeters. Proven gold based metallization systems and nitride passivation assure a rugged, reliable device. All metal surfaces are gold plated for ease of bonding and die attach.

The recommended mounting procedure is to die attach temperature of 300°C using a gold-tin preform under forming gas. Assembly should be performed with wedge bonding using either 0.7 mil of 1.0 mil gold wire. See also "Chip Use" in the APPLICATIONS section.

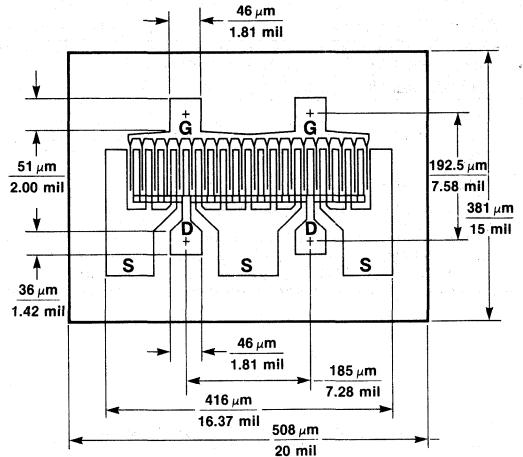
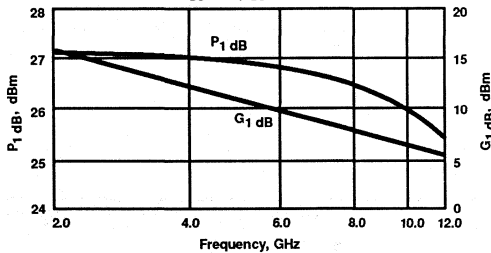
Avantek Chip Outline

POWER OUTPUT @ 1 dB COMPRESSION and 1 dB COMPRESSED GAIN vs. FREQUENCY
 $V_{DS} = 9\text{ V}$, $I_{DS} = 125\text{ mA}$

Electrical Specifications, $T_A = 25^\circ\text{C}$

Symbol	Parameters and Test Conditions ¹	Units	Min.	Typ.	Max.
$P_{1\text{ dB}}$	Output Power @ 1 dB Gain Compression: $V_{DS} = 9\text{ V}$, $I_{DS} = 125\text{ mA}$	dBm	26.0	27.0	
$G_{1\text{ dB}}$	1 dB Compressed Gain: $V_{DS} = 9\text{ V}$, $I_{DS} = 125\text{ mA}$	dB	11.0	12.0	
η_{add}	Efficiency @ $P_{1\text{ dB}}$: $V_{DS} = 9\text{ V}$, $I_{DS} = 125\text{ mA}$	%		38	
g_m	Transconductance: $V_{DS} = 2.5\text{ V}$, $I_{DS} = 125\text{ mA}$	mmho		100	
I_{DSS}	Saturated Drain Current: $V_{DS} = 2.5\text{ V}$, $V_{GS} = 0\text{ V}$	mA	200	330	450
V_P	Pinchoff Voltage: $V_{DS} = 2.5\text{ V}$, $I_{DS} = 5\text{ mA}$	V	-5.4	-3.5	-2.0

Note 1: RF Performance is determined by packaging and testing 10 samples per wafer.

ATF-46100, 2-14 GHz Medium Power Gallium Arsenide FET

Absolute Maximum Ratings

Parameter	Symbol	Absolute Maximum ¹
Drain-Source Voltage	V _{DS}	+14 V
Gate-Source Voltage	V _{GS}	-7 V
Drain Current	I _{DS}	100 mA
Power Dissipation ^{2,3}	P _T	2.2 W
Channel Temperature	T _{CH}	175°C
Storage Temperature	T _{STG}	-65°C to +175°C

Thermal Resistance: $\theta_{jc} = 70^\circ\text{C/W}$; T_{CH} = 150°C
Liquid Crystal Measurement; 1 μm Spot Size⁴

Notes:

- Operation of this device above any one of these parameters may cause permanent damage.
- Mounting Surface Temperature = 25°C.
- Derate at 14.3 mW/°C for T_{MOUNTING SURFACE} > 21°C.
- The small spot size of this technique results in a higher, though more accurate determination of θ_{jc} than do alternate methods. See MEASUREMENTS section for more information.

Part Number Ordering Information

Part Number	Devices Per Tray
ATF-46100-GP1	5
ATF-46100-GP3	50
ATF-46100-GP5	up to 300

Typical Performance, T_A = 25°C

(unless otherwise noted)

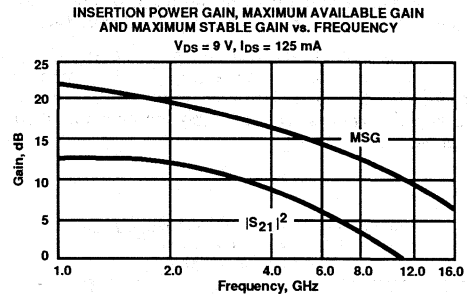
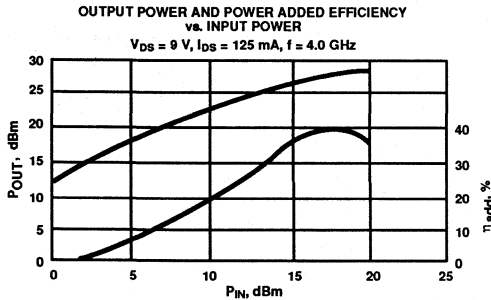

Typical Scattering Parameters: Common Source, Z₀ = 50 Ω

T_A = 25°C, V_{DS} = 9 V, I_{DS} = 250 mA

Freq. GHz	S ₁₁		S ₂₁			S ₁₂			S ₂₂	
	Mag	Ang	dB	Mag	Ang	dB	Mag	Ang	Mag	Ang
1.0	.97	-44	13.0	4.48	148	-30.8	.029	70	.60	-15
2.0	.89	-80	11.3	3.69	121	-27.1	.044	70	.56	-26
3.0	.84	-106	9.9	3.13	101	-25.5	.053	69	.51	-36
4.0	.81	-129	8.3	2.59	83	-24.4	.060	68	.47	-45
5.0	.81	-147	6.8	2.20	67	-23.9	.064	66	.45	-59
6.0	.82	-161	5.6	1.90	53	-23.5	.067	64	.42	-74
7.0	.83	-172	4.2	1.63	40	-22.9	.072	62	.42	-89
8.0	.84	180	3.3	1.46	29	-22.0	.079	60	.45	-105
9.0	.85	171	2.3	1.31	16	-20.8	.091	58	.49	-125
10.0	.86	163	1.0	1.12	4	-19.8	.102	56	.55	-139
11.0	.88	156	0.3	1.03	-7	-18.9	.113	54	.61	-154
12.0	.89	149	-1.0	.89	-18	-18.5	.119	51	.66	-162
13.0	.90	142	-2.0	.79	-26	-17.7	.130	42	.72	-172
14.0	.91	135	-3.2	.69	-38	-17.4	.135	39	.76	180
15.0	.92	130	-4.3	.61	-45	-16.9	.143	33	.79	175
16.0	.93	126	-5.4	.54	-51	-16.4	.151	24	.82	167

A model for this device is available in the DEVICE MODELS section.

Features

- **High Output Power:**
27.0 dBm typical $P_{1\text{ dB}}$ at 4 GHz
- **High Gain at 1 dB Compression:**
10.0 dB typical $G_{1\text{ dB}}$ at 4 GHz
- **High Power Efficiency:**
38% typical at 4 GHz
- **Hermetic Metal-Ceramic Stripline Package**

Description

The ATF-46101 is a gallium arsenide Schottky-barrier-gate field effect transistor designed for medium power, linear amplification in the 2 to 10 GHz frequency range. This nominally 0.5 micron gate length GaAs FET is an interdigitated four-cell structure using airbridge interconnects between drain fingers. Total gate periphery is 1.25 millimeters. Proven gold based metallization systems and nitride passivation assure a rugged, reliable device.

This device is suitable for applications in space, airborne, military ground and shipboard, and commercial environments. It is supplied in a hermetic high reliability package with low parasitic reactance and minimum thermal resistance.

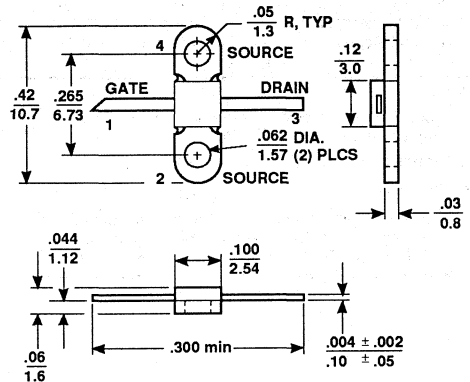
Avantek 100 mil Flange Package

- Notes:
(unless otherwise specified)
1. Dimensions are in mm
2. Tolerances
in .xxx = ±.005
mm .xx = ±.13

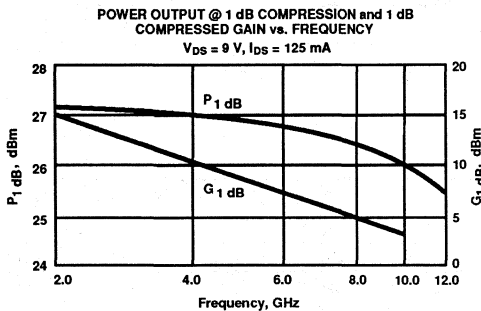
Electrical Specifications, $T_A = 25^\circ\text{C}$

Symbol	Parameters and Test Conditions	Units	Min.	Typ.	Max.
$P_{1\text{ dB}}$	Output Power @ 1 dB Gain Compression: $V_{DS} = 9\text{ V}$, $I_{DS} = 125\text{ mA}$	f = 4.0 GHz f = 8.0 GHz	26.0	27.0 26.5	
$G_{1\text{ dB}}$	1 dB Compressed Gain: $V_{DS} = 9\text{ V}$, $I_{DS} = 125\text{ mA}$	f = 4.0 GHz f = 8.0 GHz	9.0	10.0 5.0	
η_{add}	Efficiency @ $P_{1\text{ dB}}$: $V_{DS} = 9\text{ V}$, $I_{DS} = 125\text{ mA}$	f = 4.0 GHz		38	
g_m	Transconductance: $V_{DS} = 2.5\text{ V}$, $I_{DS} = 125\text{ mA}$			100	
I_{DSS}	Saturated Drain Current: $V_{DS} = 2.5\text{ V}$, $V_{GS} = 0\text{ V}$		200	330	450
V_p	Pinchoff Voltage: $V_{DS} = 2.5\text{ V}$, $I_{DS} = 5\text{ mA}$		-5.4	-3.5	-2.0

Absolute Maximum Ratings

Parameter	Symbol	Absolute Maximum ¹
Drain-Source Voltage	V _{DS}	+14 V
Gate-Source Voltage	V _{GS}	-7 V
Drain Current	I _{DS}	I _{DSS}
Power Dissipation ^{2,3}	P _T	2.0 W
Channel Temperature	T _{CH}	175°C
Storage Temperature	T _{STG}	-65°C to +175°C

Thermal Resistance: $\theta_{jC} = 75^\circ\text{C/W}$; T_{CH} = 150°C
Liquid Crystal Measurement; 1 μm Spot Size⁴

Notes:

1. Operation of this device above any one of these parameters may cause permanent damage.
2. Case Temperature = 25°C.
3. Derate at 13 mW/°C for T_{CASE} > 25°C.
4. The small spot size of this technique results in a higher, though more accurate determination of θ_{jC} than do alternate methods. See MEASUREMENTS section for more information.

Typical Performance, T_A = 25°C

(unless otherwise noted)

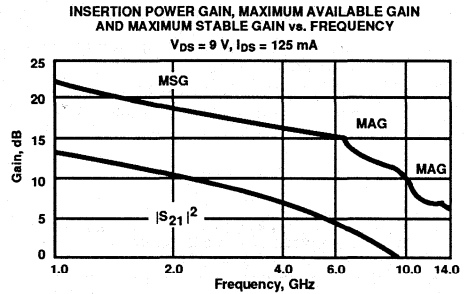
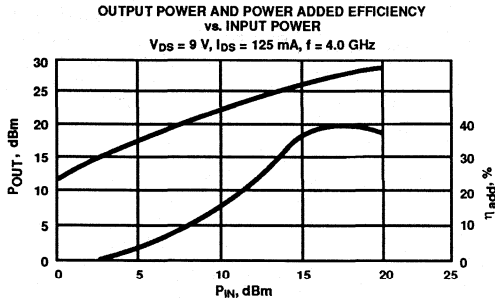

Typical Scattering Parameters: Common Source, Z₀ = 50 Ω

T_A = 25°C, V_{DS} = 9 V, I_{DS} = 125 mA

Freq. GHz	S ₁₁		S ₂₁			S ₁₂			S ₂₂	
	Mag	Ang	dB	Mag	Ang	dB	Mag	Ang	Mag	Ang
1.0	.94	-56	12.8	4.37	135	-31.4	.027	52	.64	-28
2.0	.86	-101	10.7	3.41	98	-27.3	.043	30	.59	-56
3.0	.82	-131	8.4	2.64	71	-26.9	.045	18	.58	-79
4.0	.82	-152	6.7	2.16	48	-26.4	.048	9	.62	-98
5.0	.80	-173	5.4	1.86	26	-26.0	.050	-1	.63	-112
6.0	.79	165	4.3	1.64	5	-25.8	.051	-12	.65	-126
7.0	.78	143	3.1	1.43	-18	-25.4	.054	-24	.65	-145
8.0	.78	131	1.6	1.20	-36	-24.7	.058	-37	.70	-166
9.0	.77	123	0.3	1.03	-55	-23.9	.064	-40	.73	173
10.0	.76	118	-1.2	.87	-72	-23.1	.070	-52	.76	158
11.0	.67	104	-2.0	.79	-91	-22.6	.074	-57	.79	146
12.0	.60	86	-2.7	.73	-110	-21.2	.087	-66	.83	136
13.0	.54	71	-3.5	.67	-133	-19.7	.104	-79	.87	124
14.0	.50	64	-4.0	.63	-154	-15.9	.160	-99	.92	115

A model for this device is available in the DEVICE MODELS section.

Features

- **High Output Power:**
27.0 dBm typical $P_{1\text{ dB}}$ at 4 GHz
- **High Gain at 1 dB Compression:**
11.0 dB typical $G_{1\text{ dB}}$ at 4 GHz
- **High Power Efficiency:**
38% typical at 4 GHz
- **Hermetic Metal-Ceramic Stripline Package**

Description

The ATF-46171 is a gallium arsenide Schottky-barrier-gate field effect transistor designed for medium power, linear amplification in the 2 to 10 GHz frequency range. This nominally 0.5 micron gate length GaAs FET is an interdigitated four-cell structure using airbridge interconnects between drain fingers. Total gate periphery is 1.25 millimeters. Proven gold based metallization systems and nitride passivation assure a rugged, reliable device.

This device is suitable for applications in space, airborne, military ground and shipboard, and commercial environments. It is supplied in a hermetic high reliability package with low parasitic reactance and minimum thermal resistance.

Avantek 70 mil Flange Package

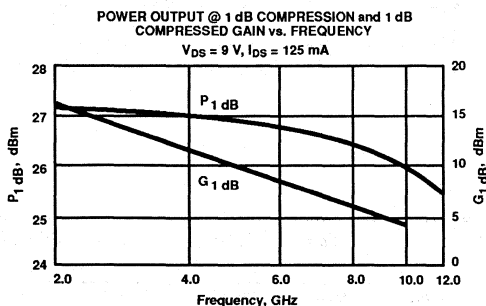
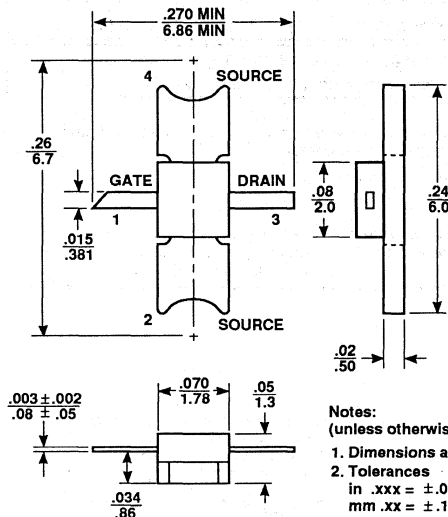

Electrical Specifications, $T_A = 25^\circ\text{C}$

Symbol	Parameters and Test Conditions	Units	Min.	Typ.	Max.
$P_{1\text{ dB}}$	Output Power @ 1 dB Gain Compression: $V_{DS} = 9\text{ V}, I_{DS} = 125\text{ mA}$	$f = 4.0\text{ GHz}$ $f = 8.0\text{ GHz}$	26.0	27.0 26.5	
$G_{1\text{ dB}}$	1 dB Compressed Gain: $V_{DS} = 9\text{ V}, I_{DS} = 125\text{ mA}$	$f = 4.0\text{ GHz}$ $f = 8.0\text{ GHz}$	10.0	11.0 6.0	
η_{add}	Efficiency @ $P_{1\text{ dB}}$: $V_{DS} = 9\text{ V}, I_{DS} = 125\text{ mA}$	$f = 4.0\text{ GHz}$		38	
g_m	Transconductance: $V_{DS} = 2.5\text{ V}, I_{DS} = 125\text{ mA}$			100	
I_{DSS}	Saturated Drain Current: $V_{DS} = 2.5\text{ V}, V_{GS} = 0\text{ V}$		200	330	450
V_p	Pinchoff Voltage: $V_{DS} = 2.5\text{ V}, I_{DS} = 5\text{ mA}$		-5.4	-3.5	-2.0

ATF-46171, 2-10 GHz Medium Power Gallium Arsenide FET

Absolute Maximum Ratings

Parameter	Symbol	Absolute Maximum ¹
Drain-Source Voltage	V _{DS}	+14 V
Gate-Source Voltage	V _{GS}	-7 V
Drain Current	I _{DS}	I _{DSS}
Power Dissipation ^{2,3}	P _T	2.0 W
Channel Temperature	T _{CH}	175°C
Storage Temperature	T _{STG}	-65°C to +175°C

Thermal Resistance: $\theta_{JC} = 75^\circ\text{C/W}$; T_{CH} = 150°C
Liquid Crystal Measurement; 1 μm Spot Size⁴

Notes:

- Operation of this device above any one of these parameters may cause permanent damage.
- Case Temperature = 25°C.
- Derate at 13 mW/°C for T_{CASE} > 25°C.
- The small spot size of this technique results in a higher, though more accurate determination of θ_{JC} than do alternate methods. See MEASUREMENTS section for more information.

Typical Performance, T_A = 25°C

(unless otherwise noted)

OUTPUT POWER AND POWER ADDED EFFICIENCY
vs. INPUT POWER

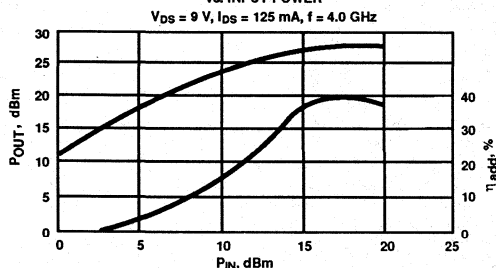

INSERTION POWER GAIN, MAXIMUM AVAILABLE GAIN
AND MAXIMUM STABLE GAIN vs. FREQUENCY

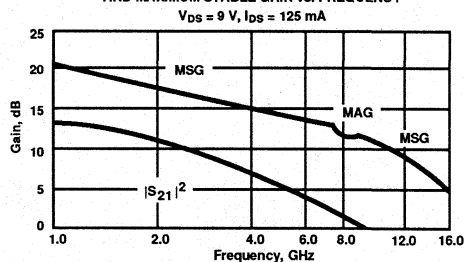

Typical Scattering Parameters: Common Source, Z₀ = 50 Ω

T_A = 25°C, V_{DS} = 9 V, I_{DS} = 125 mA

Freq. GHz	S ₁₁		S ₂₁			S ₁₂			S ₂₂	
	Mag	Ang	dB	Mag	Ang	dB	Mag	Ang	Mag	Ang
1.0	.95	-54	12.7	4.30	138	-29.4	.034	63	.71	-22
2.0	.84	-106	11.0	3.56	99	-26.7	.046	30	.60	-44
3.0	.81	-145	8.9	2.80	67	-25.7	.052	13	.52	-71
4.0	.81	-172	6.6	2.14	40	-25.0	.056	2	.52	-101
5.0	.80	171	4.6	1.70	18	-24.4	.060	-3	.58	-122
6.0	.79	159	3.1	1.44	1	-24.0	.063	-6	.63	-135
7.0	.78	141	2.2	1.29	-18	-23.5	.067	-10	.63	-147
8.0	.77	123	1.4	1.17	-36	-23.0	.071	-14	.64	-164
9.0	.79	108	-0.1	.99	-58	-22.5	.075	-17	.67	171
10.0	.79	100	-1.4	.85	-73	-22.0	.079	-21	.74	152
11.0	.78	93	-2.5	.75	-86	-21.6	.083	-24	.76	142
12.0	.76	85	-3.5	.67	-97	-20.6	.093	-32	.79	133
13.0	.73	67	-4.3	.61	-118	-19.5	.106	-49	.80	119
14.0	.71	47	-5.8	.51	-138	-19.0	.112	-66	.83	98
15.0	.73	35	-7.5	.42	-157	-18.6	.118	-71	.85	83
16.0	.75	26	-8.9	.36	-157	-18.3	.121	-78	.90	72

A model for this device is available in the DEVICE MODELS section.

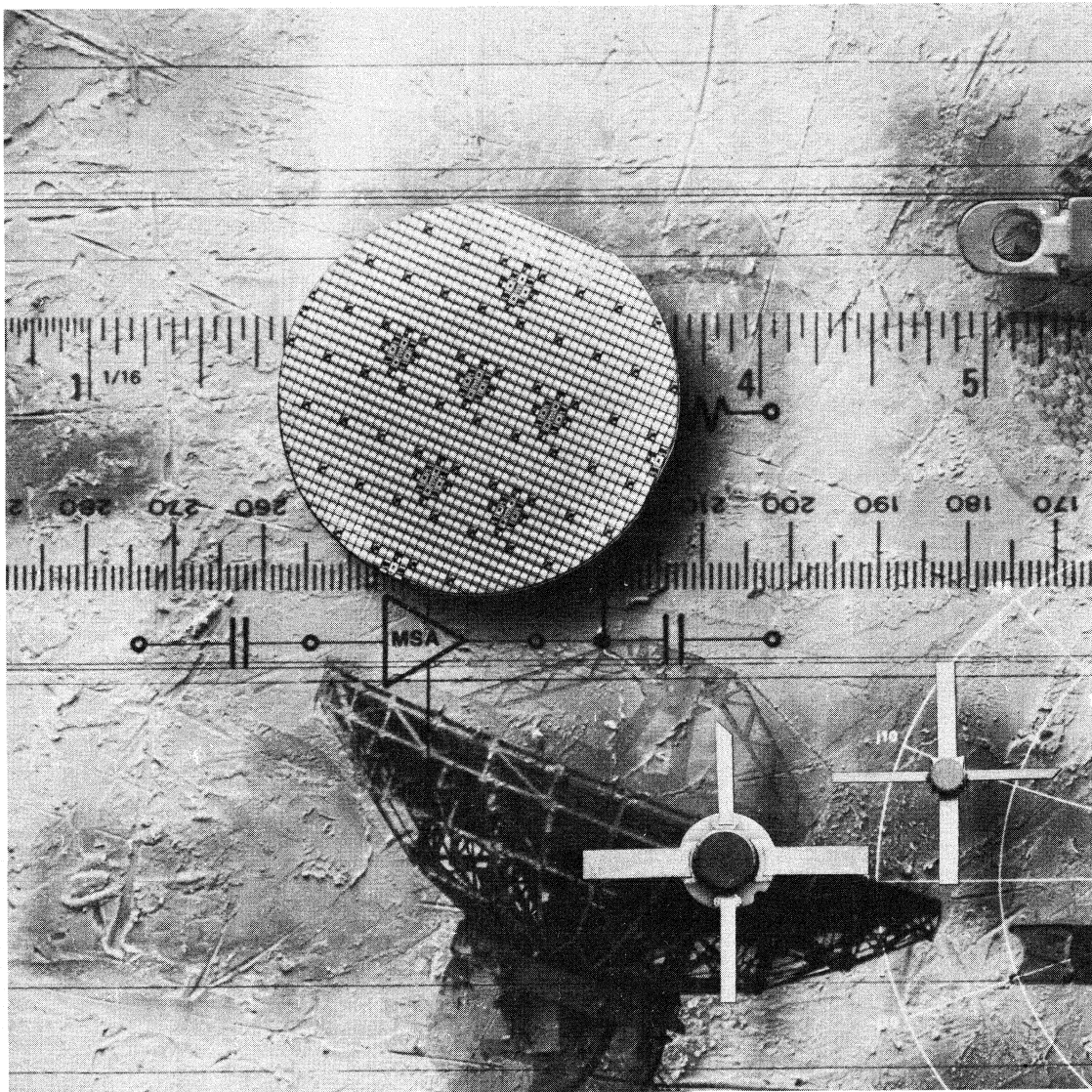

Silicon Monolithic Microwave Integrated Circuits

SELECTION GUIDE	4-2
MagIC™ IAM-SERIES	
ACTIVE MIXERS	4-6
MagIC IFD-SERIES	
PRESCALERS	4-10
MagIC INA-SERIES	
LOW NOISE AMPLIFIERS	4-14
MagIC IVA-SERIES	
VARIABLE GAIN CONTROL AMPLIFIERS	4-20
MODAMP™ MSA-SERIES	
AMPLIFIERS	4-22
MSF-SERIES	
FREQUENCY CONVERTERS	4-132

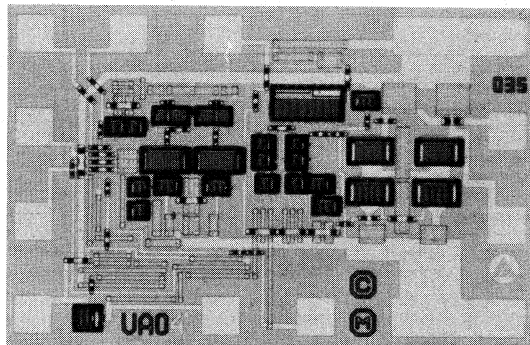
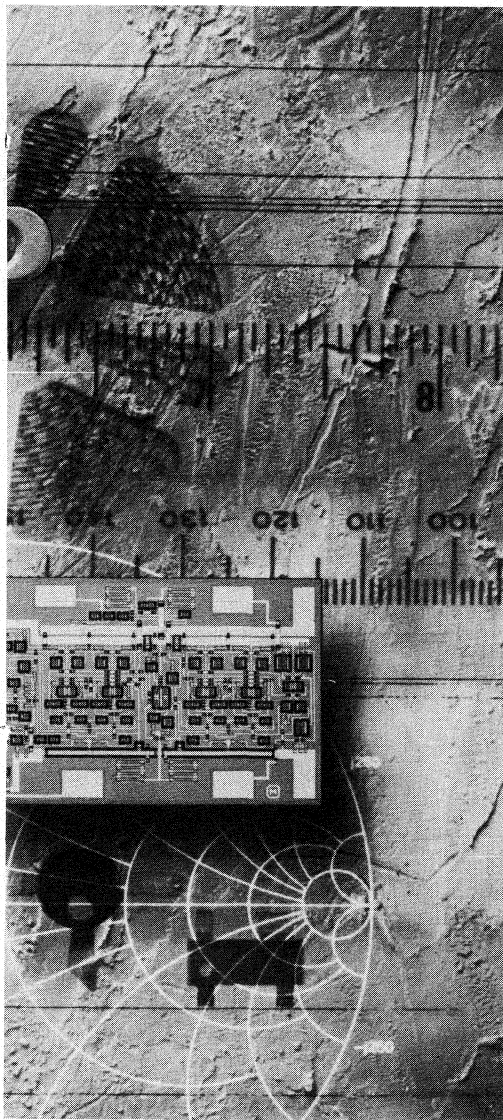

SILICON MMIC AMPLIFIERS
GENERAL PURPOSE AMPLIFIERS

(Typical Specifications @ 25°C Case Temperature)

Part Number	$ S_{21} ^2$ Gain @ 0.1 GHz (dB)	$ S_{21} ^2$ Gain @ 1.0 GHz (dB)	Noise Figure @ 1.0 GHz (dB)	P_{1dB} @ 1.0 GHz (dBm)	Minimum Power Supply Voltage ¹ (V_{CC})	Device Voltage ¹ (V_d)	Device Current ¹ (mA)	Case Type	Page Number
MSA-0100	19.0	17.0	6.0	1.5	7	5.0	17	chip	4-22
MSA-0200	12.5	12.0	6.5	4.5	7	5.0	25	chip	4-34
MSA-0300	12.5	12.0	6.0	10.0	7	5.0	35	chip	4-46
MSA-0170	19.0	16.5	6.0	1.5	7	5.0	17	70 mil stripline	4-28
MSA-0270	12.5	12.0	6.5	4.5	7	5.0	25	70 mil stripline	4-40
MSA-0370	12.5	12.0	6.0	10.0	7	5.0	35	70 mil stripline	4-54
MSA-0135	19.0	16.5	6.0	1.5	7	5.0	17	micro-X	4-26
MSA-0235	12.5	12.0	6.5	4.5	7	5.0	25	micro-X	4-38
MSA-0335	12.5	12.0	6.0	10.0	7	5.0	35	micro-X	4-52
MSA-0104	18.5	15.0	6.0	1.5	7	5.0	17	145 mil plastic	4-24
MSA-0185	18.5	15.0	6.0	1.5	7	5.0	17	85 mil plastic	4-30
MSA-0204	12.5	11.0	6.5	4.5	7	5.0	25	145 mil plastic	4-36
MSA-0285	12.5	12.0	6.5	4.5	7	5.0	25	85 mil plastic	4-42
MSA-0304	12.5	11.0	6.0	10.0	7	5.0	35	145 mil plastic	4-48
MSA-0385	12.5	12.0	6.0	10.0	7	5.0	35	85 mil plastic	4-56
MSA-0186	18.5	15.0	6.0	1.5	7	5.0	17	surface mount plastic	4-32
MSA-0286	12.5	12.0	6.5	4.5	7	5.0	25	surface mount plastic	4-44
MSA-0311	11.5	11.0	6.0	9.0	7	4.7	35	SOT-143 plastic	4-50
MSA-0386	12.5	12.0	6.0	10.0	7	5.0	35	surface mount plastic	4-58

LOW NOISE AMPLIFIERS

(Typical Specifications @ 25°C Case Temperature)

Part Number	$ S_{21} ^2$ Gain @ 0.1 GHz (dB)	$ S_{21} ^2$ Gain @ 1.0 GHz (dB)	Noise Figure @ 1.0 GHz (dB)	P_{1dB} @ 1.0 GHz (dBm)	Minimum Power Supply Voltage ¹ (V_{CC})	Device Voltage ¹ (V_d)	Device Current ¹ (mA)	Case Type	Page Number
MSA-0600	20.5	17.5	3.0	1.5	5	3.5	16	chip	4-82
MSA-0700	13.5	13.0	4.5	5.5	5	4.0	22	chip	4-94
MSA-0800	32.5	24.0	3.0	12.5	10	7.8	36	chip	4-106
INA-01170	32.5	24.0	1.7 ²	10.0	8	5.5	35	70 mil stripline	4-14
INA-02170	31.5	29.0	2.0 ³	10.0	8	5.5	35	70 mil stripline	4-16
INA-03170	26.0	26.0	2.3	2.0	7	4.5	12	70 mil stripline	4-18
MSA-0670	20.5	17.5	3.0	1.5	5	3.5	16	70 mil stripline	4-88
MSA-0770	13.5	13.0	4.5	5.5	5	4.0	22	70 mil stripline	4-100
MSA-0870	32.5	23.5	3.0	12.5	10	7.8	36	70 mil stripline	4-110
MSA-0635	20.0	16.5	3.0	1.5	5	3.5	16	micro-X	4-86
MSA-0735	13.5	13.0	4.5	5.5	5	4.0	22	micro-X	4-98
MSA-0835	32.5	23.0	3.0	12.5	10	7.8	36	micro-X	4-108
MSA-0685	20.0	16.5	3.2	1.5	5	3.5	16	85 mil plastic	4-90
MSA-0785	13.5	12.5	5.0	5.5	5	4.0	22	85 mil plastic	4-102
MSA-0885	32.5	22.5	3.3	12.5	10	7.8	36	85 mil plastic	4-112
MSA-0611	19.5	15.0	3.2	2.0	5	3.3	16	SOT-143 plastic	4-84
MSA-0686	20.0	16.5	3.2	1.0	5	3.5	16	surface mount plastic	4-92
MSA-0711	13.0	12.0	5.0	5.5	5	3.8	22	SOT-143 plastic	4-96
MSA-0786	13.5	12.5	5.0	5.5	5	4.0	22	surface mount plastic	4-104
MSA-0886	32.5	22.5	3.3	12.5	10	7.8	36	surface mount plastic	4-114

Notes: 1. Refer to schematic drawing on individual data sheet.

2. Noise Figure at 0.1 GHz

3. Noise Figure at 0.5 GHz

SILICON MMIC AMPLIFIERS (CONTINUED)

MEDIUM POWER AMPLIFIERS

(Typical Specifications at 25°C Case Temperature)

Part Number	S ₂₁ ² Gain @ 0.1 GHz (dB)	S ₂₁ ² Gain @ 1.0 GHz (dB)	Noise Figure @ 1.0 GHz (dB)	P _{1dB} @ 1.0 GHz (dBm)	Minimum Power Supply Voltage ¹ (V _{cc})	Device Voltage ¹ (V _d)	Device Current ¹ (mA)	Case Type	Page Number
MSA-0400	8.5	8.5	6.5	16.0	10	6.3	90	chip	4-60
MSA-0420	8.5	8.5	6.5	16.0	10	6.3	90	200 mil BeO disk	4-66
MSA-0470	8.5	8.3	6.5	12.5	7	5.3	50	70 mil stripline	4-70
MSA-0520	9.0	8.5	6.5	23.0	15	12.0	165	200 mil BeO disk	4-80
MSA-1023	8.5	8.5	7.0	27.0	20	15.0	325	230 mil BeO flange	4-120
MSA-0435	8.5	8.3	6.5	12.5	7	5.3	50	micro-X	4-68
MSA-0404	8.3	7.7	7.0	11.5	7	5.3	50	145 mil plastic	4-64
MSA-0485	8.3	8.0	7.0	12.5	7	5.3	50	85 mil plastic	4-72
MSA-0504	8.0	7.0	6.5	18.0	12	8.4	80	145 mil plastic	4-76
MSA-0486	8.3	8.0	7.0	12.5	7	5.3	50	surface mount plastic	4-74
MSA-0505	8.0	7.0	6.5	18.0	12	8.4	80	surface mount plastic	4-78

WIDE DYNAMIC RANGE AMPLIFIERS

(Typical Specifications at 25°C Case Temperature)

Part Number	S ₂₁ ² Gain @ 0.1 GHz (dB)	S ₂₁ ² Gain @ 1.0 GHz (dB)	Noise Figure @ 1.0 GHz (dB)	P _{1dB} @ 1.0 GHz (dBm)	Minimum Power Supply Voltage ¹ (V _{cc})	Device Voltage ¹ (V _d)	Device Current ¹ (mA)	Case Type	Page Number
MSA-1110	12.5	11.0	4.0	17.5	8	5.5	60	100 mil stripline	4-126
MSA-1120	12.5	11.0	4.0	17.5	8	5.5	60	200 mil BeO disk	4-128
MSA-1104	12.5	10.5	4.2	17.5	8	5.5	60	145 mil plastic	4-122
MSA-1105	12.5	10.5	4.2	17.5	8	5.5	60	surface mount plastic	4-124

HIGH FREQUENCY AMPLIFIERS

(Typical Specifications at 25°C Case Temperature)

Part Number	S ₂₁ ² Gain @ 0.1 GHz (dB)	S ₂₁ ² Gain @ 1.0 GHz (dB)	Noise Figure @ 1.0 GHz (dB)	P _{1dB} @ 1.0 GHz (dBm)	Minimum Power Supply Voltage ¹ (V _{cc})	Device Voltage ¹ (V _d)	Device Current ¹ (mA)	Case Type	Page Number
MSA-0910	8.0	8.0	6.0	11.5	12	7.8	35	100 mil stripline	4-116
MSA-0986	8.0	7.5	6.0	11.0	12	7.8	35	surface mount plastic	4-118

SPECIAL PURPOSE/MINIMAL OR NO FEEDBACK AMPLIFIERS

(Typical Specifications at 25°C Case Temperature)

Part Number	S ₂₁ ² Gain @ 0.1 GHz (dB)	S ₂₁ ² Gain @ 1.0 GHz (dB)	Noise Figure @ 1.0 GHz (dB)	P _{1dB} @ 1.0 GHz (dBm)	Minimum Power Supply Voltage ¹ (V _{cc})	Device Voltage ¹ (V _d)	Device Current ¹ (mA)	Case Type	Page Number
MSA-0800	32.5	24.0	3.0	12.5	10	7.8	36	chip	4-106
MSA-0870	32.5	23.5	3.0	12.5	10	7.8	36	70 mil stripline	4-110
MSA-9970	17.5	16.0	—	14.5	10	7.8	35	70 mil stripline	4-130
MSA-0835	32.5	23.0	3.0	12.5	10	7.8	36	micro-X	4-108
MSA-0885	32.5	22.5	3.3	12.5	10	7.8	36	85 mil plastic	4-112
MSA-0886	32.5	22.5	3.3	12.5	10	7.8	36	surface mount plastic	4-114

VARIABLE GAIN CONTROL AMPLIFIERS

(Typical Specifications @ 25°C Case Temperature)

Part Number	S ₂₁ ² Gain @ 0.5 GHz (dB)	Gain Control Range @ 0.5 GHz (dB)	3 dB Bandwidth (GHz)	Power Supply Voltage (V _{cc} -V _{ee})	Supply Current (mA)	Case Type	Page Number
IVA-05118	26	30	1.5	5	35	180 mil surface mount	4-20

Notes: 1. Refer to schematic drawing on individual data sheets.

Silicon MMIC Selection Guide

SILICON MMIC AMPLIFIERS (CONTINUED)

TYPICAL PERFORMANCE: SILICON MMIC AMPLIFIERS @ $T_A = 25^\circ\text{C}$

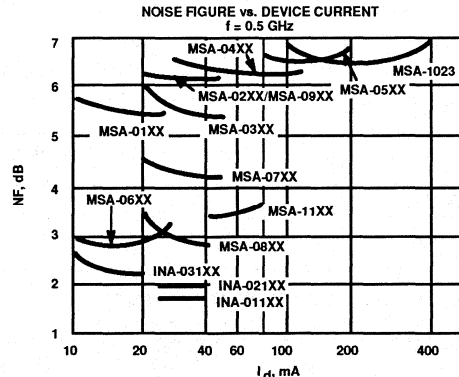
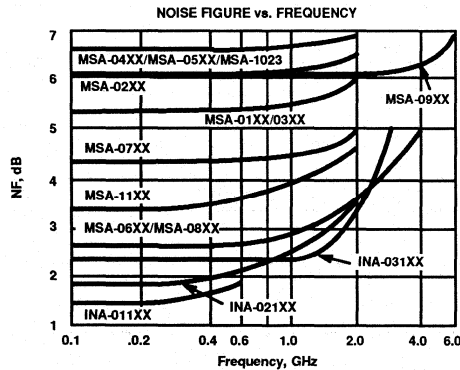
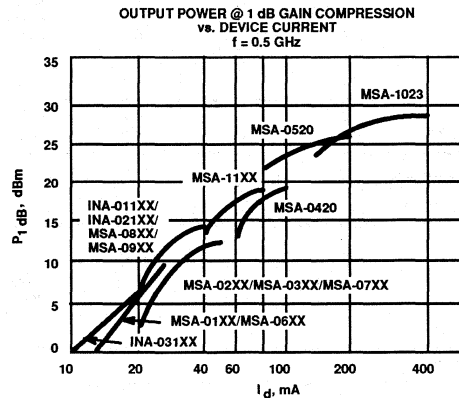
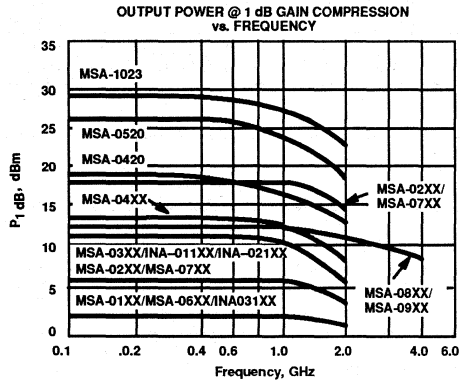
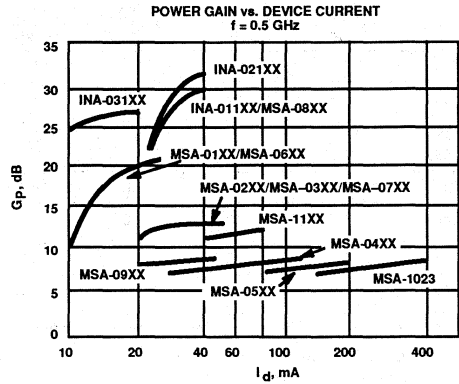
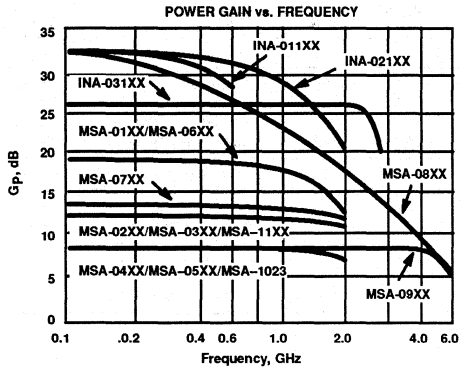

SILICON MMIC MIXERS

3 PORT DOUBLE BALANCED ACTIVE MIXERS

(Typical Specifications @ 25°C Case Temperature)

Part Number	RF & LO Frequency (GHz)	IF Frequency (GHz)	RF-IF Conversion Gain (dB)	Third Order Intercept Point (dBm)	LO-RF Isolation (dB)	Minimum Power Supply Voltage (V)	Device Current (mA)	Case Type	Page Number
IAM-81018	0.05-5.0	DC to 1.0	8.5 ¹	31	30 ¹	5	12.5	180 mil surface mount	4-6
IAM-82018	0.05-5.0	DC to 2.0	15.0 ²	182	30 ²	10	50	180 mil surface mount	4-8

2 PORT SELF OSCILLATING MIXERS

(Typical Specifications @ 25°C Case Temperature)

Part Number	RF & LO Frequency (GHz)	IF Frequency (GHz)	RF-IF Conversion Gain (dB)	Third Order Intercept Point (dBm)	LO-RF Isolation (dB)	Minimum Power Supply Voltage (V)	Device Current (mA)	Case Type	Page Number
MSF-8635	0.1-2.0	DC to 0.5	9.0 ³	7 ³	0 ³	5	16	micro-X	4-132
MSF-8670	0.1-2.0	DC to 0.5	9.0 ³	7 ³	0 ³	5	16	70 mil stripline	4-132
MSF-8685	0.1-2.0	DC to 0.5	8.0 ³	7 ³	0 ³	5	16	85 mil plastic	4-132
MSF-8835	0.5-8.0	DC to 2.0	9.0 ⁴	16 ⁴	0 ⁴	10	36	micro-X	4-136
MSF-8870	0.5-8.0	DC to 2.0	9.0 ⁴	16 ⁴	0 ⁴	10	36	70 mil stripline	4-136
MSF-8885	0.5-8.0	DC to 2.0	8.5 ⁴	16 ⁴	0 ⁴	10	36	85 mil plastic	4-136

- Notes: 1. -20 dBm RF input, -5 dBm LO input, RF at 2.0 GHz, LO at 1.75 GHz
 2. -20 dBm RF input, 0 dBm LO input, RF at 2.0 GHz, LO at 1.75 GHz
 3. -20 dBm RF input, RF at 1.575 GHz, LO at 1.4 GHz
 4. -20 dBm RF input, RF at 4.2 GHz, LO at 5.15 GHz

SILICON MMIC STATIC PRESCALERS

(Typical Specifications @ 25°C Case Temperature)

Part Number	f _{IN} MIN (GHz)	f _{IN} MAX (GHz)	Dividing Factor	Input Sensitivity @ f = 1.0 GHz (dBm)	Output Level (dBm)	Minimum Power Supply Voltage (V _{CC-V_{EE}})	Device Current (mA)	Case Type	Page Number
IFD-50010	0.05	5.0	+4	-30	-13 ⁵	5	25	100 mil stripline	4-10
IFD-50210	0.05	3.5	+4	-30	-13 ⁶	5	25	100 mil stripline	4-12

- Notes: 5. f = 0.05 to 5.0 GHz
 6. f = 0.05 to 3.5 GHz

Features

- 8 dB RF-IF Conversion Gain From 0.05 - 5 GHz
- IF Output From DC to 1 GHz
- Low Power Dissipation: 60 mW at $V_{CC} = 5$ V typ.
- Single Polarity Bias Supply: $V_{CC} = 4$ to 8 V
- Load-insensitive Performance
- Conversion Gain Flat Over Temperature
- Low LO Power Requirements: -5 dBm typical
- Low RF to IF Feedthrough, Low LO Leakage
- Hermetic Glass-Metal Surface Mount Package

Description

Avantek's IAM-81018 is a complete low-power-consumption double-balanced active mixer housed in a miniature glass-metal hermetic surface mount package. It is designed for narrow or wide bandwidth commercial, industrial and military applications having RF inputs up to 5 GHz and IF outputs from DC to 1 GHz. Operation at RF and LO frequencies less than 50 MHz can be achieved using optional external capacitors to ground. The IAM-81018 is particularly well suited for applications that require load-insensitive conversion gain and good spurious signal suppression with minimum LO and bias power consumption. Typical applications include frequency down conversion, modulation, demodulation and phase detection for fiber-optic, GPS satellite navigation, mobile radio, and battery powered communications receivers.

The IAM series of Gilbert multiplier-based frequency converters is fabricated using Avantek's 10 GHz f_T , 25 GHz f_{MAX} ISOSAT™-I silicon bipolar process. This process uses nitride self-alignment, submicrometer lithography, trench isolation, ion implantation, gold metallization and polyimide inter-metal dielectric and scratch protection to achieve excellent performance, uniformity and reliability.

Avantek 180 mil Package

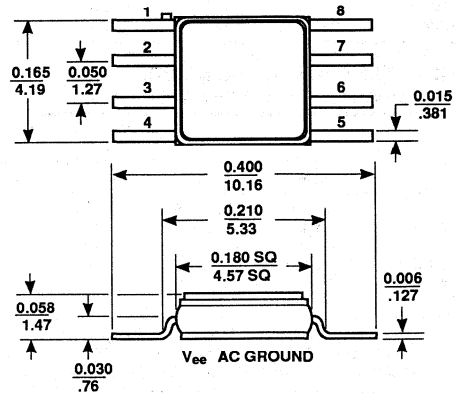

PIN DESCRIPTION	
1 IF Output	8 RF Ground (optional)
2 V_{EE} , AC Ground	7 V_{CC}
3 V_{EE} , AC Ground	6 LO Ground (optional)
4 RF Input	5 LO Input
Bottom of Package is V_{EE} (AC Ground)	

Notes:
 (unless otherwise speci
 1. Dimensions are in mm
 2. Tolerances in .xxx = ±.005 mm .xx = ±.13

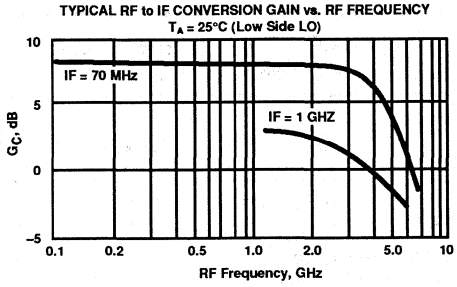

Electrical Specifications¹, $T_A = 25^\circ\text{C}$

Symbol	Parameters and Test Conditions: $V_{CC} = 5$ V, $Z_0 = 50 \Omega$, LO = -5 dBm, RF = -20 dBm	Units	Min.	Typ.	Max.	
G_C	Conversion Gain	RF = 2 GHz, LO = 1.75 GHz	dB	7.0	8.5	10
f_3 dB _{RF}	RF Bandwidth (G_C 3 dB Down)	IF = 250 MHz	GHz		4.5	
f_3 dB _{IF}	IF Bandwidth (G_C 3 dB Down)	LO = 2 GHz	GHz		0.6	
P_1 dB	IF Output Power at 1 dB Gain Compression	RF = 2 GHz, LO = 1.75 GHz	dBm		-6	
IP_3	IF Output Third Order Intercept Point	RF = 2 GHz, LO = 1.75 GHz	dBm		3	
NF	SSB Noise Figure	RF = 2 GHz, LO = 1.75 GHz	dB		15	
VSWR	RF Port VSWR	$f = 0.05$ to 5 GHz			1.5:1	
	LO Port VSWR	$f = 0.05$ to 5 GHz			1.5:1	
	IF Port VSWR	$f < 1$ GHz			1.5:1	
RF _{if}	RF Feedthrough at IF Port	RF = 2 GHz, LO = 1.75 GHz	dBc		-25	
LO _{if}	LO Leakage at IF Port	LO = 1.75 GHz	dBm		-25	
LO _{rf}	LO Leakage at RF Port	LO = 1.75 GHz	dBm		-35	
I_{CC}	Supply Current		mA	10	12.5	16

Note: 1. The recommended operating voltage range for this device is 4 to 8 V. Typical performance as a function of voltage is on the following page.

IAM-81018 Silicon Bipolar MMIC 5 GHz Active Double Balanced Mixer/IF Amp

Absolute Maximum Ratings

Parameter	Absolute Maximum ¹
Device Voltage	10 V
Power Dissipation ^{2,3}	300 mW
RF Input Power	+14 dBm
LO Input Power	+14 dBm
Junction Temperature	200°C
Storage Temperature	-65°C to 200°C
Thermal Resistance ^{2,4} : $\theta_{JC} = 50^\circ\text{C/W}$	

Notes:

1. Permanent damage may occur if any of these limits are exceeded.
2. T_{CASE} = 25°C
3. Derate at 20 mW/°C for T_C > 185°C
4. See MEASUREMENTS section "Thermal Resistance" for more information.

Typical Biasing Configuration and Functional Block Diagram

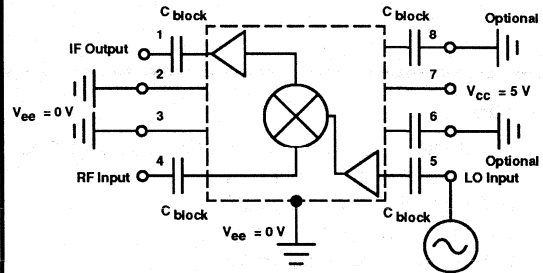

Note: No external BALUNs are required.

Typical Performance, T_A = 25°C, V_{CC} = 5 V RF: -20 dBm at 2 GHz, LO: -5 dBm at 1.75 GHz (unless otherwise noted)

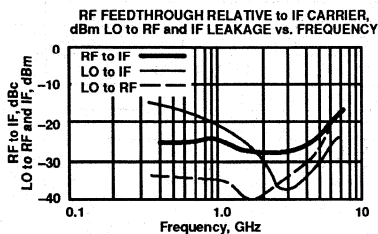
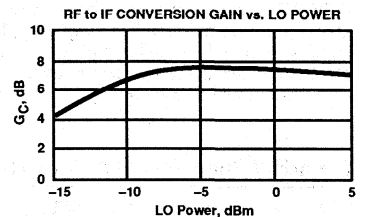
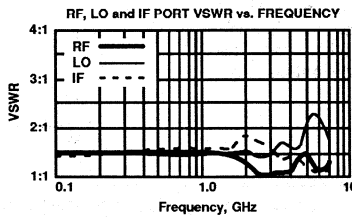
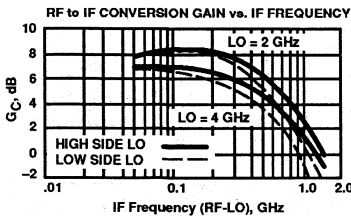
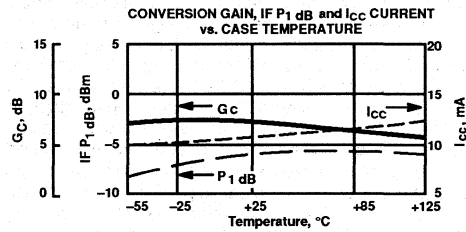
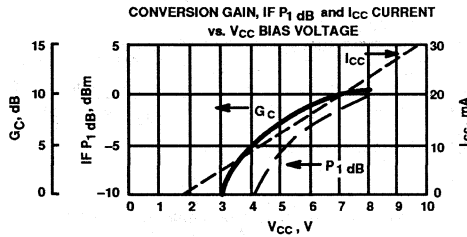

HARMONIC INTERMODULATION SUPPRESSION (dB BELOW DESIRED OUTPUT)
RF at 1 GHz, LO at 0.752 GHz, IF at 0.248 GHz

Harmonic LO Order	0	1	2	3	4	5
0	-	21	35	>75	>75	>75
1	12	0	48	48	>75	>75
2	13	41	39	71	>75	>75
3	36	28	53	57	>75	>75
4	27	49	49	72	>75	>75
5	45	35	63	62	>75	>75

Harmonic RF Order
X_{mn} = P_{if}-P_{rf}(m**r*-n**l*o)

Features

- 15 dB RF-IF Conversion Gain From 0.05 - 5 GHz
- IF Output From DC to 2 GHz
- IF Output P_{1dB} up to + 12 dBm
- Single Polarity Bias Supply: $V_{CC} = 7$ to 13 V
- Load-insensitive Performance
- Conversion Gain Flat Over Temperature
- Low LO Power Requirements: 0 dBm typical
- Low RF to IF Feedthrough, Low LO Leakage
- Hermetic Glass-Metal Surface Mount Package

Description

Avantek's IAM-82018 is a complete moderate-power double-balanced active mixer housed in a miniature glass-metal hermetic surface mount package. It is designed for narrow or wide bandwidth commercial, industrial and military applications having RF inputs up to 5 GHz and IF outputs from DC to 2 GHz. Operation at RF and LO frequencies less than 50 MHz can be achieved using optional external capacitors to ground. The IAM-82018 is particularly well suited for applications that require load-insensitive conversion gain and good spurious signal suppression and moderate dynamic range with minimum LO power. Typical applications include frequency downconversion, modulation, demodulation and phase detection for fiber-optic, GPS satellite navigation, mobile radio, and communications receivers.

The IAM series of Gilbert multiplier-based frequency converters is fabricated using Avantek's 10 GHz f_T , 25 GHz f_{MAX} ISOSAT™-I silicon bipolar process which uses nitride self-alignment, submicrometer lithography, trench isolation, ion implantation, gold metallization and polyimide inter-metal dielectric and scratch protection to achieve excellent performance, uniformity and reliability.

Electrical Specifications¹, $T_A = 25^\circ\text{C}$

Symbol	Parameters and Test Conditions: $V_{CC} = 10$ V, $Z_0 = 50$ Ω , $LO = 0$ dBm, $RF = -20$ dBm	Units	Min.	Typ.	Max.	
G_C	Conversion Gain	RF = 2 GHz, LO = 1.75 GHz	dB	13.5	15	16.5
f_3 dB _{RF}	RF Bandwidth (G_C 3 dB Down)	IF = 250 MHz	GHz		5.5	
f_3 dB _{IF}	IF Bandwidth (G_C 3 dB Down)	LO = 2 GHz	GHz		0.6	
P_{1dB}	IF Output Power @ 1 dB Gain Compression	RF = 2 GHz, LO = 1.75 GHz	dBm		8	
IP ₃	IF Output Third Order Intercept Point	RF = 2 GHz, LO = 1.75 GHz	dBm		18	
NF	SSB Noise Figure	RF = 2 GHz, LO = 1.75 GHz	dB		16	
VSWR	RF Port VSWR	$f = 0.05$ to 5 GHz			1.5:1	
	LO Port VSWR	$f = 0.05$ to 5 GHz			2:1	
	IF Port VSWR	$f < 2$ GHz			2.3:1	
RF _{if}	RF Feedthrough at IF Port	RF = 2 GHz, LO = 1.75 GHz	dBc		-30	
LO _{if}	LO Leakage at IF Port	LO = 1.75 GHz	dBm		-20	
LO _{rf}	LO Leakage at RF Port	LO = 1.75 GHz	dBm		-30	
I_{CC}	Supply Current		mA	40	50	60

Note: 1. The recommended operating voltage range for this device is 7 to 13 V. Typical performance as a function of voltage is on the following page.

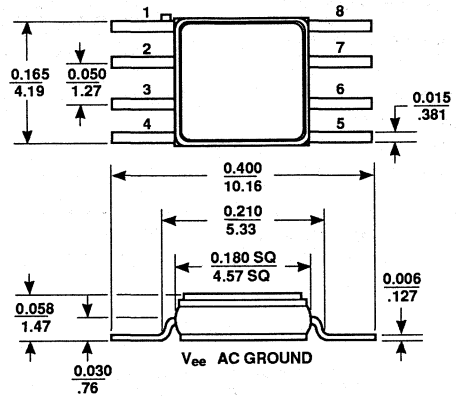
Avantek 180 mil Package

PIN DESCRIPTION	
1 IF Output	8 RF Ground (optional)
2 V_{ee} , AC Ground	7 V_{cc}
3 V_{ee} , AC Ground	6 LO Ground (optional)
4 RF Input	5 LO Input
Bottom of Package is V_{ee} (AC Ground)	

Notes:
 (unless otherwise specified)
 1. Dimensions are in mm
 2. Tolerances are in .xxx = ± 0.005 mm .xx = ± 0.13

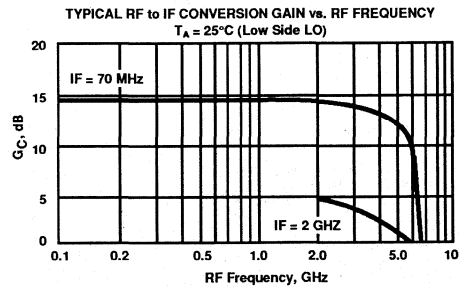

IAM-82018 Silicon Bipolar MMIC 5 GHz Active Double Balanced Mixer/IF Amp

Absolute Maximum Ratings

Parameter	Absolute Maximum ¹
Device Voltage	15 V
Power Dissipation ^{2,3}	1200 mW
RF Input Power	+14 dBm
LO Input Power	+14 dBm
Junction Temperature	200°C
Storage Temperature	-65°C to 200°C
Thermal Resistance ^{2,4} : $\theta_{JC} = 45^\circ\text{C/W}$	

Notes:

1. Permanent damage may occur if any of these limits are exceeded.
2. TCASE = 25°C
3. Derate at 22.2 mW/°C for TC > 146°C
4. See MEASUREMENTS section "Thermal Resistance" for more information.

Typical Biasing Configuration and Functional Block Diagram

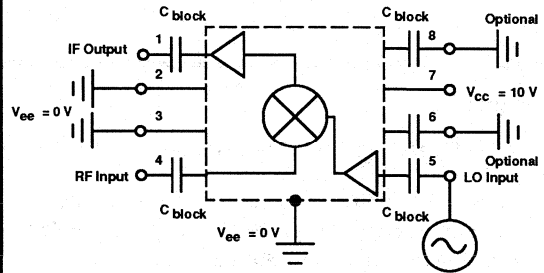

Note: No external BALUNs are required.

Typical Performance, TA = 25°C, VCC = 10 V
RF: -20 dBm at 2 GHz, LO: 0 dBm at 1.75 GHz
 (unless otherwise noted)

CONVERSION GAIN, IF P1 dB and ICC CURRENT vs. VCC BIAS VOLTAGE

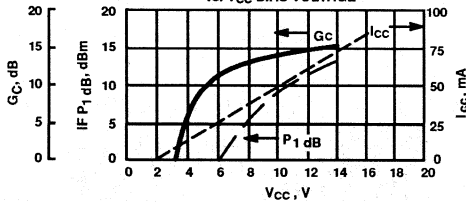

CONVERSION GAIN, IF P1 dB and ICC CURRENT vs. CASE TEMPERATURE

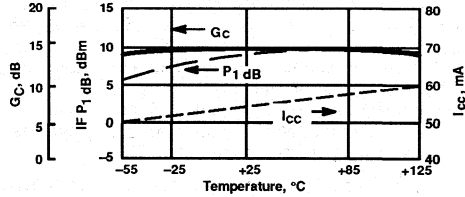

RF to IF CONVERSION GAIN vs. IF FREQUENCY

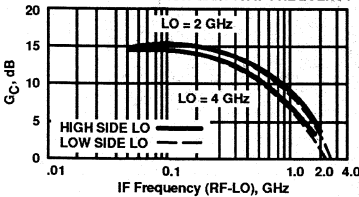

RF, LO and IF PORT VSWR vs. FREQUENCY

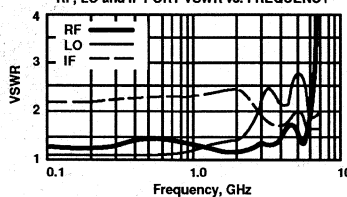

RF to IF CONVERSION GAIN vs. LO POWER

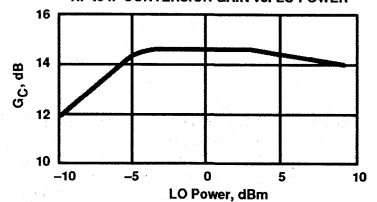

RF FEEDTHROUGH RELATIVE to IF CARRIER, 0 dBm LO to RF and IF LEAKAGE vs. FREQUENCY

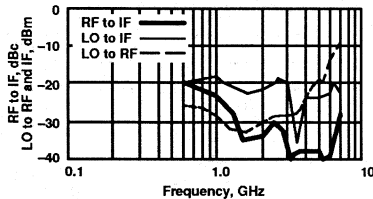

HARMONIC INTERMODULATION SUPPRESSION (dB BELOW DESIRED OUTPUT)

Harmonic LO Order	RF at 1 GHz, LO at 0.752 GHz, IF at 0.248 GHz				
	0	1	2	3	4
0	-	23	40	>75	>75
1	12	0	52	60	>75
2	6	35	43	>75	>75
3	27	18	59	74	>75
4	22	38	52	>75	>75
5	41	36	73	74	>75

X_{mn} = P_i-P_j(mⁿ-n^m)_o

Features

- **Wide Operating Frequency Range:**
0.05 to 5 GHz typical
- **Low Phase Noise:** -140 dBc/Hz, 1 KHz offset
- **High Input Sensitivity:** -30 dBm at 1 GHz typical
- **Low Output Level:** -13 dBm typical
- **Single Supply Voltage:** $V_{cc} = 5\text{ V}$
- **Low Power Dissipation:** 125 mW typical
- **Hermetic Gold-Ceramic Surface Mount Package**

Description

Avantek's IFD-50010 is a low-phase-noise silicon bipolar static digital frequency divider using two scaled Emitter-Coupled-Logic (ECL) master-slave D flip-flops and sensitive buffer amplifiers. It is housed in a hermetic, high reliability ceramic package suitable for commercial, industrial and military applications. Typical applications include stabilized or digitally controlled local oscillators for GPS, TVRO, DBS, cellular radio and military communications receivers, and frequency synthesizers and counters in instrumentation systems.

The IFD series of digital frequency dividers is fabricated using Avantek's 15 GHz f_r , 20 GHz f_{MAX} ISOSAT™-I silicon bipolar process which uses nitride self-alignment, submicrometer lithography, trench isolation, ion implantation, gold metallization and polyimide inter-metal dielectric and scratch protection to achieve excellent performance, uniformity and reliability.

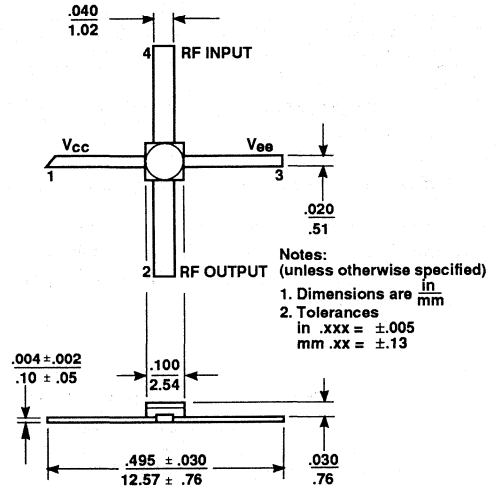
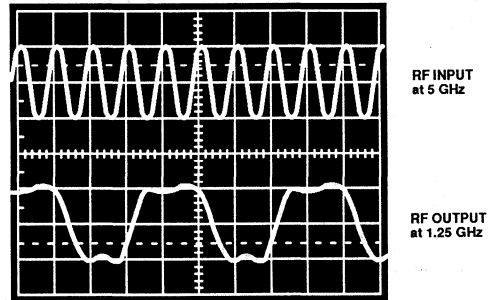
Avantek 100 mil Package

Typical Output Response With 5 GHz Input

Electrical Specifications¹, $T_A = 25^\circ\text{C}$

Symbol	Parameters and Test Conditions: $V_{cc} - V_{ee} = 5\text{ V}$, $Z_0 = 50\ \Omega$		Units	Min.	Typ.	Max.
F _{MAX}	Maximum Clock Frequency	$P_{in} = -10\text{ dBm}$ (200 mVpp)	GHz	4.5	5.0	
F _{MIN}	Minimum Clock Frequency	$P_{in} = -10\text{ dBm}$ (200 mVpp)	GHz		0.05	
IS	Input Sensitivity	$f = 1\text{ GHz}$	dBm		-30	
			mVpp		20	
OL	Output Level	$f = 0.05\text{ to }5\text{ GHz}$	dBm		-13	
			mVpp		140	
SL _{MAX}	Highest Nonharmonic Spurious Level	$f = 0.05\text{ to }5\text{ GHz}$	dBm		-35	
VSWR	Input VSWR	$f = 0.05\text{ to }5\text{ GHz}$			1.5:1	
	Output VSWR	$f = 0.05\text{ to }5\text{ GHz}$			2.0:1	
PN	SSB Phase Noise	$f = 2\text{ GHz}$, 1 kHz offset	dBc/Hz		-140	
		$f = 4\text{ GHz}$, 1 kHz offset			-135	
T _r	Output Rise Time	$f = 5\text{ GHz}$	psec		100	
T _f	Output Fall Time	$f = 5\text{ GHz}$	psec		100	
I _{cc}	Supply Current		mA	20	30	40

Note: 1. The recommended operating voltage range for this device is 4.5 to 5.5 V.

IFD-50010 Silicon Bipolar MMIC 5 GHz Divide-by-4 Static Prescaler

Absolute Maximum Ratings

Parameter	Absolute Maximum ¹
Device Voltage	6 V
Power Dissipation ^{2,3}	250 mW
RF Input Power	+10 dBm
Junction Temperature	200°C
Storage Temperature	-65°C to 200°C

Thermal Resistance^{2,4}: $\theta_{JC} = 95^\circ\text{C/W}$

Notes:

- Permanent damage may occur if any of these limits are exceeded.
- $T_{CASE} = 25^\circ\text{C}$
- Derate at 10.5 mW/°C for $T_C > 176^\circ\text{C}$
- See MEASUREMENTS section "Thermal Resistance" for more information.

Typical Biasing Configuration

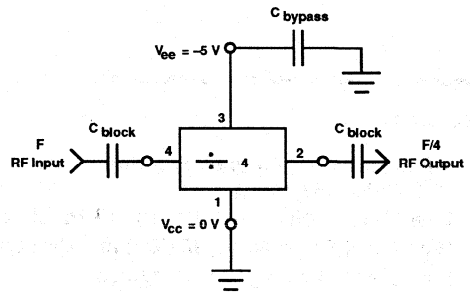

Typical Performance, $T_A = 25^\circ\text{C}$

$P_{in} = -10\text{ dBm}$

(unless otherwise noted)

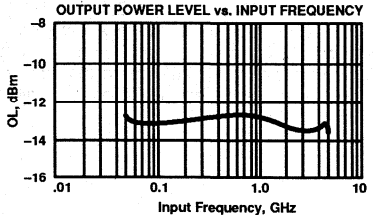
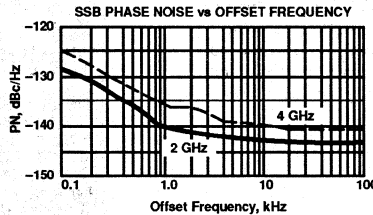
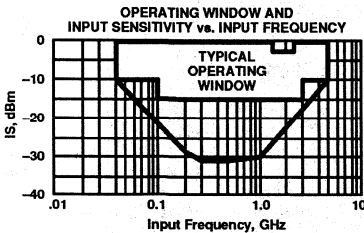
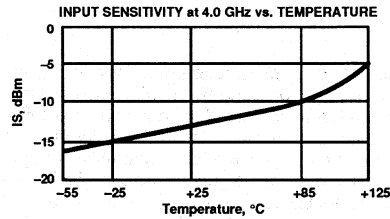
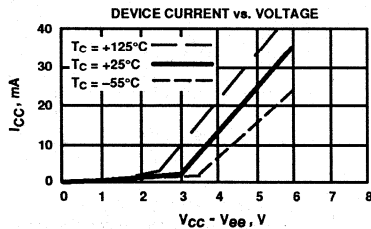

Chip Block Diagram

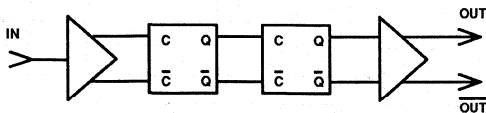

Typical Stabilized LO Configuration

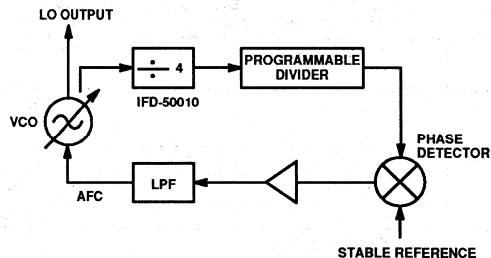

Features

- **Wide Operating Frequency Range:**
0.05 to 3.5 GHz typical
- **Low Phase Noise:** -140 dBc/Hz, 1 KHz offset
- **High Input Sensitivity:** -30 dBm at 1 GHz typical
- **Low Output Level:** -13 dBm typical
- **Single Supply Voltage:** $V_{CC} = 5\text{ V}$
- **Low Power Dissipation:** 125 mW typical
- **Hermetic Gold-Ceramic Surface Mount Package**

Description

Avantek's IFD-50210 is a low-phase-noise silicon bipolar static digital frequency divider using two scaled Emitter-Coupled-Logic (ECL) master-slave D flip-flops and sensitive buffer amplifiers. It is housed in a hermetic, high reliability ceramic package suitable for commercial, industrial and military applications. Typical applications include stabilized or digitally controlled local oscillators for GPS, TVRO, DBS, cellular radio and military communications receivers, and frequency synthesizers and counters in instrumentation systems.

The IFD series of digital frequency dividers is fabricated using Avantek's 15 GHz f_T , 20 GHz f_{MAX} ISOSAT™-1 silicon bipolar process which uses nitride self-alignment, submicrometer lithography, trench isolation, ion implantation, gold metallization and polyimide inter-metal dielectric and scratch protection to achieve excellent performance, uniformity and reliability.

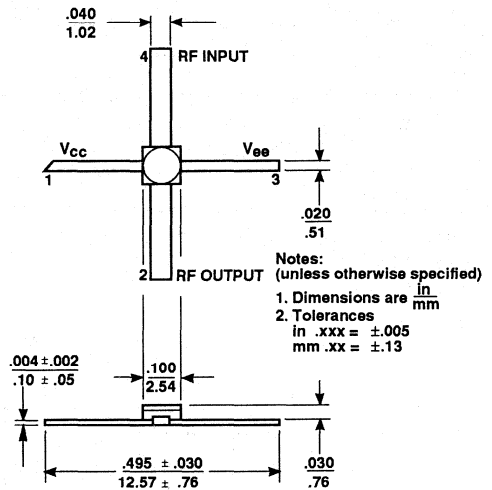
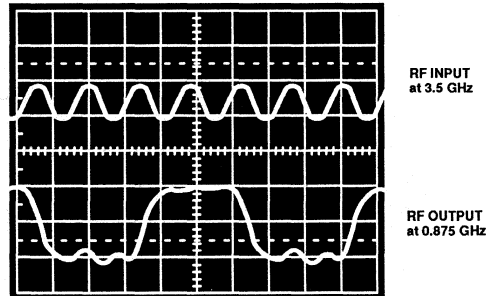
Avantek 100 mil Package

Typical Output Response With 3.5 GHz Input

Electrical Specifications¹, $T_A = 25^\circ\text{C}$

Symbol	Parameters and Test Conditions: $V_{CC} - V_{EE} = 5\text{ V}$, $Z_O = 50\ \Omega$	Units	Min.	Typ.	Max.
FMAX	Maximum Clock Frequency $P_{in} = -10\text{ dBm}$ (200 mVpp)	GHz	3.0	3.5	
FMIN	Minimum Clock Frequency $P_{in} = -10\text{ dBm}$ (200 mVpp)	GHz		0.05	
IS	Input Sensitivity $f = 1\text{ GHz}$	dBm		-30	
		mVpp		20	
OL	Output Level $f = 0.05\text{ to }3.5\text{ GHz}$	dBm		-13	
		mVpp		140	
SLMAX	Highest Nonharmonic Spurious Level $f = 0.05\text{ to }3.5\text{ GHz}$	dBm		-35	
VSWR	Input VSWR $f = 0.05\text{ to }3.5\text{ GHz}$			1.5:1	
	Output VSWR $f = 0.05\text{ to }3.5\text{ GHz}$			2.0:1	
PN	SSB Phase Noise $f = 2\text{ GHz}, 1\text{ kHz offset}$ $f = 3.5\text{ GHz}, 1\text{ kHz offset}$	dBc/Hz		-140	
				-135	
T_r	Output Rise Time $f = 3.5\text{ GHz}$	psec		100	
T_f	Output Fall Time $f = 3.5\text{ GHz}$	psec		100	
I_{CC}	Supply Current	mA	20	30	40

Note: 1. The recommended operating voltage range for this device is 4.5 to 5.5 V.

IFD-50210 Silicon Bipolar MMIC 3.5 GHz Divide-by-4 Static Prescaler

Absolute Maximum Ratings

Parameter	Absolute Maximum ¹
Device Voltage	6 V
Power Dissipation ^{2,3}	250 mW
RF Input Power	+10 dBm
Junction Temperature	200°C
Storage Temperature	-65°C to 200°C
Thermal Resistance ^{2,4} : $\theta_{jC} = 95^\circ\text{C/W}$	

Notes:

- Permanent damage may occur if any of these limits are exceeded.
- $T_{CASE} = 25^\circ\text{C}$
- Derate at $10.5 \text{ mW}/^\circ\text{C}$ for $T_C > 176^\circ\text{C}$
- See MEASUREMENTS section "Thermal Resistance" for more information.

Typical Biasing Configuration

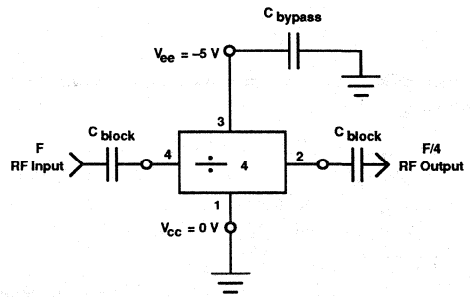

Typical Performance, $T_A = 25^\circ\text{C}$

$P_{in} = -10 \text{ dBm}$

(unless otherwise noted)

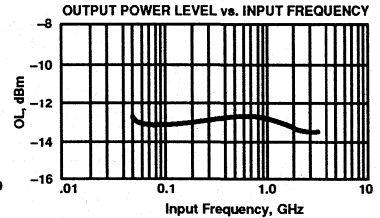
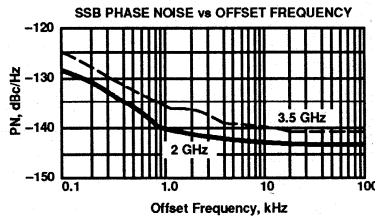
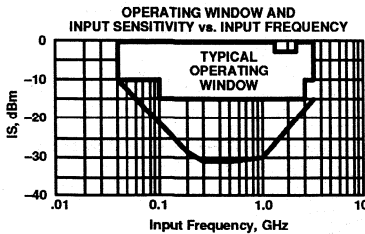
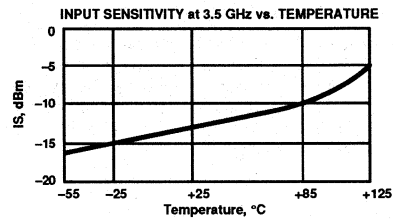
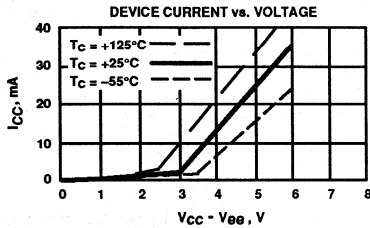

Chip Block Diagram

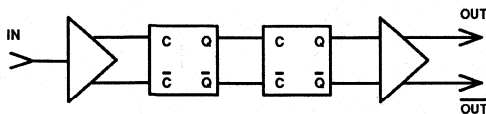

Typical Stabilized LO Configuration

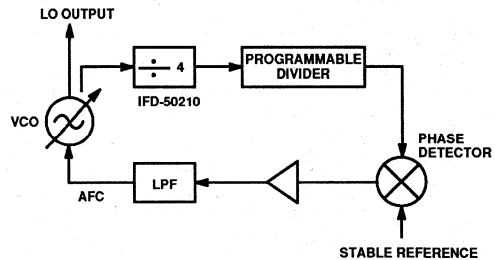

Features

- Cascadable 50 Ω Gain Block
- Low Noise Figure: 1.7 dB typical at 100 MHz
- High Gain: 32.5 dB typical at 100 MHz
- 3 dB Bandwidth: DC to 500 MHz
- Unconditionally Stable ($k > 1$)
- Hermetic Gold-Ceramic Surface Mount Package

Description

Avantek's INA-01170 is a low-noise silicon bipolar Monolithic Microwave Integrated Circuit (MMIC) feedback amplifier housed in a hermetic, high reliability package. It is designed for narrow or wide bandwidth industrial and military applications that require high gain and low noise IF or RF amplification.

The INA series of MMICs is fabricated using Avantek's 10 GHz f_T , 25 GHz f_{MAX} ISOSAT™-I silicon bipolar process which uses nitride self-alignment, submicrometer lithography, trench isolation, ion implantation, gold metallization and polyimide inter-metal dielectric and scratch protection to achieve excellent performance, uniformity and reliability.

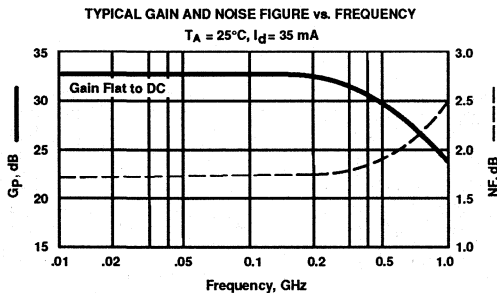
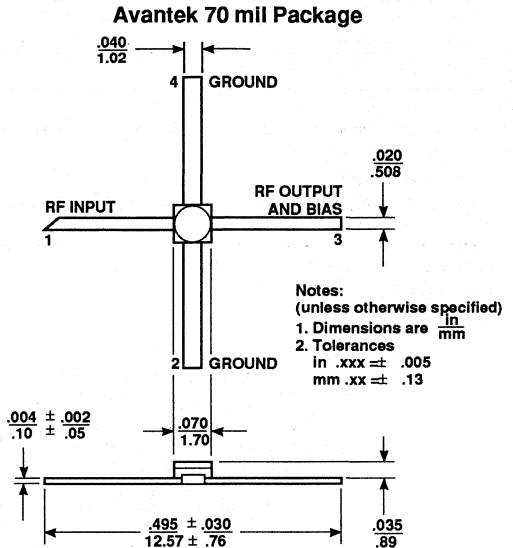

Typical Biasing Configuration

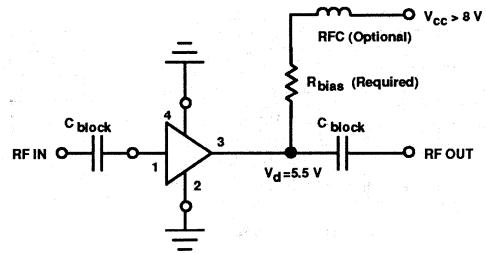

Electrical Specifications¹, $T_A = 25^\circ\text{C}$

Symbol	Parameters and Test Conditions: $I_d = 35 \text{ mA}, Z_0 = 50 \Omega$	Units	Min.	Typ.	Max.	
G_p	Power Gain ($ S_{21} ^2$)	$f = 100 \text{ MHz}$	dB	30	32.5	35
ΔG_p	Gain Flatness	$f = 10 \text{ to } 250 \text{ MHz}$	dB		± 0.5	
$f_3 \text{ dB}$	3 dB Bandwidth ²		MHz		500	
ISO	Reverse Isolation ($ S_{12} ^2$)	$f = 10 \text{ to } 250 \text{ MHz}$	dB		39	
VSWR	Input VSWR	$f = 10 \text{ to } 250 \text{ MHz}$			1.6:1	
	Output VSWR	$f = 10 \text{ to } 250 \text{ MHz}$			1.5:1	
NF	50 Ω Noise Figure	$f = 100 \text{ MHz}$	dB		2.0	2.5
$P_1 \text{ dB}$	Output Power at 1 dB Gain Compression	$f = 100 \text{ MHz}$	dBm		11	
IP_3	Third Order Intercept Point	$f = 100 \text{ MHz}$	dBm		23	
t_D	Group Delay	$f = 100 \text{ MHz}$	psec		200	
V_d	Device Voltage		V	4.0	5.5	7.0
dV/dT	Device Voltage Temperature Coefficient		mV/°C		+10	

Notes: 1. The recommended operating current range for this device is 30 to 40 mA. Typical performance as a function of current is on the following page.
 2. Referenced from 10 MHz Gain (G_p).

INA-01170 Low Noise, Cascadable Silicon Bipolar MMIC Amplifier

Absolute Maximum Ratings

Parameter	Absolute Maximum ¹
Device Current	50 mA
Power Dissipation ^{2,3}	400 mW
RF Input Power	+13 dBm
Junction Temperature	200°C
Storage Temperature	-65°C to 200°C
Thermal Resistance ^{2,4} : $\theta_{JC} = 140^\circ\text{C}/\text{W}$	

Notes:

- Permanent damage may occur if any of these limits are exceeded.
- TCASE = 25°C
- Derate at 7.1 mW/°C for TC > 144°C.
- See MEASUREMENTS section "Thermal Resistance" for more information.

Typical Performance, TA = 25°C

(unless otherwise noted)

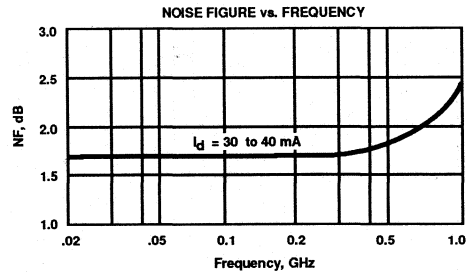
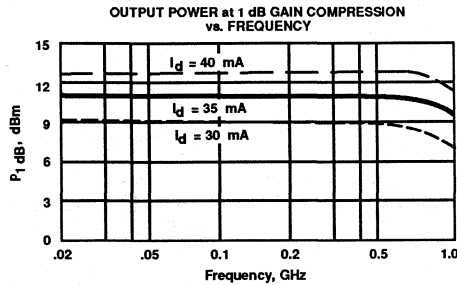
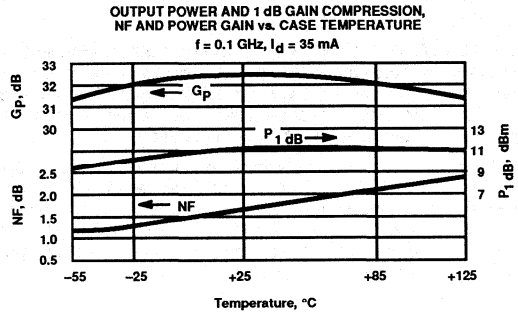
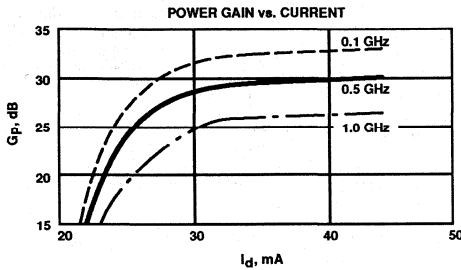
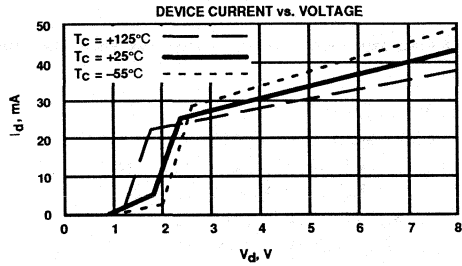

Typical Scattering Parameters: ZO = 50 Ω

TA = 25°C, Id = 35 mA

Freq. MHz	S ₁₁		S ₂₁			S ₁₂			S ₂₂		k
	Mag	Ang	dB	Mag	Ang	dB	Mag	Ang	Mag	Ang	
10	.09	-20	32.8	43.65	-2	-38.4	.012	-5	.17	-1	1.17
50	.10	-39	32.8	43.51	-9	-38.3	.012	17	.18	0	1.17
100	.13	-65	32.6	42.82	-18	-38.3	.012	-4	.18	1	1.17
150	.17	-83	32.4	41.71	-26	-38.4	.012	17	.19	2	1.18
200	.21	-96	32.1	40.41	-35	-38.6	.012	12	.19	3	1.18
250	.25	-107	31.8	38.93	-43	-39.0	.011	26	.19	4	1.26
300	.28	-115	31.5	37.38	-50	-39.0	.011	3	.20	5	1.26
400	.33	-130	30.7	34.19	-65	-39.3	.011	21	.21	3	1.31
500	.37	-140	29.9	31.13	-78	-39.2	.011	11	.22	0	1.35
600	.40	-150	29.0	28.30	-90	-38.9	.011	22	.23	-5	1.43
800	.43	-164	27.4	23.48	-112	-38.5	.012	30	.24	-19	1.52
1000	.44	-176	25.8	19.45	-132	-36.5	.015	32	.23	-32	1.49
1500	.44	165	21.8	12.37	-179	-33.6	.020	42	.19	-69	1.75
2000	.44	154	17.9	7.88	146	-33.0	.022	42	.13	-106	2.42
2500	.46	148	14.6	5.36	121	-30.6	.029	36	.12	-151	2.63
3000	.48	139	11.4	3.71	96	-30.0	.032	45	.10	159	3.31

Features

- Cascadable 50 Ω Gain Block
- Low Noise Figure: 2.0 dB typical at 0.5 GHz
- High Gain: 31.5 dB typical at 0.5 GHz
25.0 dB typical at 1.5 GHz
- 3 dB Bandwidth: DC to 1.0 GHz
- Unconditionally Stable ($k > 1$)
- Hermetic Gold-Ceramic Surface Mount Package

Description

Avantek's INA-02170 is a low-noise silicon bipolar Monolithic Microwave Integrated Circuit (MMIC) feedback amplifier housed in a hermetic, high reliability package. It is designed for narrow or wide bandwidth industrial and military applications that require high gain and low noise IF or RF amplification.

The INA series of MMICs is fabricated using Avantek's 10 GHz $f_{r, 25\text{ GHz } f_{\text{MAX}}}$ ISOSAT™-I silicon bipolar process which uses nitride self-alignment, submicrometer lithography, trench isolation, ion implantation, gold metallization and polyimide intermetal dielectric and scratch protection to achieve excellent performance, uniformity and reliability.

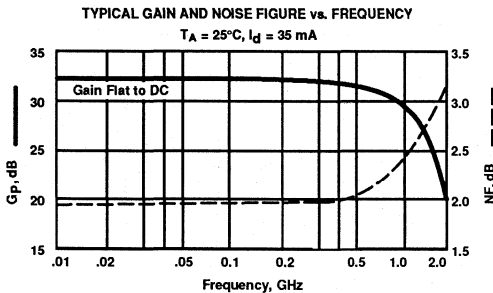
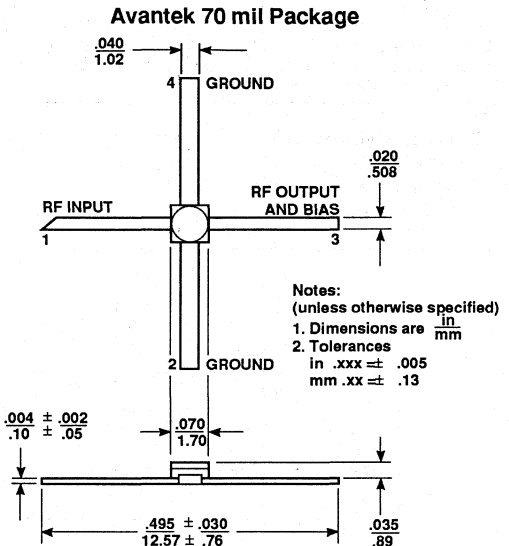

Typical Biasing Configuration

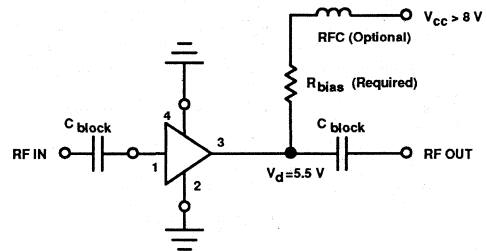

Electrical Specifications¹, TA = 25°C

Symbol	Parameters and Test Conditions: $I_d = 35\text{ mA}$, $Z_0 = 50\ \Omega$	Units	Min.	Typ.	Max.
G_p	Power Gain ($ S_{21} ^2$) $f = 0.5\text{ GHz}$	dB	29.0	31.5	34.0
ΔG_p	Gain Flatness $f = 0.01\text{ to }1.0\text{ GHz}$	dB		± 1.5	
$f_3\text{ dB}$	3 dB Bandwidth ²	GHz		1.0	
ISO	Reverse Isolation ($ S_{12} ^2$) $f = 0.01\text{ to }1.0\text{ GHz}$	dB		39	
VSWR	Input VSWR $f = 0.01\text{ to }1.0\text{ GHz}$			1.4:1	
	Output VSWR $f = 0.01\text{ to }1.0\text{ GHz}$			1.5:1	
NF	50 Ω Noise Figure $f = 0.5\text{ GHz}$	dB		2.0	2.5
$P_1\text{ dB}$	Output Power at 1 dB Gain Compression $f = 0.5\text{ GHz}$	dBm		11	
IP_3	Third Order Intercept Point $f = 0.5\text{ GHz}$	dBm		23	
t_d	Group Delay $f = 0.5\text{ GHz}$	psec		350	
V_d	Device Voltage	V	4.0	5.5	7.0
dV/dT	Device Voltage Temperature Coefficient	$\text{mV}/^\circ\text{C}$		+10	

Notes: 1. The recommended operating current range for this device is 30 to 40 mA. Typical performance as a function of current is on the following page.
 2. Referenced from 10 MHz Gain (G_p).

INA-02170 Low Noise, Cascadable Silicon Bipolar MMIC Amplifier

Absolute Maximum Ratings

Parameter	Absolute Maximum ¹
Device Current	50 mA
Power Dissipation ^{2,3}	400 mW
RF Input Power	+13 dBm
Junction Temperature	200°C
Storage Temperature	-65°C to 200°C

Thermal Resistance^{2,4}: $\theta_{JC} = 140^\circ\text{C/W}$

Notes:

1. Permanent damage may occur if any of these limits are exceeded.
2. $T_{CASE} = 25^\circ\text{C}$
3. Derate at $7.1 \text{ mW}/^\circ\text{C}$ for $T_C > 144^\circ\text{C}$.
4. See MEASUREMENTS section "Thermal Resistance" for more information.

Typical Performance, $T_A = 25^\circ\text{C}$

(unless otherwise noted)

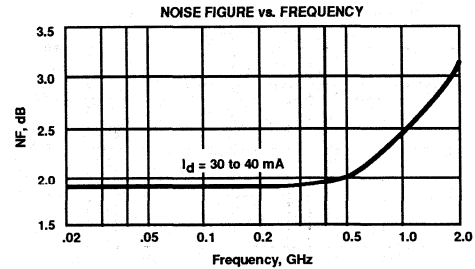
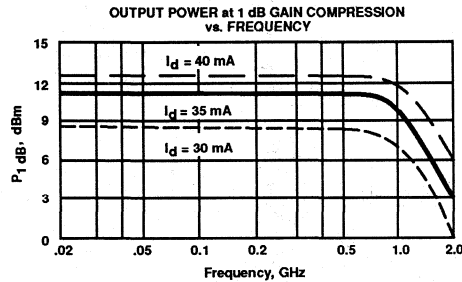
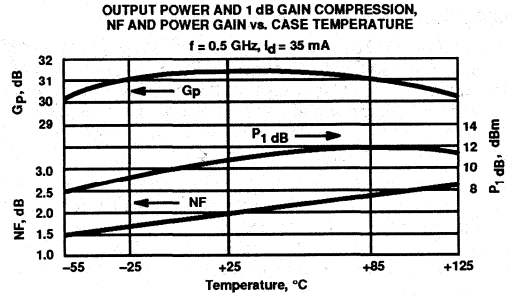
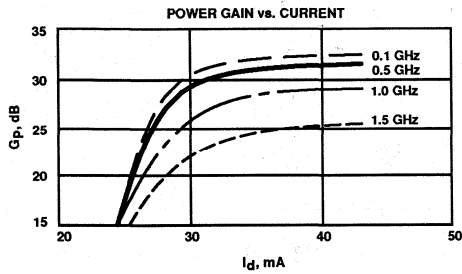
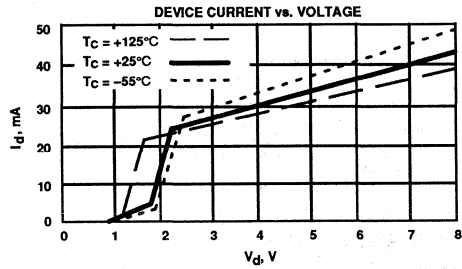

Typical Scattering Parameters: $Z_0 = 50 \Omega$

$T_A = 25^\circ\text{C}, I_d = 35 \text{ mA}$

Freq. GHz	S_{11}		S_{21}			S_{12}			S_{22}		k
	Mag	Ang	dB	Mag	Ang	dB	Mag	Ang	Mag	Ang	
0.01	.05	-8	32.5	42.32	-2	-39.2	.011	14	.19	-1	1.26
0.05	.05	-31	32.5	42.32	-7	-38.9	.011	14	.19	-5	1.26
0.10	.06	-85	32.5	42.05	-14	-38.0	.013	10	.19	-10	1.15
0.20	.09	-110	32.3	41.06	-27	-38.8	.011	5	.18	-16	1.29
0.30	.12	-129	32.0	39.82	-40	-38.8	.011	1	.17	-21	1.32
0.40	.15	-140	31.7	38.43	-53	-40.2	.010	19	.16	-25	1.45
0.50	.17	-151	31.4	37.08	-65	-40.0	.010	8	.16	-27	1.48
0.60	.17	-159	31.0	35.49	-77	-39.6	.011	23	.16	-30	1.43
0.80	.18	-174	30.2	32.45	-101	-38.2	.012	23	.16	-40	1.43
1.00	.19	179	29.2	28.70	-126	-38.2	.012	17	.16	-53	1.55
1.20	.19	173	27.8	24.51	-149	-37.5	.013	27	.15	-71	1.66
1.40	.20	166	26.1	20.18	-171	-36.2	.015	35	.14	-102	1.73
1.60	.21	162	24.2	16.26	170	-36.3	.015	34	.12	-172	2.07
1.80	.22	159	22.3	13.02	153	-34.1	.020	46	.10	144	1.94
2.00	.23	155	20.4	10.45	139	-33.0	.022	37	.07	117	2.17
2.50	.25	150	16.7	6.82	112	-33.3	.022	32	.05	95	3.19
3.00	.29	144	13.1	4.51	87	-31.8	.026	32	.04	78	3.96

Features

- Cascadable 50 Ω Gain Block
- Low Noise Figure: 2.5 dB typical at 1.5 GHz
- High Gain: 26.0 dB typical at 1.5 GHz
- 3 dB Bandwidth: DC to 2.8 GHz
- Unconditionally Stable (k>1)
- Low Power Dissipation
- Hermetic Gold-Ceramic Surface Mount Package

Description

Avantek's INA-03170 is a low-noise silicon bipolar Monolithic Microwave Integrated Circuit (MMIC) feedback amplifier housed in a hermetic, high reliability package. It is designed for narrow or wide bandwidth commercial, industrial and military applications that require high gain and low noise IF or RF amplification with minimum power consumption.

The INA series of MMICs is fabricated using Avantek's 10 GHz f_T , 25 GHz f_{MAX} ISOSAT™-1 silicon bipolar process which uses nitride self-alignment, submicrometer lithography, trench isolation, ion-implantation, gold metallization and polyimide intermetal dielectric and scratch protection to achieve excellent performance, uniformity and reliability.

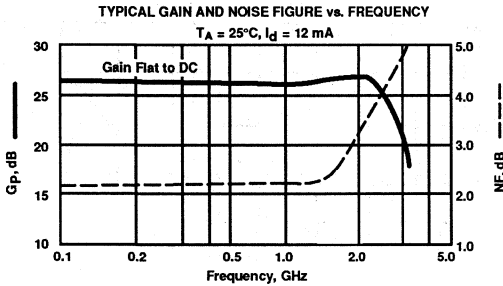
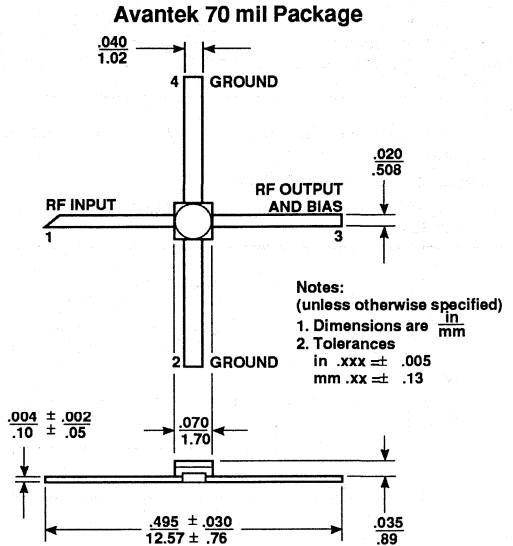

Typical Biasing Configuration

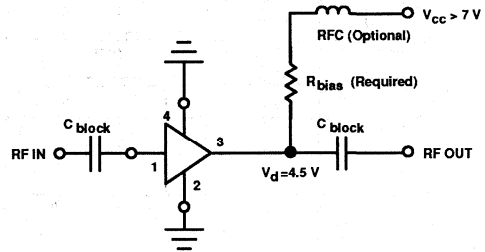

Electrical Specifications¹, $T_A = 25^\circ\text{C}$

Symbol	Parameters and Test Conditions: $I_d = 12\text{ mA}$, $Z_O = 50\ \Omega$	Units	Min.	Typ.	Max.
G_p	Power Gain ($ S_{21} ^2$) $f = 1.5\text{ GHz}$	dB	24.0	26.0	28.0
ΔG_p	Gain Flatness $f = 0.01\text{ to }2.0\text{ GHz}$	dB		± 0.5	
$f_3\text{ dB}$	3 dB Bandwidth ²	GHz		2.8	
ISO	Reverse Isolation ($ S_{12} ^2$) $f = 0.01\text{ to }2.0\text{ GHz}$	dB		37	
VSWR	Input VSWR $f = 0.01\text{ to }2.0\text{ GHz}$			2.0 ³	
	Output VSWR $f = 0.01\text{ to }2.0\text{ GHz}$			3.0 ³	
NF	50 Ω Noise Figure $f = 1.5\text{ GHz}$	dB		2.5	3.0
$P_1\text{ dB}$	Output Power at 1 dB Gain Compression $f = 1.5\text{ GHz}$	dBm		1.0	
IP ₃	Third Order Intercept Point $f = 1.5\text{ GHz}$	dBm		10	
t_D	Group Delay $f = 1.5\text{ GHz}$	psec		200	
V_d	Device Voltage $f = 1.5\text{ GHz}$	V	3.5	4.5	5.5
dV/dT	Device Voltage Temperature Coefficient	mV/°C		+5	

Notes: 1. The recommended operating current range for this device is 8 to 20 mA. Typical performance as a function of current is on the following page.
 2. Referenced from 10 MHz Gain (G_p).
 3. VSWR can be improved by bypassing the bias directly to ground.

Absolute Maximum Ratings

Parameter	Absolute Maximum ¹
Device Current	25 mA
Power Dissipation ^{2,3}	200 mW
RF Input Power	+13 dBm
Junction Temperature	200°C
Storage Temperature	-65°C to 200°C

Thermal Resistance^{2,4}: $\theta_{JC} = 150^\circ\text{C/W}$

Notes:

1. Permanent damage may occur if any of these limits are exceeded.
2. T_{Case} = 25°C
3. Derate at 6.7 mW/°C for T_C > 170°C.
4. See MEASUREMENTS section "Thermal Resistance" for more information.

Typical Performance, T_A = 25°C

(unless otherwise noted)

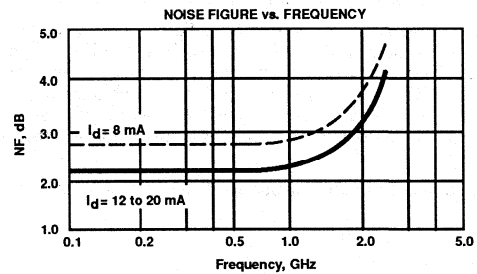
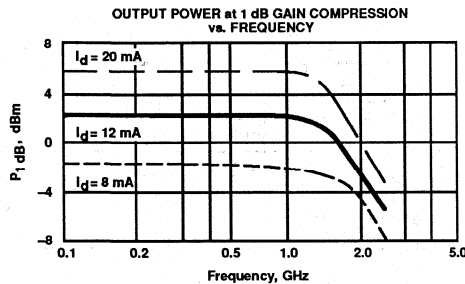
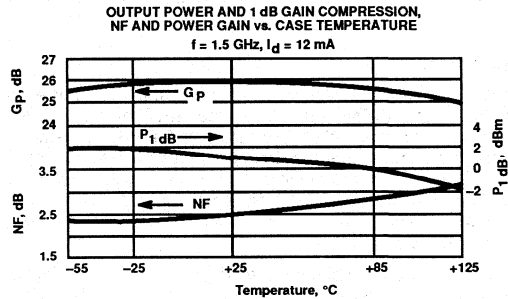
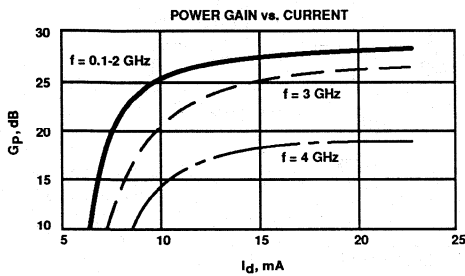
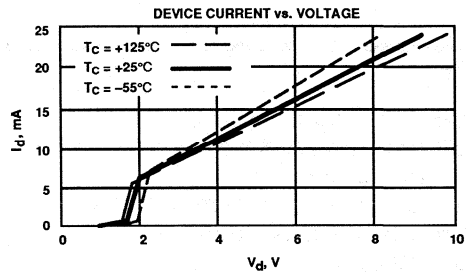

Typical Scattering Parameters: Z₀ = 50 Ω

T_A = 25°C, $I_d = 12$ mA

Freq. GHz	S ₁₁		S ₂₁			S ₁₂			S ₂₂		k
	Mag	Ang	dB	Mag	Ang	dB	Mag	Ang	Mag	Ang	
0.05	.35	178	26.6	21.48	-4	-35.9	.016	9	.56	-1	1.24
0.10	.35	176	26.6	21.42	-7	-36.5	.015	6	.56	-4	1.29
0.20	.34	172	26.6	21.37	-14	-36.5	.015	-1	.56	-7	1.30
0.40	.34	164	26.5	21.19	-28	-36.5	.015	-5	.54	-13	1.33
0.60	.33	158	26.4	20.91	-41	-38.4	.012	2	.53	-18	1.58
0.80	.32	152	26.3	20.69	-54	-37.1	.014	5	.51	-22	1.46
1.00	.32	147	26.2	20.48	-67	-36.5	.015	4	.50	-27	1.41
1.20	.32	141	26.2	20.40	-80	-39.2	.011	13	.49	-32	1.79
1.40	.31	133	26.3	20.73	-93	-37.7	.013	25	.48	-38	1.57
1.60	.31	125	26.5	21.15	-106	-37.1	.014	28	.47	-45	1.47
1.80	.30	117	26.8	21.84	-121	-35.4	.017	30	.46	-52	1.28
2.00	.27	106	26.9	22.20	-138	-37.1	.014	33	.42	-62	1.48
2.50	.15	94	26.6	21.48	-177	-35.4	.017	23	.31	-79	1.44
3.00	.16	159	23.7	15.32	133	-34.4	.019	42	.16	-72	1.78
3.50	.28	150	19.8	9.81	99	-35.4	.017	28	.19	-60	2.71

Features

- 50 MHz to 1.5 GHz Bandwidth
- Data Rates up to 2.0 Gbit/s
- High Gain: 26 dB typical
- Wide Gain Control Range: 30 dB typical
- Differential Output Capability
- Bias $V_{CC}-V_{EE} = 5 V$
- 5 V TTL Compatible V_{GC} Control Voltage, $I_{GC} < 3 mA$
- Hermetic Glass-Metal Surface Mount Package

Description

Avantek's IVA-05118 is a variable gain amplifier housed in a miniature glass-metal hermetic surface mount package. It is designed for narrow or wide bandwidth commercial, industrial and military applications that require high gain and wide gain control range. The amplifier can be used in a single-ended or differential output configuration. For low frequency applications (<50 MHz) a bypass capacitor and series resistor are connected to pin 4, the AC Input Ground lead.

Typical applications include variable gain amplification for fiber-optic systems at data rates in excess of the 1.24 Gb/s SONET standard, mobile radio and satellite receivers, millimeter wave receiver IF amplifiers and communications receivers.

The IVA series of variable gain amplifiers is fabricated using Avantek's 10 GHz f_T , 25 GHz f_{MAX} ISOSAT™-I silicon bipolar process. This process uses nitride self-alignment, sub-micrometer lithography, trench isolation, ion implantation, gold metallization and polyimide inter-metal dielectric and scratch protection to achieve excellent performance, uniformity and reliability.

Differential input option is available. Contact factory for further details.

Avantek 180 mil Package

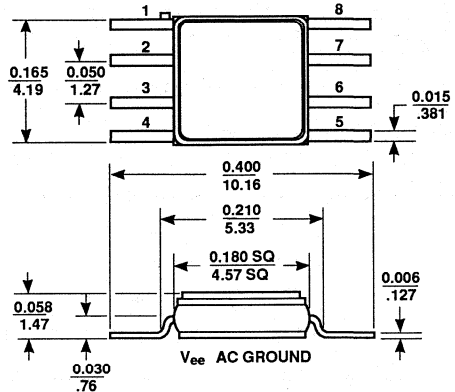

PIN DESCRIPTION	
1 IF Output	8 RF Ground (optional)
2 V_{EE} , AC Ground	7 V_{CC}
3 V_{EE} , AC Ground	6 LO Ground (optional)
4 RF Input	5 LO Input

Bottom of Package is V_{EE} (AC Ground)

Notes:
 (unless otherwise specified)
 1. Dimensions are in mm
 2. Tolerances in .xxx = ±0.005 mm .xx = ±.13

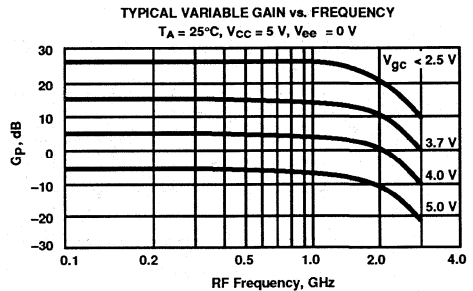

Electrical Specifications¹, $T_A = 25^\circ C$

Symbol	Parameters and Test Conditions ² : $V_{CC} = 5 V$, $V_{EE} = 0 V$, $V_{GC} = 0 V$, $Z_O = 50 \Omega$	Units	Min.	Typ.	Max.
GP	Power Gain $ S_{21} ^2$ $f = 0.5 GHz$	dB	20	26	
ΔGP	Gain Flatness $f = 0.05$ to $1.0 GHz$	dB		±0.3	
f_{3dB}	3 dB Bandwidth ³	GHz	1.0	1.5	
GCR	Gain Control Range $f = 0.5 GHz$, $V_{GC} = 0$ to $5 V$	dB	25	30	
ISO	Reverse Isolation ($ S_{12} ^2$) $f = 0.5 GHz$, $V_{GC} = 0$ to $5 V$	dB		45	
VSWR	Input VSWR $f = 0.05$ to $1.5 GHz$, $V_{GC} = 0$ to $5 V$			1.7:1	
	Output VSWR $f = 0.05$ to $1.5 GHz$, $V_{GC} = 0$ to $5 V$			1.5:1	
NF	50 Ω Noise Figure $f = 0.5 GHz$	dB		9	
P1 dB	Output Power @ 1 dB Compression $f = 0.5 GHz$	dBm		-2	
IP3	Output Third Order Intercept Point $f = 0.5 GHz$	dBm		8	
td	Group Delay $f = 0.5 GHz$	psec		400	
Icc	Supply Current	mA	25	35	45

Notes: 1. The recommended operating voltage range for this device is 4 to 6 V. Typical performance as a function of voltage is on the following page.
 2. As measured using Input Pin 1 and Output Pin 6; with Output Pin 7 terminated into 50 ohms.
 3. Referenced from 50 MHz Gain.

Absolute Maximum Ratings

Parameter	Absolute Maximum ¹
Device Voltage	8 V
Power Dissipation ^{2,3}	600 mW
Input Power	+14 dBm
V _{gc} - V _{ee}	7 V
Junction Temperature	200°C
Storage Temperature	-65°C to 200°C
Thermal Resistance ^{2,4} : $\theta_{jc} = 50^\circ\text{C/W}$	

Notes:

1. Permanent damage may occur if any of these limits are exceeded.
2. T_{CASE} = 25°C
3. Derate at 20 mW/°C for T_C > 170°C.
4. See MEASUREMENTS section "Thermal Resistance" for more information.

Typical Biasing Configuration and Functional Block Diagram

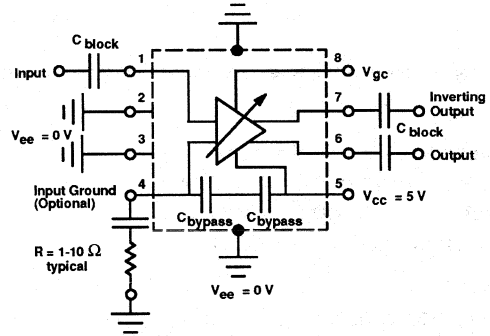

Typical Performance, T_A = 25°C,

V_{cc} = 5 V, V_{ee} = 0 V

(unless otherwise noted)

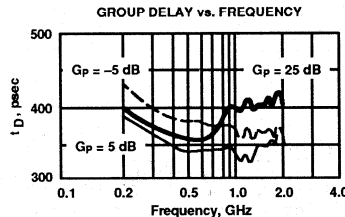
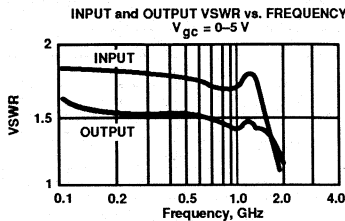
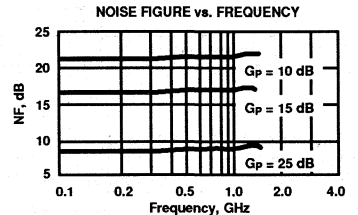
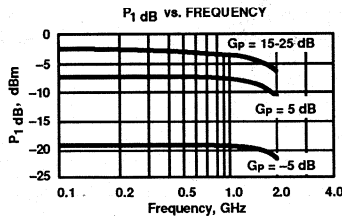
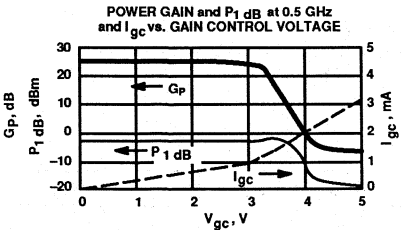
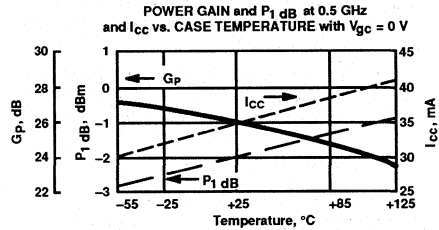
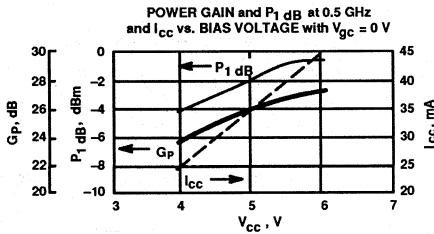

Features

- **Cascadable 50 Ω Gain Block**
- **3 dB Bandwidth: DC to 1.3 GHz**
- **High Gain: 18.5 dB typical at 0.5 GHz**
- **Unconditionally Stable ($k > 1$)**

Description

Avantek's MSA-0100 is a high performance silicon bipolar Monolithic Microwave Integrated Circuit (MMIC) chip. This MODAMP™ MMIC is designed for use as a general purpose 50 Ω gain block. Typical applications include narrow and broad band IF and RF amplifiers in commercial, industrial and military applications.

The MODAMP MSA-series is fabricated using a 10 GHz f_T , 25 GHz f_{MAX} silicon bipolar MMIC process which utilizes nitride self-alignment, ion implantation and gold metallization to achieve excellent uniformity, performance, and reliability. The use of an external bias resistor for temperature and current stability also allows bias flexibility.

The recommended assembly procedure is gold-eutectic die attach at 400°C and either wedge or ball bonding using 0.7 mil gold wire. See APPLICATIONS section, "Chip Use".

Avantek Chip Outline¹

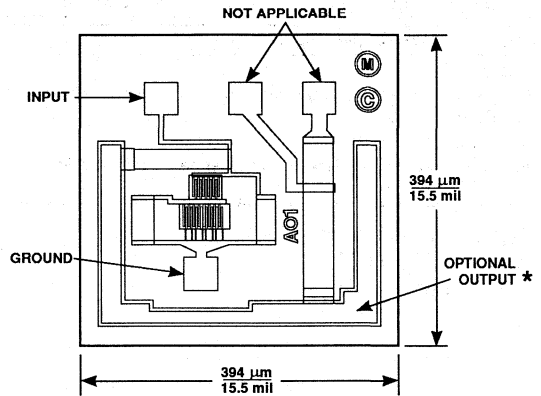

Unless otherwise specified, tolerances are $\pm 13 \mu\text{m} / \pm 0.5 \text{ mils}$.
 Chip thickness is $114 \mu\text{m} / 4.5 \text{ mil}$. Bond pads are $41 \mu\text{m} / 1.6 \text{ mil}$ typical on each side.
 * Output contact is made by die attaching the backside of the die.

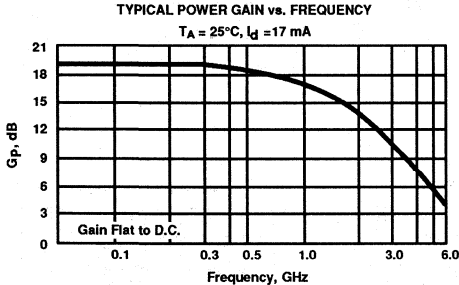

Typical Biasing Configuration

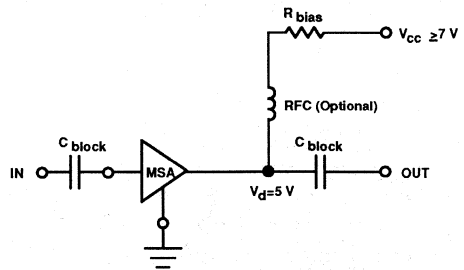

Electrical Specifications², $T_A = 25^\circ\text{C}$

Symbol	Parameters and Test Conditions ³ : $I_d = 17 \text{ mA}, Z_0 = 50 \Omega$	Units	Min.	Typ.	Max.
G_P	Power Gain ($ S_{21} ^2$)	$f = 0.1 \text{ GHz}$		19.0	
ΔG_P	Gain Flatness	$f = 0.1 \text{ to } 0.7 \text{ GHz}$		± 0.6	
$f_3 \text{ dB}$	3 dB Bandwidth			1.3	
VSWR	Input VSWR	$f = 0.1 \text{ to } 3.0 \text{ GHz}$		1.3:1	
	Output VSWR	$f = 0.1 \text{ to } 3.0 \text{ GHz}$		1.3:1	
$P_1 \text{ dB}$	Output Power @ 1 dB Gain Compression	$f = 0.5 \text{ GHz}$		1.5	
NF	50 Ω Noise Figure	$f = 0.5 \text{ GHz}$		5.5	
IP_3	Third Order Intercept Point	$f = 0.5 \text{ GHz}$		14.0	
t_D	Group Delay	$f = 0.5 \text{ GHz}$		150	
V_d	Device Voltage		4.5	5.0	5.5
dV/dT	Device Voltage Temperature Coefficient			-9.0	

Notes: 1. This chip contains additional biasing options. The performance specified applies only to the bias option whose bond pads are indicated on the chip outline. Refer to the APPLICATIONS section "MODAMP™ Silicon MMIC Chip Use" for additional information.
 2. The recommended operating current range for this device is 13 mA to 25 mA. Typical performance as a function of current is on the following page.
 3. RF performance of the chip is determined by packaging and testing 10 devices per wafer in a dual ground configuration.

MSA-0100 MODAMP™ Cascadable Silicon Bipolar Monolithic Microwave Integrated Circuit Amplifiers

Absolute Maximum Ratings

Parameter	Absolute Maximum ¹
Device Current	40 mA
Power Dissipation ^{2,3}	200 mW
RF Input Power	+20 dBm
Junction Temperature	200°C
Storage Temperature	-65°C to 200°C

Thermal Resistance^{2,4}: $\theta_{jc} = 45^\circ\text{C}/\text{W}$

Notes:

1. Permanent damage may occur if any of these limits are exceeded.
2. T_{MOUNTING SURFACE} = 25°C
3. Derate at 22.2 mW/°C for T_{MOUNTING SURFACE} > 191°C.
4. The small spot size of this technique results in a higher, though more accurate determination of θ_{jc} than do alternate methods. See MEASUREMENTS section "Thermal Resistance" for more information.

Part Number Ordering Information

Part Number	Devices Per Tray
MSA-0100-GP2	10
MSA-0100-GP4	100
MSA-0100-GP6	up to 300

Typical Performance, T_A = 25°C

(unless otherwise noted)

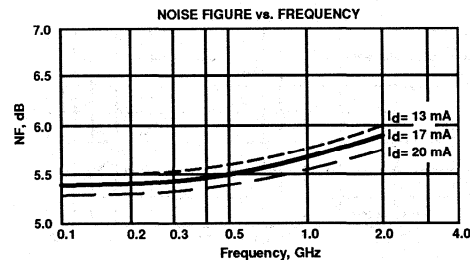
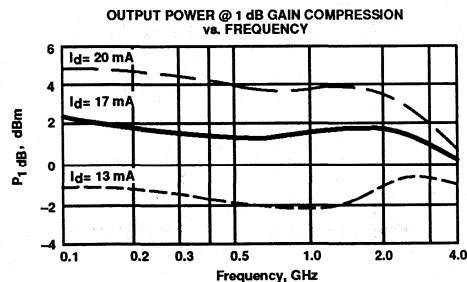
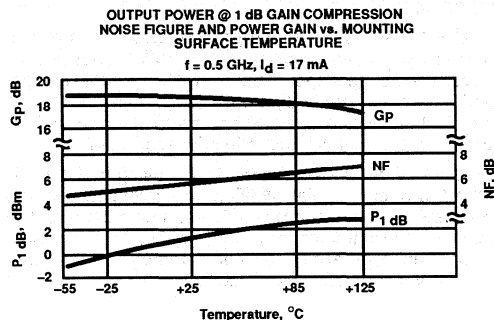
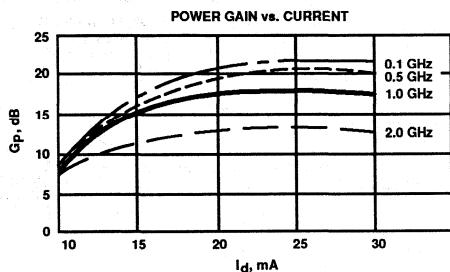

Typical Scattering Parameters⁴: Z₀ = 50 Ω

T_A = 25°C, I_d = 17 mA

Freq. GHz	S ₁₁		S ₂₁			S ₁₂			S ₂₂	
	Mag	Ang	dB	Mag	Ang	dB	Mag	Ang	Mag	Ang
0.1	.08	171	19.0	8.91	174	-22.7	.073	2	.10	-11
0.2	.07	161	18.9	8.82	169	-22.5	.075	6	.11	-24
0.3	.07	152	18.8	8.72	163	-22.3	.077	9	.10	-35
0.4	.06	143	18.6	8.56	156	-22.4	.076	12	.11	-44
0.5	.06	133	18.5	8.37	151	-22.1	.079	14	.11	-53
0.6	.05	115	18.2	8.15	146	-21.9	.080	19	.12	-60
0.8	.04	84	17.7	7.68	136	-21.3	.086	22	.12	-75
1.0	.04	3	17.1	7.17	126	-20.3	.096	26	.12	-88
1.5	.08	-39	15.5	5.95	106	-19.3	.109	32	.10	-107
2.0	.12	-76	13.7	4.86	90	-17.9	.127	32	.08	-128
2.5	.15	-102	12.2	4.09	82	-16.9	.142	36	.06	-130
3.0	.19	-122	10.8	3.47	71	-16.4	.151	36	.06	-125
3.5	.25	-137	9.4	2.96	60	-15.6	.165	34	.07	-107
4.0	.27	-147	8.2	2.56	51	-15.2	.173	32	.10	-86
4.5	.28	-157	7.0	2.24	42	-14.8	.182	29	.13	-80
5.0	.28	-171	6.0	2.00	35	-14.4	.190	28	.16	-77

Note: 4. S-parameters are de-embedded from 70 mil package measured data using the package model found in the DEVICE MODELS section.

Features

- Cascadable 50 Ω Gain Block
- 3 dB Bandwidth: DC to 0.8 GHz
- High Gain: 17.0 dB typical at 0.5 GHz
- Unconditionally Stable ($k > 1$)
- Low Cost Plastic Package

Description

Avantek's MSA-0104 is a high performance silicon bipolar Monolithic Microwave Integrated Circuit (MMIC) housed in a low cost plastic package. This MODAMP™ MMIC is designed for use as a general purpose 50 Ω gain block. Typical applications include narrow and broad band IF and RF amplifiers in commercial and industrial applications.

The MODAMP MSA-series is fabricated using a 10 GHz f_r , 25 GHz f_{MAX} silicon bipolar MMIC process which utilizes nitride self-alignment, ion implantation and gold metallization to achieve excellent uniformity, performance, and reliability. The use of an external bias resistor for temperature and current stability also allows bias flexibility.

Avantek 04 Plastic Package

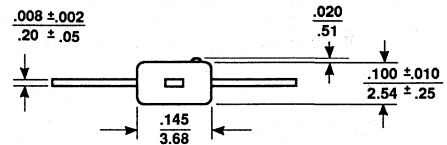
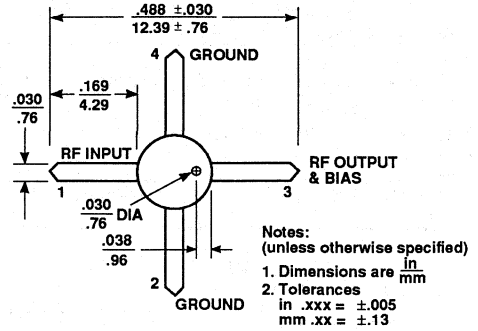

TYPICAL POWER GAIN vs. FREQUENCY

$T_A = 25^\circ\text{C}, I_d = 17\text{ mA}$

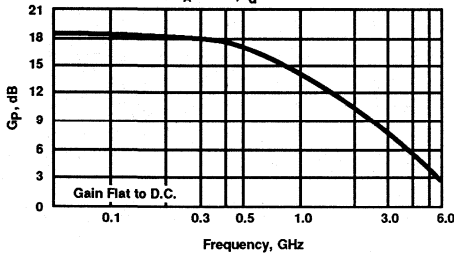

Typical Biasing Configuration

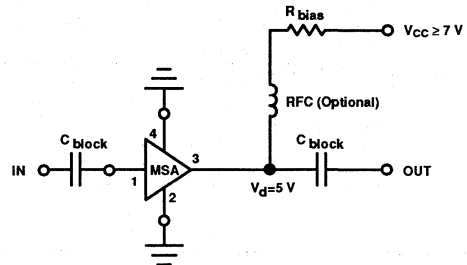

Electrical Specifications¹, $T_A = 25^\circ\text{C}$

Symbol	Parameters and Test Conditions: $I_d = 17\text{ mA}, Z_O = 50\ \Omega$	Units	Min.	Typ.	Max.
G_p	Power Gain ($ S_{21} ^2$) $f = 0.1\text{ GHz}$ $f = 0.5\text{ GHz}$	dB	17.0	18.5 17.0	
ΔG_p	Gain Flatness $f = 0.1\text{ to }0.6\text{ GHz}$	dB		±1.0	
$f_3\text{ dB}$	3 dB Bandwidth	GHz		0.8	
VSWR	Input VSWR $f = 0.1\text{ to }3.0\text{ GHz}$			1.4:1	
	Output VSWR $f = 0.1\text{ to }3.0\text{ GHz}$			1.3:1	
$P_1\text{ dB}$	Output Power @ 1 dB Gain Compression $f = 0.5\text{ GHz}$	dBm		1.5	
NF	50 Ω Noise Figure $f = 0.5\text{ GHz}$	dB		5.5	
IP_3	Third Order Intercept Point $f = 0.5\text{ GHz}$	dBm		14.0	
t_D	Group Delay $f = 0.5\text{ GHz}$	psec		180	
V_d	Device Voltage	V	4.5	5.0	5.5
dV/dT	Device Voltage Temperature Coefficient	mV/°C		-9.0	

Note: 1. The recommended operating current range for this device is 13 mA to 25 mA. Typical performance as a function of current is on the following page.

MSA-0104 MODAMP™ Cascadable Silicon Bipolar Monolithic Microwave Integrated Circuit Amplifiers

Absolute Maximum Ratings

Parameter	Absolute Maximum ¹
Device Current	40 mA
Power Dissipation ^{2,3}	200 mW
RF Input Power	+20 dBm
Junction Temperature	150°C
Storage Temperature	-65°C to 150°C

Thermal Resistance^{2,4}: $\theta_{jc} = 100^\circ\text{C}/\text{W}$

Notes:

- Permanent damage may occur if any of these limits are exceeded.
- TCASE = 25°C
- Derate at 10 mW/°C for TC > 130°C.
- See MEASUREMENTS section "Thermal Resistance" for more information.

Typical Performance, T_A = 25°C

(unless otherwise noted)

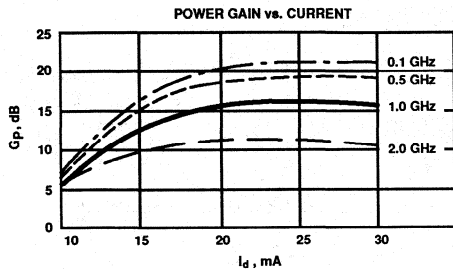
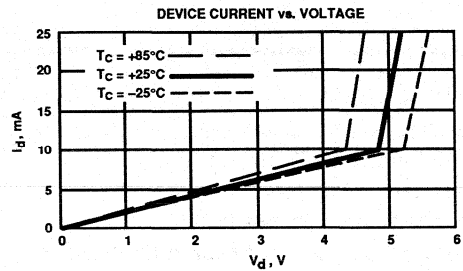

OUTPUT POWER @ 1 dB GAIN COMPRESSION
NOISE FIGURE AND POWER GAIN vs. CASE TEMPERATURE
f = 0.5 GHz, Id = 17 mA

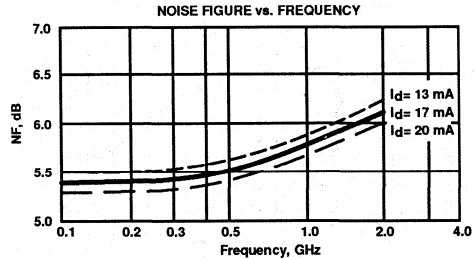
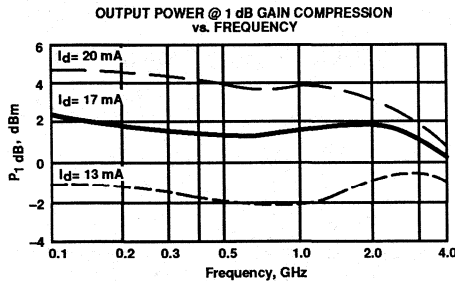
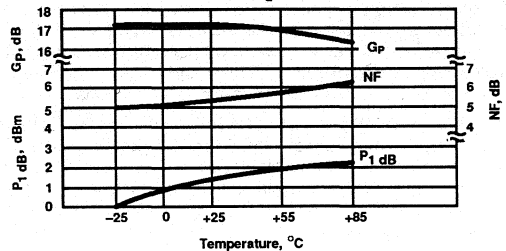

Typical Scattering Parameters: Z₀ = 50 Ω

T_A = 25°C, I_d = 17 mA

Freq. GHz	S ₁₁		S ₂₁			S ₁₂			S ₂₂	
	Mag	Ang	dB	Mag	Ang	dB	Mag	Ang	Mag	Ang
0.1	.06	141	18.4	8.31	170	-22.3	.077	5	.07	-9
0.2	.08	112	18.1	8.07	160	-22.3	.077	9	.07	-15
0.3	.10	94	17.8	7.75	151	-22.0	.079	15	.07	-22
0.4	.12	77	17.4	7.38	142	-21.6	.083	16	.07	-32
0.5	.13	70	16.9	7.01	134	-21.0	.089	19	.07	-37
0.6	.14	56	16.4	6.60	127	-20.7	.092	21	.08	-44
0.8	.16	41	15.4	5.87	114	-19.5	.106	27	.08	-53
1.0	.17	28	14.3	5.21	102	-18.9	.114	29	.08	-61
1.5	.17	5	12.1	4.02	78	-16.6	.148	30	.08	-73
2.0	.13	-12	10.2	3.25	59	-14.9	.179	25	.07	-90
2.5	.08	-20	8.9	2.77	46	-13.6	.209	25	.05	-112
3.0	.02	-37	7.7	2.42	31	-12.7	.232	18	.05	-134
3.5	.05	128	6.7	2.15	15	-11.9	.253	10	.06	-160
4.0	.12	113	5.7	1.92	-1	-11.3	.272	2	.06	-175
4.5	.19	97	4.8	1.73	-15	-10.8	.289	-7	.07	173
5.0	.27	80	3.9	1.56	-30	-10.6	.294	-15	.07	150

A model for this device is available in the DEVICE MODELS section.

Features

- Cascadable 50 Ω Gain Block
- 3 dB Bandwidth: DC to 1.2 GHz
- High Gain: 18.5 dB typical at 0.5 GHz
- Unconditionally Stable ($k > 1$)
- Cost Effective Ceramic Microstrip Package

Description

Avantek's MSA-0135 is a high performance silicon bipolar Monolithic Microwave Integrated Circuit (MMIC) housed in a cost effective, microstrip package. This MODAMP™ MMIC is designed for use as a general purpose 50 Ω gain block. Typical applications include narrow and broad band IF and RF amplifiers in industrial and military applications.

The MODAMP MSA-series is fabricated using a 10 GHz f_T , 25 GHz f_{MAX} silicon bipolar MMIC process which utilizes nitride self-alignment, ion implantation and gold metallization to achieve excellent uniformity, performance, and reliability. The use of an external bias resistor for temperature and current stability also allows bias flexibility.

Avantek 35 micro-X Package¹

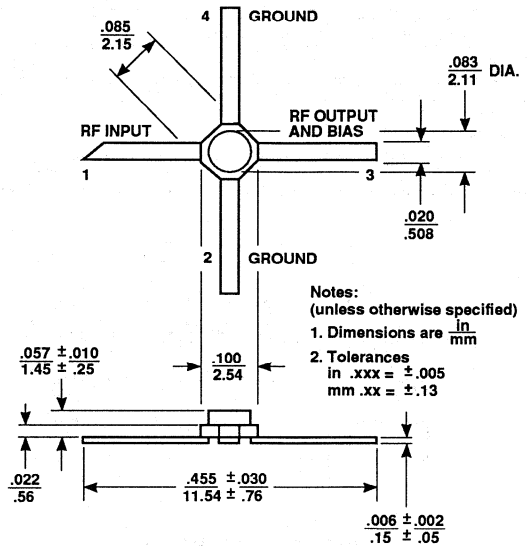

TYPICAL POWER GAIN vs. FREQUENCY

$T_A = 25^\circ\text{C}, I_d = 17\text{ mA}$

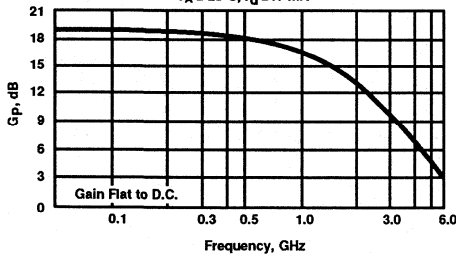

Typical Biasing Configuration

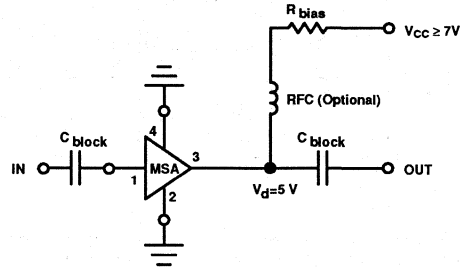

Electrical Specifications², $T_A = 25^\circ\text{C}$

Symbol	Parameters and Test Conditions: $I_d = 17\text{ mA}, Z_0 = 50\ \Omega$	Units	Min.	Typ.	Max.
G_p	Power Gain ($ S_{21} ^2$) $f = 0.1\text{ GHz}$	dB	18.0	19.0	20.0
ΔG_p	Gain Flatness $f = 0.1\text{ to }0.6\text{ GHz}$	dB		±0.6	±1.0
$f_3\text{ dB}$	3 dB Bandwidth	GHz		1.2	
VSWR	Input VSWR $f = 0.1\text{ to }3.0\text{ GHz}$			1.3:1	
	Output VSWR $f = 0.1\text{ to }3.0\text{ GHz}$			1.3:1	
$P_1\text{ dB}$	Output Power @ 1 dB Gain Compression $f = 0.5\text{ GHz}$	dBm		1.5	
NF	50 Ω Noise Figure $f = 0.5\text{ GHz}$	dB		5.5	
IP_3	Third Order Intercept Point $f = 0.5\text{ GHz}$	dBm		14.0	
t_D	Group Delay $f = 0.5\text{ GHz}$	psec.		160	
V_d	Device Voltage	V	4.5	5.0	5.5
dV/dT	Device Voltage Temperature Coefficient	mV/°C		-9.0	

Notes: 1. Short leaded 36 package available upon request.
 2. The recommended operating current range for this device is 13 mA to 25 mA. Typical performance as a function of current is on the following page.

MSA-0135 MODAMP™ Cascadable Silicon Bipolar Monolithic Microwave Integrated Circuit Amplifiers

Absolute Maximum Ratings

Parameter	Absolute Maximum ¹
Device Current	40 mA
Power Dissipation ^{2,3}	200 mW
RF Input Power	+20 dBm
Junction Temperature	200°C
Storage Temperature ⁴	-65°C to 200°C

Thermal Resistance^{2,5}: $\theta_{jc} = 150^\circ\text{C/W}$

Notes:

- Permanent damage may occur if any of these limits are exceeded.
- TCASE = 25°C
- Derate at 6.7 mW/°C for $T_C > 170^\circ\text{C}$.
- Storage above +150°C may tarnish the leads of this package making it difficult to solder into a circuit.
- The small spot size of this technique results in a higher, though more accurate determination of θ_{jc} than do alternate methods. See MEASUREMENTS section "Thermal Resistance" for more information.

Typical Performance, $T_A = 25^\circ\text{C}$

(unless otherwise noted)

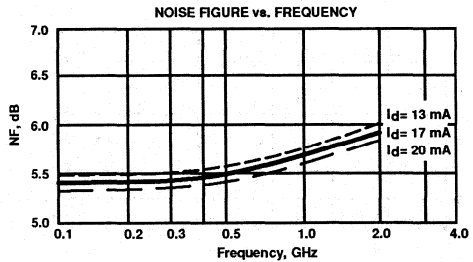
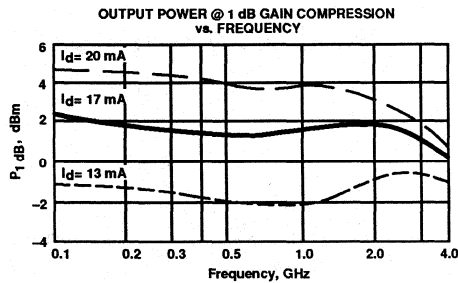
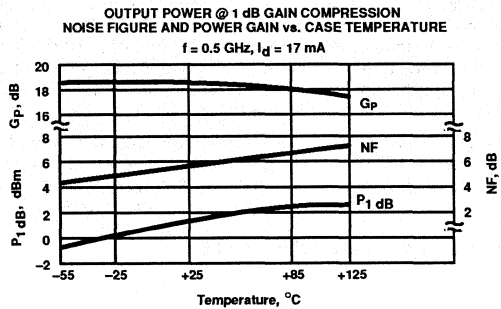
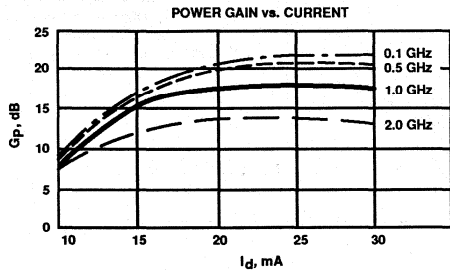
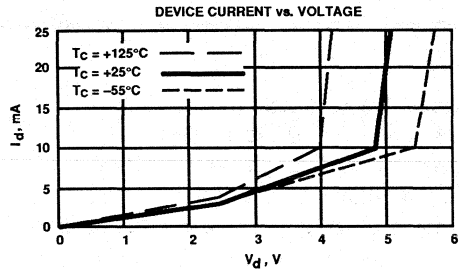

Typical Scattering Parameters: $Z_0 = 50 \Omega$

$T_A = 25^\circ\text{C}, I_d = 17 \text{ mA}$

Freq. GHz	S_{11}		S_{21}			S_{12}			S_{22}	
	Mag	Ang	dB	Mag	Ang	dB	Mag	Ang	Mag	Ang
0.1	.08	158	19.1	9.01	172	-23.0	.071	3	.07	-2
0.2	.08	134	18.9	8.84	165	-22.4	.076	6	.07	-10
0.3	.08	116	18.7	8.65	157	-22.5	.075	12	.07	-10
0.4	.08	97	18.5	8.40	150	-22.2	.078	13	.07	-15
0.5	.09	83	18.2	8.13	143	-21.7	.082	16	.07	-17
0.6	.09	68	17.9	7.84	136	-21.6	.083	17	.07	-21
0.8	.11	47	17.2	7.25	125	-20.7	.092	22	.07	-30
1.0	.11	27	16.5	6.64	113	-19.9	.101	23	.07	-34
1.5	.11	-18	14.6	5.37	90	-18.3	.122	27	.06	-34
2.0	.09	-62	12.8	4.38	70	-16.8	.144	24	.05	-39
2.5	.08	-114	11.3	3.67	58	-16.1	.157	24	.03	-61
3.0	.12	-158	10.0	3.15	43	-15.0	.177	20	.03	-67
3.5	.18	178	8.7	2.72	28	-14.5	.189	14	.05	-88
4.0	.21	163	7.5	2.37	15	-14.0	.200	9	.10	-92
4.5	.23	145	6.4	2.10	2	-13.4	.213	4	.14	-99
5.0	.27	125	5.5	1.88	-10	-13.2	.220	-2	.15	-102

A model for this device is available in the DEVICE MODELS section.

Features

- Cascadable 50 Ω Gain Block
- 3 dB Bandwidth: DC to 1.3 GHz
- High Gain: 18.5 dB typical at 0.5 GHz
- Unconditionally Stable ($k > 1$)
- Hermetic Gold-ceramic Microstrip Package

Description

Avantek's MSA-0170 is a high performance silicon bipolar Monolithic Microwave Integrated Circuit (MMIC) housed in a hermetic high reliability package. This MODAMP™ MMIC is designed for use as a general purpose 50 Ω gain block. Typical applications include narrow and broad band IF and RF amplifiers in industrial and military applications.

The MODAMP MSA-series is fabricated using a 10 GHz f_T , 25 GHz f_{MAX} silicon bipolar MMIC process which utilizes nitride self-alignment, ion implantation and gold metallization to achieve excellent uniformity, performance, and reliability. The use of an external bias resistor for temperature and current stability also allows bias flexibility.

Avantek 70 mil Package

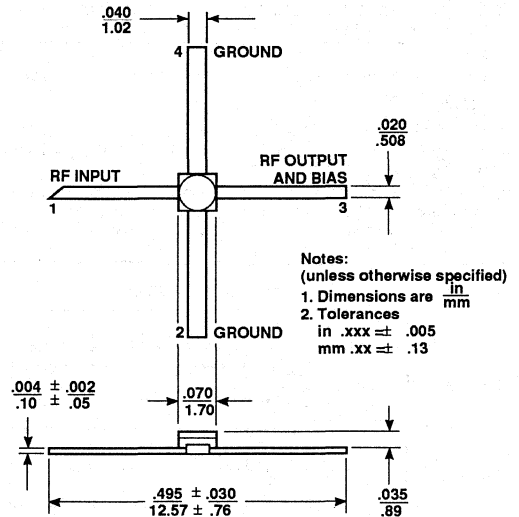

TYPICAL POWER GAIN vs. FREQUENCY
 $T_A = 25^\circ\text{C}, I_d = 17 \text{ mA}$

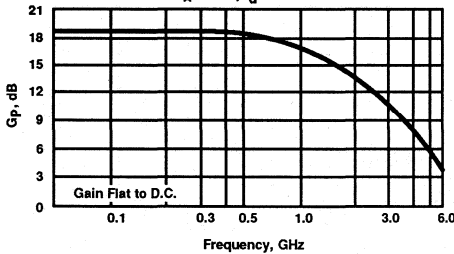

Typical Biasing Configuration

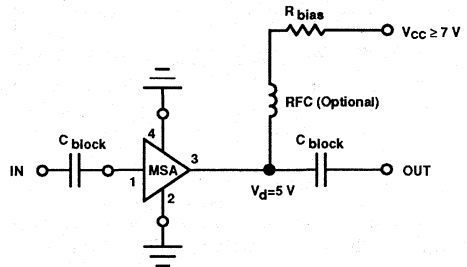

Electrical Specifications¹, $T_A = 25^\circ\text{C}$

Symbol	Parameters and Test Conditions: $I_d = 17 \text{ mA}, Z_0 = 50 \Omega$	Units	Min.	Typ.	Max.
G_P	Power Gain ($ S_{21} ^2$) $f = 0.1 \text{ GHz}$	dB	18.0	19.0	20.0
ΔG_P	Gain Flatness $f = 0.1 \text{ to } 0.7 \text{ GHz}$	dB		± 0.6	± 1.0
$f_{3 \text{ dB}}$	3 dB Bandwidth	GHz		1.3	
VSWR	Input VSWR $f = 0.1 \text{ to } 3.0 \text{ GHz}$			1.3:1	
	Output VSWR $f = 0.1 \text{ to } 3.0 \text{ GHz}$			1.3:1	
$P_1 \text{ dB}$	Output Power @ 1 dB Gain Compression $f = 0.5 \text{ GHz}$	dBm		1.5	
NF	50 Ω Noise Figure $f = 0.5 \text{ GHz}$	dB		5.5	
IP_3	Third Order Intercept Point $f = 0.5 \text{ GHz}$	dBm		14.0	
t_D	Group Delay $f = 0.5 \text{ GHz}$	psec.		150	
V_d	Device Voltage	V	4.5	5.0	5.5
dV/dT	Device Voltage Temperature Coefficient	mV/°C		-9.0	

Note: 1. The recommended operating current range for this device is 13 mA to 25 mA. Typical performance as a function of current is on the following page.

MSA-0170 MODAMP™ Cascadable Silicon Bipolar Monolithic Microwave Integrated Circuit Amplifiers

Absolute Maximum Ratings

Parameter	Absolute Maximum ¹
Device Current	40 mA
Power Dissipation ^{2,3}	200 mW
RF Input Power	+20 dBm
Junction Temperature	200°C
Storage Temperature	-65°C to 200°C

Thermal Resistance^{2,4}: $\theta_{jc} = 125^\circ\text{C/W}$

Notes:

1. Permanent damage may occur if any of these limits are exceeded.
2. TCASE = 25°C
3. Derate at 8 mW/°C for TC > 175°C.
4. The small spot size of this technique results in a higher, though more accurate determination of θ_{jc} than do alternate methods. See MEASUREMENTS section "Thermal Resistance" for more information.

Typical Performance, T_A = 25°C

(unless otherwise noted)

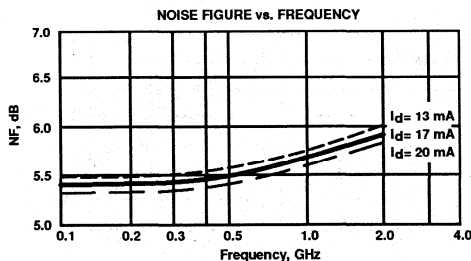
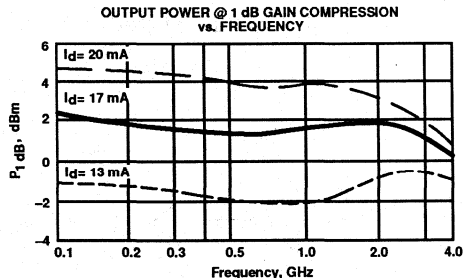
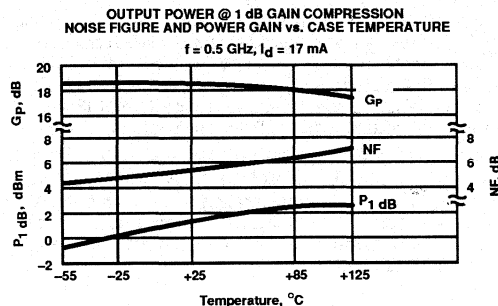
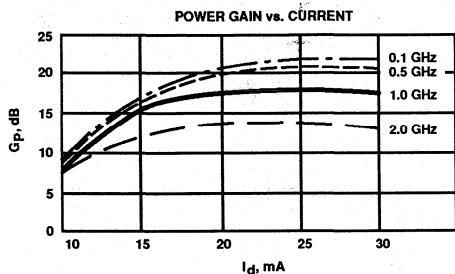
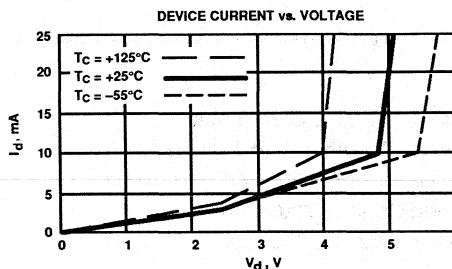

Typical Scattering Parameters: Z₀ = 50 Ω

T_A = 25°C, I_d = 17 mA

Freq. GHz	S ₁₁		S ₂₁			S ₁₂			S ₂₂	
	Mag	Ang	dB	Mag	Ang	dB	Mag	Ang	Mag	Ang
0.1	.08	171	19.0	8.88	173	-22.7	.073	2	.10	-13
0.2	.07	161	18.9	8.77	167	-22.5	.075	6	.11	-27
0.3	.07	152	18.7	8.64	160	-22.3	.077	8	.10	-39
0.4	.06	143	18.5	8.45	153	-22.4	.076	11	.11	-49
0.5	.05	133	18.3	8.23	147	-22.0	.079	13	.11	-59
0.6	.04	115	18.0	7.98	141	-21.8	.081	17	.12	-67
0.8	.03	79	17.5	7.46	130	-21.2	.087	20	.12	-83
1.0	.04	-14	16.8	6.90	119	-20.2	.098	23	.12	-96
1.5	.08	-52	15.0	5.64	96	-19.0	.112	26	.10	-116
2.0	.12	-87	13.2	4.58	78	-17.7	.131	24	.08	-134
2.5	.15	-112	11.7	3.85	67	-16.7	.147	25	.07	-135
3.0	.19	-132	10.3	3.27	54	-16.1	.156	22	.07	-129
3.5	.24	-148	8.9	2.80	41	-15.4	.170	18	.09	-117
4.0	.26	-159	7.7	2.43	29	-15.0	.177	13	.13	-106
4.5	.27	-170	6.6	2.14	18	-14.7	.184	8	.17	-105
5.0	.27	175	5.7	1.92	8	-14.3	.192	5	.20	-106

A model for this device is available in the DEVICE MODELS section.

Features

- Cascadable 50 Ω Gain Block
- 3 dB Bandwidth: DC to 1.0 GHz
- High Gain: 17.5 dB typical at 0.5 GHz
- Unconditionally Stable ($k > 1$)
- Low Cost Plastic Package

Description

Avantek's MSA-0185 is a high performance silicon bipolar Monolithic Microwave Integrated Circuit (MMIC) housed in a low cost plastic package. This MODAMP™ MMIC is designed for use as a general purpose 50 Ω gain block. Typical applications include narrow and broad band IF and RF amplifiers in industrial and military applications.

The MODAMP MSA-series is fabricated using a 10 GHz f_T , 25 GHz f_{MAX} silicon bipolar MMIC process which utilizes nitride self-alignment, ion implantation and gold metallization to achieve excellent uniformity, performance, and reliability. The use of an external bias resistor for temperature and current stability also allows bias flexibility.

Avantek 85 Plastic Package

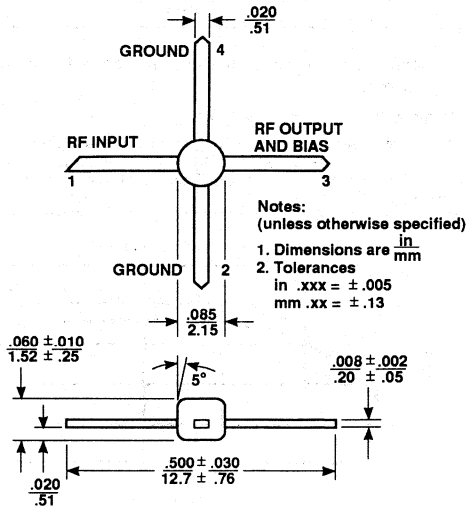

TYPICAL POWER GAIN vs. FREQUENCY

$T_A = 25^\circ\text{C}$, $I_d = 17\text{ mA}$

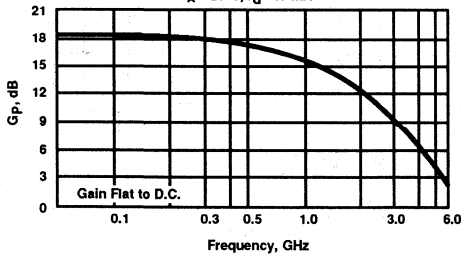

Typical Biasing Configuration

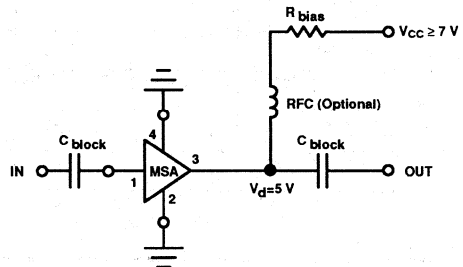

Electrical Specifications¹, $T_A = 25^\circ\text{C}$

Symbol	Parameters and Test Conditions: $I_d = 17\text{ mA}$, $Z_0 = 50\ \Omega$	Units	Min.	Typ.	Max.
GP	Power Gain ($ S_{21} ^2$) $f = 0.1\text{ GHz}$ $f = 0.5\text{ GHz}$	dB	16.0	18.5 17.5	
ΔGP	Gain Flatness $f = 0.1\text{ to }0.6\text{ GHz}$	dB		± 0.6	
$f_3\text{ dB}$	3 dB Bandwidth	GHz		1.0	
VSWR	Input VSWR $f = 0.1\text{ to }3.0\text{ GHz}$			1.3:1	
	Output VSWR $f = 0.1\text{ to }3.0\text{ GHz}$			1.3:1	
$P_{1\text{ dB}}$	Output Power @ 1 dB Gain Compression $f = 0.5\text{ GHz}$	dBm		1.5	
NF	50 Ω Noise Figure $f = 0.5\text{ GHz}$	dB		5.5	
IP_3	Third Order Intercept Point $f = 0.5\text{ GHz}$	dBm		14.0	
t_D	Group Delay $f = 0.5\text{ GHz}$	psec.		150	
V_d	Device Voltage	V	4.0	5.0	6.0
dV/dT	Device Voltage Temperature Coefficient	mV/°C		-9.0	

Note: 1. The recommended operating current range for this device is 13 mA to 25 mA. Typical performance as a function of current is on the following page.

MSA-0185 MODAMP™ Cascadable Silicon Bipolar Monolithic Microwave Integrated Circuit Amplifiers

Absolute Maximum Ratings

Parameter	Absolute Maximum ¹
Device Current	40 mA
Power Dissipation ^{2,3}	200 mW
RF Input Power	+20 dBm
Junction Temperature	150°C
Storage Temperature	-65°C to 150°C

Thermal Resistance^{2,4}: $\theta_{jc} = 105^\circ\text{C/W}$

Notes:

- Permanent damage may occur if any of these limits are exceeded.
- TCASE = 25°C
- Derate at 9.5 mW/°C for TC > 129°C.
- See MEASUREMENTS section "Thermal Resistance" for more information.

Typical Performance, TA = 25°C

(unless otherwise noted)

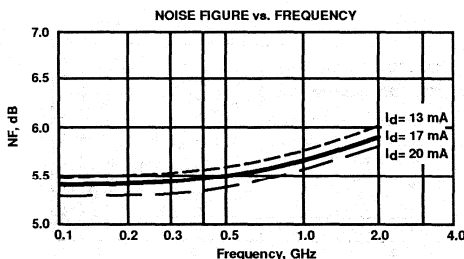
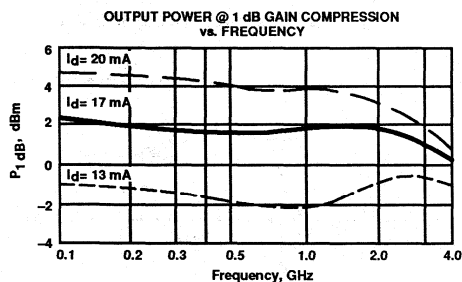
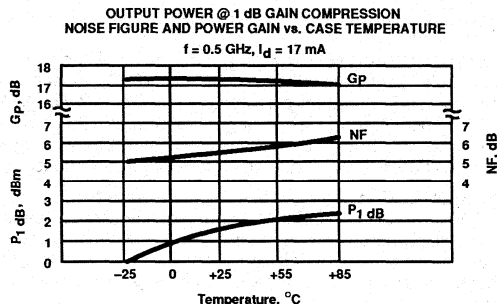
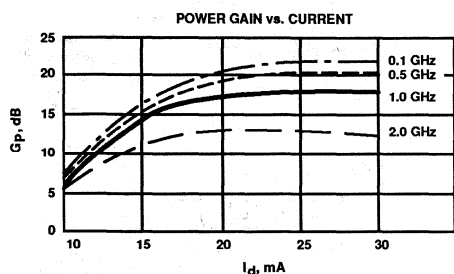
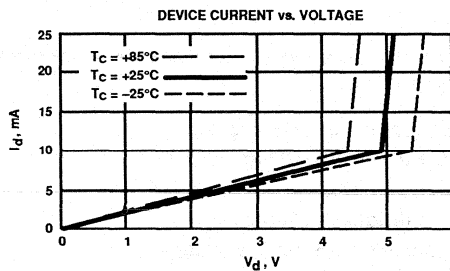

Typical Scattering Parameters: ZO = 50 Ω

TA = 25°C, Id = 17 mA

Freq. GHz	S11		S21			S12			S22	
	Mag	Ang	dB	Mag	Ang	dB	Mag	Ang	Mag	Ang
0.1	.06	166	18.4	8.36	172	-22.6	.074	3	.07	-17
0.2	.06	149	18.3	8.20	165	-22.0	.079	8	.07	-28
0.3	.06	133	18.1	8.01	158	-22.2	.078	11	.08	-43
0.4	.06	120	17.8	7.78	151	-21.9	.080	14	.09	-56
0.5	.06	105	17.5	7.53	144	-21.4	.085	18	.09	-68
0.6	.06	94	17.2	7.23	138	-21.4	.085	19	.09	-75
0.8	.07	72	16.5	6.66	127	-20.7	.092	24	.10	-89
1.0	.07	49	15.7	6.09	116	-19.7	.104	27	.10	-100
1.5	.07	12	13.8	4.89	94	-18.0	.126	32	.11	-120
2.0	.04	-13	12.0	3.98	76	-16.2	.154	31	.11	-134
2.5	.03	-84	10.6	3.38	65	-15.1	.175	33	.11	-138
3.0	.07	-159	9.2	2.88	52	-14.2	.194	29	.09	-146
3.5	.12	-174	8.0	2.50	38	-13.3	.216	24	.08	-135
4.0	.16	170	6.8	2.19	26	-12.8	.229	19	.08	-120
4.5	.21	150	5.7	1.93	14	-12.3	.242	13	.08	-107
5.0	.25	126	4.7	1.72	3	-12.2	.245	-6	.07	-110

A model for this device is available in the DEVICE MODELS section.

Features

- Cascadable 50 Ω Gain Block
- 3 dB Bandwidth: DC to 0.9 GHz
- High Gain: 17.5 dB typical at 0.5 GHz
- Unconditionally Stable ($k > 1$)
- Surface Mount Plastic Package
- Tape-and-Reel Packaging Option Available¹

Description

Avantek's MSA-0186 is a high performance silicon bipolar Monolithic Microwave Integrated Circuit (MMIC) housed in a low cost, surface mount plastic package. This MODAMP™ MMIC is designed for use as a general purpose 50 Ω gain block. Applications include narrow and broad band IF and RF amplifiers in commercial and industrial applications.

The MODAMP MSA-series is fabricated using a 10 GHz f_T , 25 GHz f_{MAX} silicon bipolar MMIC process which utilizes nitride self-alignment, ion implantation and gold metallization to achieve excellent uniformity, performance, and reliability. The use of an external bias resistor for temperature and current stability also allows bias flexibility.

Avantek 86 Plastic Package

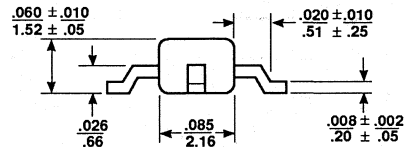
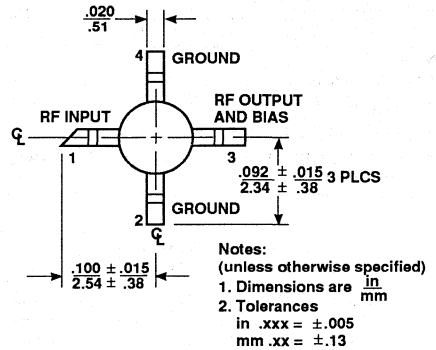

Typical Biasing Configuration

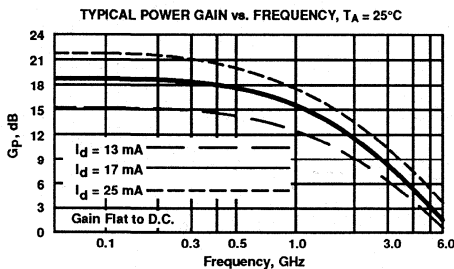
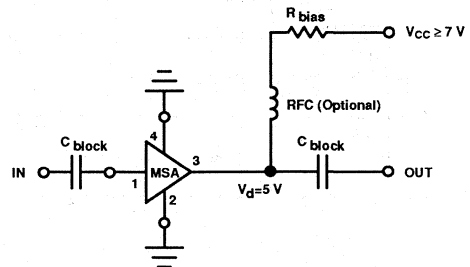

Electrical Specifications², TA = 25°C

Symbol	Parameters and Test Conditions: $I_d = 17 \text{ mA}$, $Z_0 = 50 \Omega$	Units	Min.	Typ.	Max.
G_p	Power Gain ($ S_{21} ^2$) $f = 0.1 \text{ GHz}$ $f = 0.5 \text{ GHz}$	dB	15.5	18.5 17.5	
ΔG_p	Gain Flatness $f = 0.1 \text{ to } 0.6 \text{ GHz}$	dB		± 0.7	
$f_{3 \text{ dB}}$	3 dB Bandwidth	GHz		0.9	
VSWR	Input VSWR $f = 0.1^1 \text{ to } 3.0 \text{ GHz}$			1.3:1	
	Output VSWR $f = 0.1 \text{ to } 3.0 \text{ GHz}$			1.2:1	
$P_{1 \text{ dB}}$	Output Power @ 1 dB Gain Compression $f = 0.5 \text{ GHz}$	dBm		1.5	
NF	50 Ω Noise Figure $f = 0.5 \text{ GHz}$	dB		5.5	
IP_3	Third Order Intercept Point $f = 0.5 \text{ GHz}$	dBm		14.0	
t_D	Group Delay $f = 0.5 \text{ GHz}$	psec.		200	
V_d	Device Voltage	V	4.0	5.0	6.0
dV/dT	Device Voltage Temperature Coefficient	mV/°C		-9.0	

Notes: 1. Refer to PACKAGING section "Tape-and-Reel Packaging for Surface Mount Semiconductors".
 2. The recommended operating current range for this device is 13 mA to 25 mA. Typical performance as a function of current is on the following page.

MSA-0186 MODAMP™ Cascadable Silicon Bipolar Monolithic Microwave Integrated Circuit Amplifiers

Absolute Maximum Ratings

Parameter	Absolute Maximum ¹
Device Current	40 mA
Power Dissipation ^{2,3}	200 mW
RF Input Power	+20 dBm
Junction Temperature	150°C
Storage Temperature	-65°C to 150°C

Thermal Resistance^{2,4}: $\theta_{JC} = 115^\circ\text{C/W}$

Notes:

- Permanent damage may occur if any of these limits are exceeded.
- TCASE = 25°C
- Derate at 8.7 mW/°C for TC > 127°C.
- See MEASUREMENTS section "Thermal Resistance" for more information.

Part Number Ordering Information

Part Number	Devices Per Reel	Reel Size
MSA-0186-TR1	1000	7"
MSA-0186-TR2	4000	13"

Typical Performance, T_A = 25°C

(unless otherwise noted)

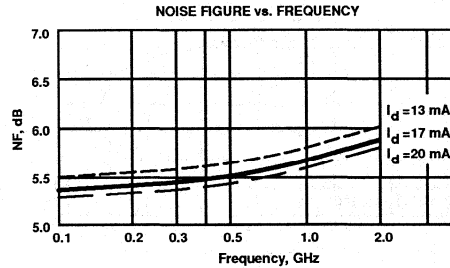
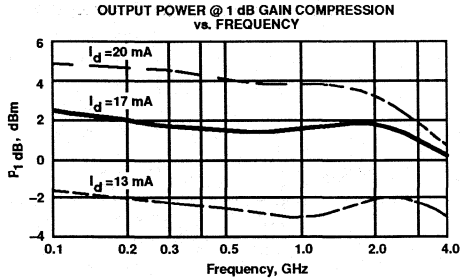
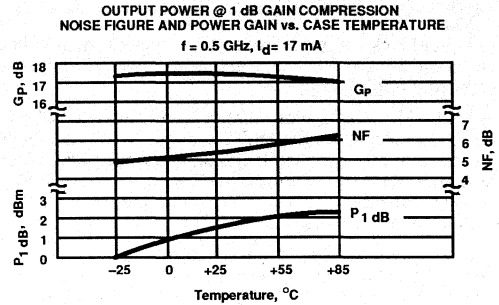
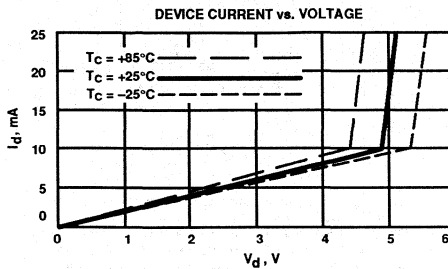

Typical Scattering Parameters: Z₀ = 50 Ω

T_A = 25°C, I_d = 17 mA

Freq. GHz	S ₁₁		S ₂₁			S ₁₂			S ₂₂	
	Mag	Ang	dB	Mag	Ang	dB	Mag	Ang	Mag	Ang
0.1	.05	148	18.5	8.39	171	-23.0	.071	4	.08	-7
0.2	.06	124	18.3	8.22	162	-22.8	.073	9	.08	-14
0.3	.07	103	18.1	8.03	154	-22.6	.074	13	.07	-24
0.4	.08	89	17.7	7.67	146	-22.2	.078	14	.07	-31
0.5	.08	76	17.4	7.42	139	-21.9	.081	17	.06	-39
0.6	.09	66	17.0	7.06	131	-21.4	.085	21	.06	-47
0.8	.10	50	16.2	6.47	119	-20.5	.094	25	.07	-67
1.0	.10	35	15.3	5.83	107	-19.6	.105	29	.07	-89
1.5	.07	12	13.2	4.57	83	-17.7	.131	30	.08	-165
2.0	.02	-12	11.3	3.67	64	-16.1	.157	27	.08	156
2.5	.06	165	9.8	3.09	50	-14.8	.182	24	.08	134
3.0	.14	150	8.3	2.60	34	-13.9	.202	19	.09	124
3.5	.23	137	7.0	2.24	20	-13.4	.213	12	.09	117
4.0	.31	125	5.7	1.93	6	-13.0	.223	5	.09	114
5.0	.45	105	3.3	1.46	-17	-12.7	.231	-5	.09	132

A model for this device is available in the DEVICE MODELS section.

Features

- Cascadable 50 Ω Gain Block
- 3 dB Bandwidth: DC to 2.8 GHz
- 12.0 dB typical Gain at 1.0 GHz
- Unconditionally Stable ($k > 1$)

Description

Avantek's MSA-0200 is a high performance silicon bipolar Monolithic Microwave Integrated Circuit (MMIC) chip. This MODAMP™ MMIC is designed for use as a general purpose 50 Ω gain block. Typical applications include narrow and broad band IF and RF amplifiers in commercial, industrial and military applications.

The MODAMP MSA-series is fabricated using a 10 GHz f_T , 25 GHz f_{MAX} silicon bipolar MMIC process which utilizes nitride self-alignment, ion implantation and gold metallization to achieve excellent uniformity, performance, and reliability. The use of an external bias resistor for temperature and current stability also allows bias flexibility.

The recommended assembly procedure is gold-eutectic die attach at 400°C and either wedge or ball bonding using 0.7 mil gold wire. See APPLICATIONS section, "Chip Use".

Avantek Chip Outline¹

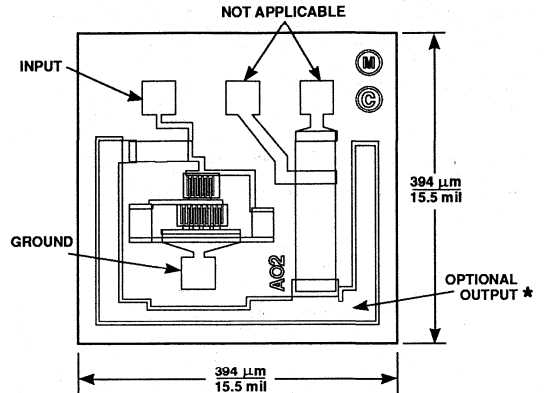

Unless otherwise specified, tolerances are $\pm 13 \mu\text{m} / \pm 0.5 \text{ mils}$.

Chip thickness is 114 $\mu\text{m} / 4.5 \text{ mil}$. Bond pads are 41 $\mu\text{m} / 1.6 \text{ mil}$ typical on each side.

* Output contact is made by die attaching the backside of the die.

TYPICAL POWER GAIN vs. FREQUENCY

$T_A = 25^\circ\text{C}$, $I_d = 25 \text{ mA}$

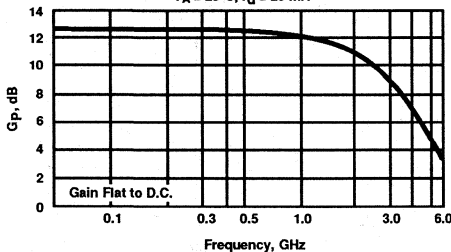

Typical Biasing Configuration

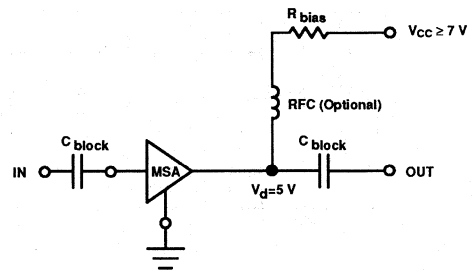

Electrical Specifications², $T_A = 25^\circ\text{C}$

Symbol	Parameters and Test Conditions ³ : $I_d = 25 \text{ mA}$, $Z_0 = 50 \Omega$	Units	Min.	Typ.	Max.
G_p	Power Gain ($ S_{21} ^2$)	$f = 0.1 \text{ GHz}$		12.5	
ΔG_p	Gain Flatness	$f = 0.1 \text{ to } 1.8 \text{ GHz}$		± 0.6	
$f_{3 \text{ dB}}$	3 dB Bandwidth			2.8	
VSWR	Input VSWR	$f = 0.1 \text{ to } 3.0 \text{ GHz}$		1.4:1	
	Output VSWR	$f = 0.1 \text{ to } 3.0 \text{ GHz}$		1.4:1	
$P_1 \text{ dB}$	Output Power @ 1 dB Gain Compression	$f = 1.0 \text{ GHz}$		4.5	
NF	50 Ω Noise Figure	$f = 1.0 \text{ GHz}$		6.5	
IP_3	Third Order Intercept Point	$f = 1.0 \text{ GHz}$		17.0	
t_D	Group Delay	$f = 1.0 \text{ GHz}$		125	
V_d	Device Voltage		4.5	5.0	5.5
dV/dT	Device Voltage Temperature Coefficient			-8.0	

Notes: 1. This chip contains additional biasing options. The performance specified applies only to the bias option whose bond pads are indicated on the chip outline. Refer to the APPLICATIONS section "MODAMP™ Silicon MMIC Chip Use" for additional information.

2. The recommended operating current range for this device is 18 mA to 40 mA. Typical performance as a function of current is on the following page.

3. RF performance of the chip is determined by packaging and testing 10 devices per wafer in a dual ground configuration.

MSA-0200 MODAMP™ Cascadable Silicon Bipolar Monolithic Microwave Integrated Circuit Amplifiers

Absolute Maximum Ratings

Parameter	Absolute Maximum ¹
Device Current	60 mA
Power Dissipation ^{2,3}	325 mW
RF Input Power	+20 dBm
Junction Temperature	200°C
Storage Temperature	-65°C to 200°C

Thermal Resistance^{2,4}: $\theta_{jC} = 35^\circ\text{C}/\text{W}$

Notes:

- Permanent damage may occur if any of these limits are exceeded.
- T_{MOUNTING SURFACE} = 25°C
- Derate at 28.6 mW/°C for T_{MOUNTING SURFACE} > 189°C.
- The small spot size of this technique results in a higher, though more accurate determination of θ_{jC} than do alternate methods. See MEASUREMENTS section "Thermal Resistance" for more information.

Part Number Ordering Information

Part Number	Devices Per Tray
MSA-0200-GP2	10
MSA-0200-GP4	100
MSA-0200-GP6	up to 300

Typical Performance, T_A = 25°C

(unless otherwise noted)

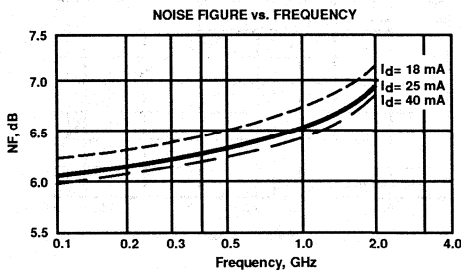
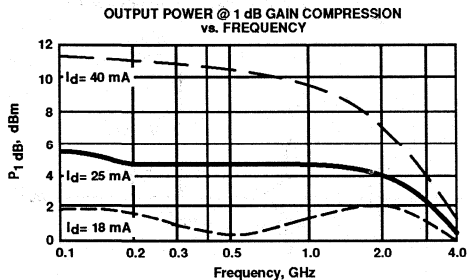
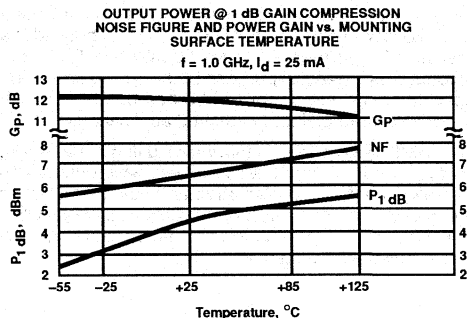
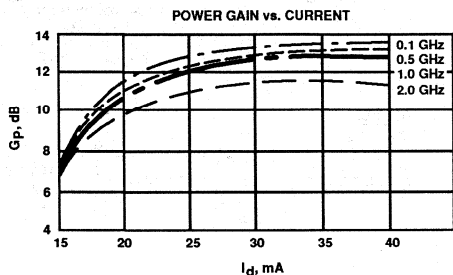

Typical Scattering Parameters⁴: Z₀ = 50 Ω

T_A = 25°C, I_d = 25 mA

Freq. GHz	S ₁₁			S ₂₁			S ₁₂			S ₂₂		
	Mag	Ang	dB	Mag	Ang	dB	Mag	Ang	Mag	Ang	Mag	Ang
0.1	.11	179	12.6	4.27	177	-18.4	.120	1	.11	-7		
0.2	.11	174	12.6	4.26	172	-18.6	.117	4	.11	-12		
0.4	.10	170	12.5	4.24	165	-18.4	.120	5	.12	-25		
0.6	.09	166	12.5	4.22	158	-18.2	.123	7	.13	-38		
0.8	.08	162	12.4	4.17	152	-18.2	.123	10	.13	-47		
1.0	.06	161	12.3	4.13	144	-18.0	.126	13	.14	-55		
1.5	.02	-170	12.0	3.99	126	-17.3	.137	17	.15	-72		
2.0	.05	-105	11.5	3.74	109	-16.4	.152	20	.15	-89		
2.5	.10	-103	10.8	3.46	97	-15.8	.163	25	.13	-91		
3.0	.17	-124	9.8	3.10	83	-15.3	.172	26	.11	-100		
3.5	.22	-137	8.7	2.71	68	-14.7	.184	22	.13	-94		
4.0	.26	-144	7.4	2.35	55	-14.3	.192	22	.16	-85		
5.0	.29	-165	5.1	1.80	35	-13.8	.203	17	.22	-76		
6.0	.33	162	3.3	1.46	20	-13.5	.211	14	.23	-82		

Note: 4. S-parameters are de-embedded from 70 mil package measured data using the package model found in the DEVICE MODELS section.

Features

- Cascadable 50 Ω Gain Block
- 3 dB Bandwidth: DC to 1.8 GHz
- 11.0 dB typical Gain at 1.0 GHz
- Unconditionally Stable ($K > 1$)
- Low Cost Plastic Package

Description

Avantek's MSA-0204 is a high performance silicon bipolar Monolithic Microwave Integrated Circuit (MMIC) housed in a low cost plastic package. This MODAMP™ MMIC is designed for use as a general purpose 50 Ω gain block. Typical applications include narrow and broad band IF and RF amplifiers in commercial and industrial applications.

The MODAMP MSA-series is fabricated using a 10 GHz f_T , 25 GHz f_{MAX} silicon bipolar MMIC process which utilizes nitride self-alignment, ion implantation and gold metallization to achieve excellent uniformity, performance, and reliability. The use of an external bias resistor for temperature and current stability also allows bias flexibility.

Avantek 04 Plastic Package

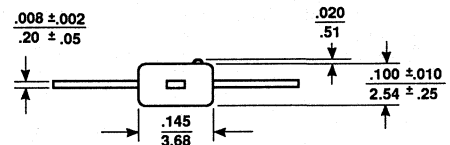
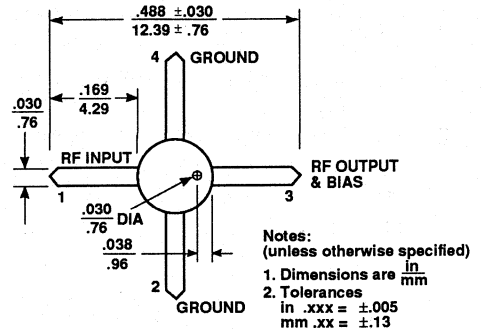

TYPICAL POWER GAIN vs. FREQUENCY

$T_A = 25^\circ C, I_d = 25 \text{ mA}$

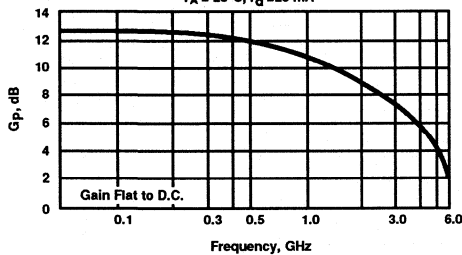

Typical Biasing Configuration

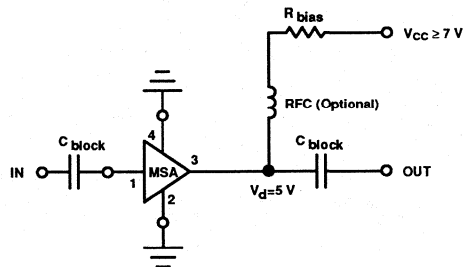

Electrical Specifications¹, $T_A = 25^\circ C$

Symbol	Parameters and Test Conditions: $I_d = 25 \text{ mA}, Z_0 = 50 \Omega$	Units	Min.	Typ.	Max.
G_p	Power Gain ($ S_{21} ^2$) $f = 0.1 \text{ GHz}$ $f = 0.5 \text{ GHz}$ $f = 1.0 \text{ GHz}$	dB	10.0	12.5 12.0 11.0	
ΔG_p	Gain Flatness $f = 0.1$ to 1.4 GHz	dB		±1.0	
$f_{3 \text{ dB}}$	3 dB Bandwidth	GHz		1.8	
VSWR	Input VSWR $f = 0.1$ to 3.0 GHz			1.3:1	
	Output VSWR $f = 0.1$ to 3.0 GHz			1.3:1	
$P_1 \text{ dB}$	Output Power @ 1 dB Gain Compression $f = 1.0 \text{ GHz}$	dBm		4.5	
NF	50 Ω Noise Figure $f = 1.0 \text{ GHz}$	dB		6.5	
IP_3	Third Order Intercept Point $f = 1.0 \text{ GHz}$	dBm		17.0	
t_D	Group Delay $f = 1.0 \text{ GHz}$	psec		150	
V_d	Device Voltage	V	4.5	5.0	5.5
dV/dT	Device Voltage Temperature Coefficient	mV/°C		-8.0	

Note: 1. The recommended operating current range for this device is 18 mA to 40 mA. Typical performance as a function of current is on the following page.

M5A-0204 MODAMP™ Cascadable Silicon Bipolar Monolithic Microwave Integrated Circuit Amplifiers

Absolute Maximum Ratings

Parameter	Absolute Maximum ¹
Device Current	60 mA
Power Dissipation ^{2,3}	325 mW
RF Input Power	+20 dBm
Junction Temperature	150°C
Storage Temperature	-65°C to 150°C

Thermal Resistance^{2,4}: $\theta_{jC} = 90^\circ\text{C/W}$

Notes:

- Permanent damage may occur if any of these limits are exceeded.
- $T_{\text{CASE}} = 25^\circ\text{C}$
- Derate at 11.1 mW/°C for $T_C > 121^\circ\text{C}$.
- See MEASUREMENTS section "Thermal Resistance" for more information.

Typical Performance, $T_A = 25^\circ\text{C}$

(unless otherwise noted)

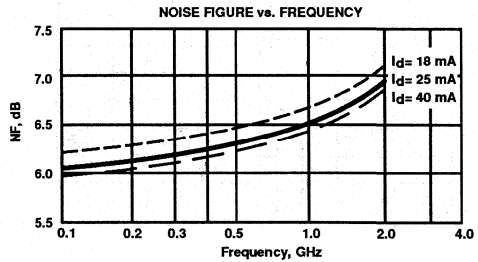
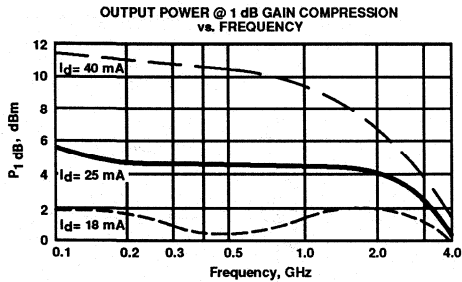
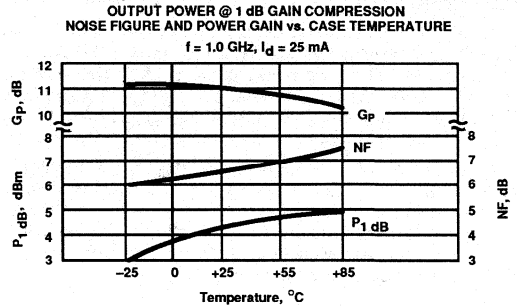
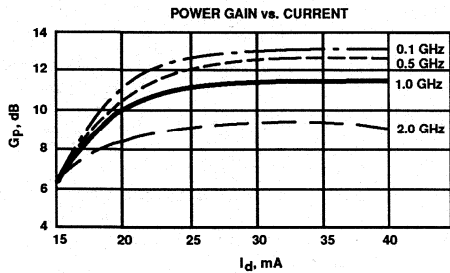
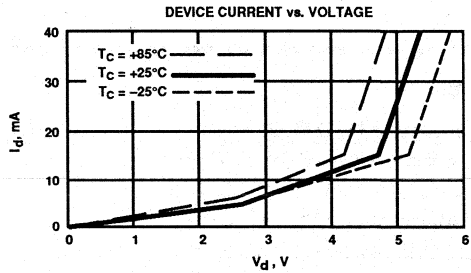

Typical Scattering Parameters: $Z_0 = 50 \Omega$

$T_A = 25^\circ\text{C}, I_d = 25 \text{ mA}$

Freq. GHz	S_{11}		S_{21}		S_{12}			S_{22}		
	Mag	Ang	dB	Mag	dB	Mag	Ang	Mag	Ang	
0.1	.12	170	12.5	4.20	174	-18.5	.119	2	.12	-7
0.2	.12	160	12.4	4.16	168	-18.5	.119	4	.12	-14
0.4	.11	140	12.2	4.05	156	-18.1	.124	6	.12	-29
0.6	.11	121	11.9	3.93	144	-17.9	.127	8	.12	-42
0.8	.10	104	11.6	3.78	134	-17.6	.132	12	.12	-52
1.0	.10	84	11.2	3.62	123	-17.0	.142	14	.13	-61
1.5	.09	42	10.2	3.22	99	-16.1	.157	16	.12	-79
2.0	.07	16	9.1	2.86	77	-14.8	.181	15	.11	-96
2.5	.05	17	8.2	2.57	63	-13.9	.202	16	.09	-115
3.0	.02	95	7.3	2.32	46	-13.2	.220	13	.08	-141
3.5	.08	112	6.5	2.12	29	-12.4	.239	7	.09	-167
4.0	.14	100	5.7	1.93	12	-11.8	.258	0	.11	171
5.0	.35	72	4.0	1.58	-22	-11.2	.276	-15	.17	120
6.0	.59	51	1.6	1.20	-54	-11.3	.272	-33	.32	80

A model for this device is available in the DEVICE MODELS section.

Features

- Cascadable 50 Ω Gain Block
- 3 dB Bandwidth: DC to 2.7 GHz
- 12.0 dB typical Gain at 1.0 GHz
- Unconditionally Stable ($k > 1$)
- Cost Effective Ceramic Microstrip Package

Description

Avantek's MSA-0235 is a high performance silicon bipolar Monolithic Microwave Integrated Circuit (MMIC) housed in a cost effective, microstrip package. This MODAMP™ MMIC is designed for use as a general purpose 50 Ω gain block. Typical applications include narrow and broad band IF and RF amplifiers in industrial and military applications.

The MODAMP MSA-series is fabricated using a 10 GHz f_T , 25 GHz f_{MAX} silicon bipolar MMIC process which utilizes nitride self-alignment, ion implantation and gold metallization to achieve excellent uniformity, performance, and reliability. The use of an external bias resistor for temperature and current stability also allows bias flexibility.

Avantek 35 micro-X Package¹

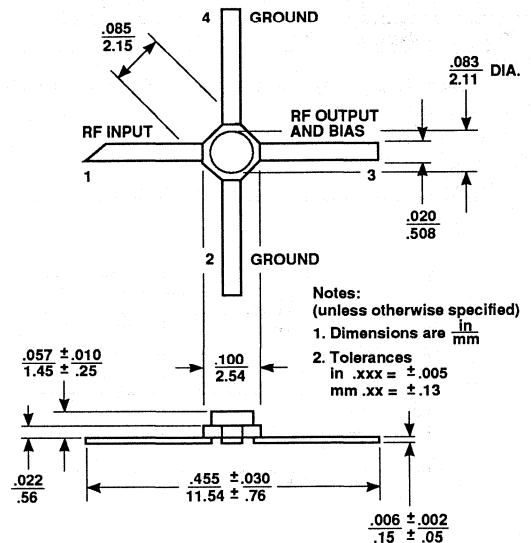

TYPICAL POWER GAIN vs. FREQUENCY
 $T_A = 25^\circ\text{C}$, $I_d = 25\text{ mA}$

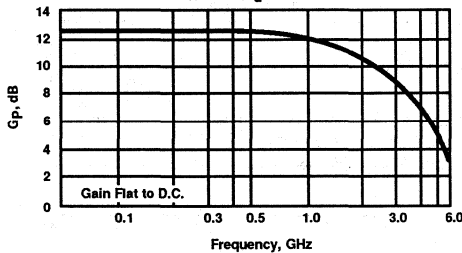

Typical Biasing Configuration

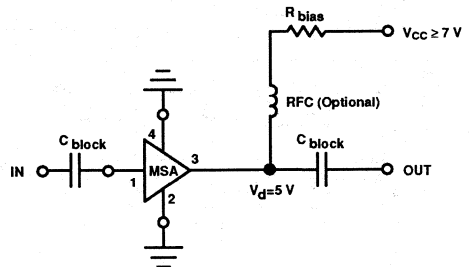

Electrical Specifications², $T_A = 25^\circ\text{C}$

Symbol	Parameters and Test Conditions: $I_d = 25\text{ mA}$, $Z_0 = 50\ \Omega$	Units	Min.	Typ.	Max.	
G_P	Power Gain ($ S_{21} ^2$)	$f = 0.1\text{ GHz}$	dB	11.5	12.5	13.5
ΔG_P	Gain Flatness	$f = 0.1\text{ to }1.6\text{ GHz}$	dB		± 0.6	± 1.0
$f_3\text{ dB}$	3 dB Bandwidth		GHz	2.7		
VSWR	Input VSWR	$f = 0.1\text{ to }3.0\text{ GHz}$		1.2:1		
	Output VSWR	$f = 0.1\text{ to }3.0\text{ GHz}$		1.4:1		
$P_{1\text{ dB}}$	Output Power @ 1 dB Gain Compression	$f = 1.0\text{ GHz}$	dBm	4.5		
NF	50 Ω Noise Figure	$f = 1.0\text{ GHz}$	dB	6.5		
IP ₃	Third Order Intercept Point	$f = 1.0\text{ GHz}$	dBm	17.0		
t_D	Group Delay	$f = 1.0\text{ GHz}$	psec.	125		
V_d	Device Voltage		V	4.5	5.0	5.5
dV/dT	Device Voltage Temperature Coefficient		mV/°C	-8.0		

Notes: 1. Short leaded 36 package available upon request.

2. The recommended operating current range for this device is 18 mA to 40 mA. Typical performance as a function of current is on the following page.

MSA-0235 MODAMP™ Cascadable Silicon Bipolar Monolithic Microwave Integrated Circuit Amplifiers

Absolute Maximum Ratings

Parameter	Absolute Maximum ¹
Device Current	60 mA
Power Dissipation ^{2,3}	325 mW
RF Input Power	+20 dBm
Junction Temperature	200°C
Storage Temperature ⁴	-65°C to 200°C

Thermal Resistance^{2,5}: $\theta_{jc} = 145^\circ\text{C/W}$

Notes:

- Permanent damage may occur if any of these limits are exceeded.
- $T_{CASE} = 25^\circ\text{C}$
- Derate at $6.9 \text{ mW}/^\circ\text{C}$ for $T_C > 153^\circ\text{C}$.
- Storage above $+150^\circ\text{C}$ may tarnish the leads of this package making it difficult to solder into a circuit.
- The small spot size of this technique results in a higher, though more accurate determination of θ_{jc} than do alternate methods. See MEASUREMENTS section "Thermal Resistance" for more information.

Typical Performance, $T_A = 25^\circ\text{C}$

(unless otherwise noted)

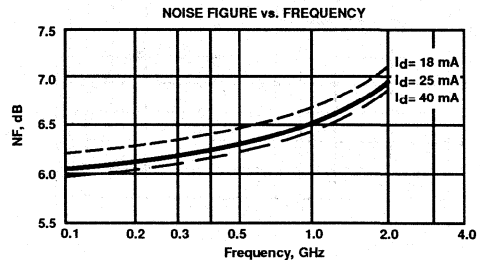
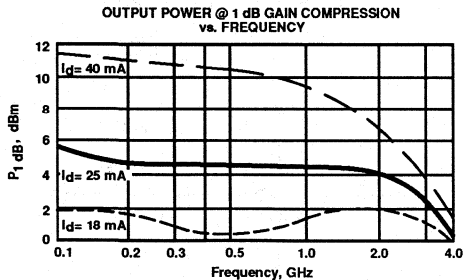
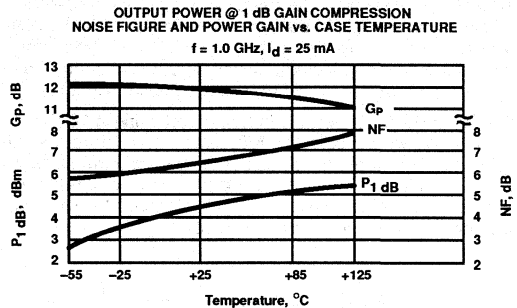
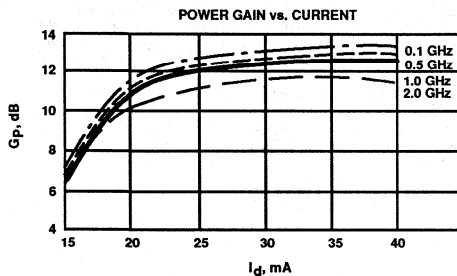
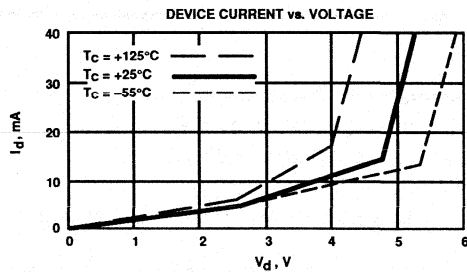

Typical Scattering Parameters: $Z_0 = 50 \Omega$

$T_A = 25^\circ\text{C}, I_d = 25 \text{ mA}$

Freq. GHz	S_{11}		S_{21}			S_{12}			S_{22}	
	Mag	Ang	dB	Mag	Ang	dB	Mag	Ang	Mag	Ang
0.1	.08	170	12.6	4.25	176	-18.6	.118	2	.16	-6
0.2	.08	163	12.5	4.23	171	-18.5	.119	2	.15	-10
0.4	.08	147	12.5	4.19	161	-18.4	.120	4	.15	-21
0.6	.08	130	12.4	4.14	152	-18.3	.121	4	.15	-30
0.8	.07	112	12.2	4.09	143	-18.1	.125	7	.15	-39
1.0	.07	91	12.1	4.02	134	-18.0	.126	10	.15	-46
1.5	.06	47	11.6	3.80	112	-17.3	.137	11	.13	-66
2.0	.03	-1	11.0	3.53	91	-16.3	.153	10	.11	-89
2.5	.03	-115	10.2	3.24	75	-15.4	.169	12	.09	-111
3.0	.09	-157	9.3	2.92	57	-15.1	.176	8	.08	-127
3.5	.16	-175	8.3	2.60	39	-14.4	.190	3	.09	-129
4.0	.20	173	7.2	2.29	23	-14.1	.198	-2	.11	-118
5.0	.27	136	5.2	1.81	-6	-13.5	.211	-11	.15	-117
6.0	.41	94	3.2	1.44	-33	-13.5	.212	-24	.11	-148

A model for this device is available in the DEVICE MODELS section.

Features

- Cascadable 50 Ω Gain Block
- 3 dB Bandwidth: DC to 2.8 GHz
- 12.0 dB typical Gain at 1.0 GHz
- Unconditionally Stable ($k > 1$)
- Hermetic Gold-ceramic Microstrip Package

Description

Avantek's MSA-0270 is a high performance silicon bipolar Monolithic Microwave Integrated Circuit (MMIC) housed in a hermetic, high reliability package. This MODAMP™ MMIC is designed for use as a general purpose 50 Ω gain block. Typical applications include narrow and broad band IF and RF amplifiers in industrial and military applications.

The MODAMP MSA-series is fabricated using a 10 GHz f_T , 25 GHz f_{MAX} silicon bipolar MMIC process which utilizes nitride self-alignment, ion implantation and gold metallization to achieve excellent uniformity, performance, and reliability. The use of an external bias resistor for temperature and current stability also allows bias flexibility.

TYPICAL POWER GAIN vs. FREQUENCY
 $T_A = 25^\circ\text{C}, I_d = 25\text{ mA}$

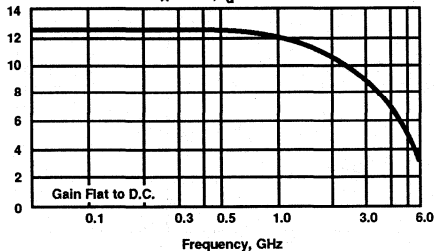

Avantek 70 mil Package

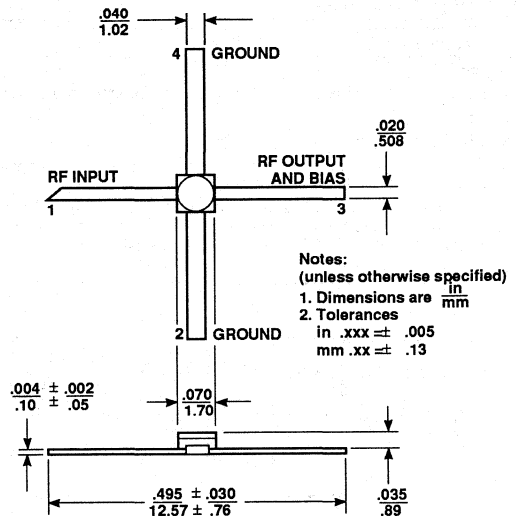

Typical Biasing Configuration

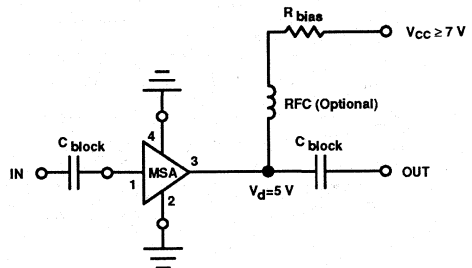

Electrical Specifications¹, $T_A = 25^\circ\text{C}$

Symbol	Parameters and Test Conditions: $I_d = 25\text{ mA}, Z_0 = 50\ \Omega$	Units	Min.	Typ.	Max.
G_p	Power Gain ($ S_{21} ^2$) $f = 0.1\text{ GHz}$	dB	11.5	12.5	13.5
ΔG_p	Gain Flatness $f = 0.1\text{ to }1.8\text{ GHz}$	dB		± 0.6	± 1.0
$f_{3\text{ dB}}$	3 dB Bandwidth	GHz		2.8	
VSWR	Input VSWR $f = 0.1\text{ to }3.0\text{ GHz}$			1.4:1	
	Output VSWR $f = 0.1\text{ to }3.0\text{ GHz}$			1.4:1	
$P_1\text{ dB}$	Output Power @ 1 dB Gain Compression $f = 1.0\text{ GHz}$	dBm		4.5	
NF	50 Ω Noise Figure $f = 1.0\text{ GHz}$	dB		6.5	
IP_3	Third Order Intercept Point $f = 1.0\text{ GHz}$	dBm		17.0	
t_D	Group Delay $f = 1.0\text{ GHz}$	psec.		125	
V_d	Device Voltage	V	4.5	5.0	5.5
dV/dT	Device Voltage Temperature Coefficient	$\text{mV}/^\circ\text{C}$		-8.0	

Note: 1. The recommended operating current range for this device is 18 mA to 40 mA. Typical performance as a function of current is on the following page.

MSA-0270 MODAMP™ Cascadable Silicon Bipolar Monolithic Microwave Integrated Circuit Amplifiers

Absolute Maximum Ratings

Parameter	Absolute Maximum ¹
Device Current	60 mA
Power Dissipation ^{2,3}	325 mW
RF Input Power	+20 dBm
Junction Temperature	200°C
Storage Temperature	-65°C to 200°C

Thermal Resistance^{2,4}: $\theta_{jC} = 120^\circ\text{C/W}$

Notes:

- Permanent damage may occur if any of these limits are exceeded.
- TCASE = 25°C
- Derate at 8.3 mW/°C for $T_C > 161^\circ\text{C}$.
- The small spot size of this technique results in a higher, though more accurate determination of θ_{jC} than do alternate methods. See MEASUREMENTS section "Thermal Resistance" for more information.

Typical Performance, $T_A = 25^\circ\text{C}$

(unless otherwise noted)

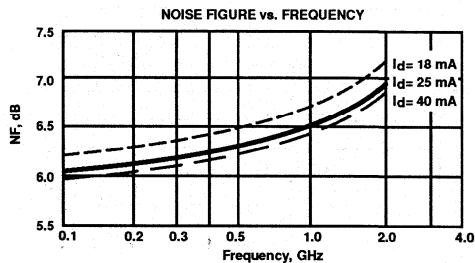
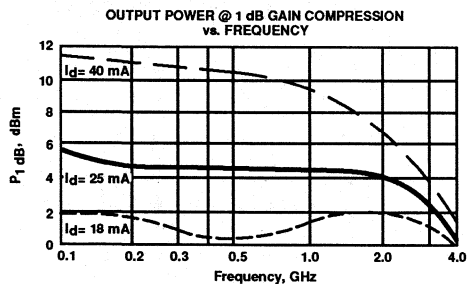
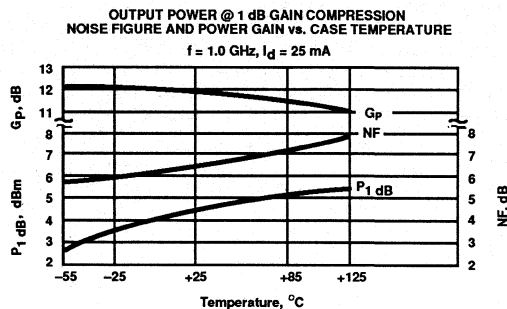
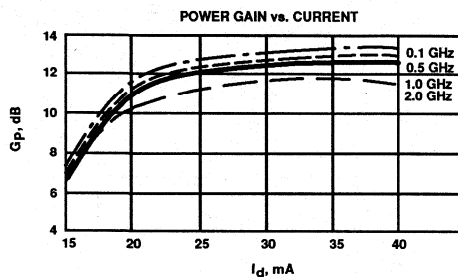
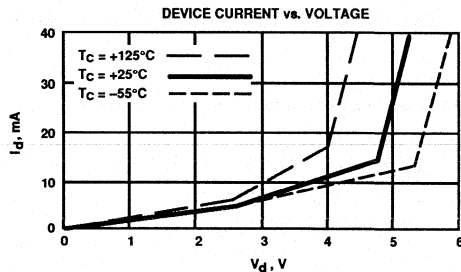

Typical Scattering Parameters: $Z_0 = 50 \Omega$

$T_A = 25^\circ\text{C}, I_d = 25 \text{ mA}$

Freq. GHz	S_{11}		S_{21}			S_{12}			S_{22}	
	Mag	Ang	dB	Mag	Ang	dB	Mag	Ang	Mag	Ang
0.1	.11	179	12.6	4.26	176	-18.4	.120	1	.12	-8
0.2	.11	174	12.6	4.24	171	-18.6	.117	3	.12	-15
0.4	.10	169	12.5	4.21	162	-18.4	.120	4	.13	-30
0.6	.09	165	12.4	4.17	154	-18.2	.123	5	.14	-44
0.8	.08	161	12.3	4.11	146	-18.2	.123	7	.14	-55
1.0	.06	161	12.2	4.05	137	-18.0	.126	9	.15	-64
1.5	.02	-150	11.7	3.85	116	-17.2	.138	11	.16	-84
2.0	.06	-110	11.1	3.57	96	-16.3	.153	11	.16	-102
2.5	.11	-112	10.3	3.27	82	-15.7	.165	14	.14	-106
3.0	.17	-134	9.3	2.92	65	-15.2	.174	12	.13	-114
3.5	.22	-147	8.2	2.56	48	-14.7	.185	6	.15	-111
4.0	.26	-156	7.0	2.23	33	-14.3	.192	3	.19	-107
5.0	.28	-179	4.7	1.72	8	-14.0	.199	-6	.27	-107
6.0	.30	143	3.0	1.41	-13	-13.8	.204	-14	.29	-119

A model for this device is available in the DEVICE MODELS section.

Features

- Cascadable 50 Ω Gain Block
- 3 dB Bandwidth: DC to 2.6 GHz
- 12.0 dB typical Gain at 1.0 GHz
- Unconditionally Stable ($k > 1$)
- Low Cost Plastic Package

Description

Avantek's MSA-0285 is a high performance silicon bipolar Monolithic Microwave Integrated Circuit (MMIC) housed in a low cost plastic package. This MODAMP™ MMIC is designed for use as a general purpose 50 Ω gain block. Typical applications include narrow and broad band IF and RF amplifiers in industrial and military applications.

The MODAMP MSA-series is fabricated using a 10 GHz f_t , 25 GHz f_{MAX} silicon bipolar MMIC process which utilizes nitride self-alignment, ion implantation and gold metallization to achieve excellent uniformity, performance, and reliability. The use of an external bias resistor for temperature and current stability also allows bias flexibility.

Avantek 85 Plastic Package

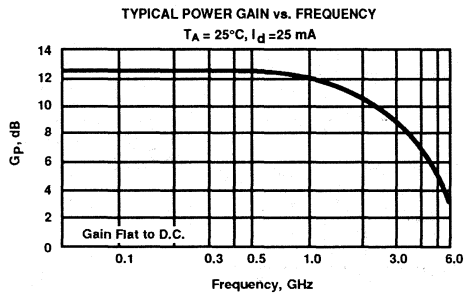
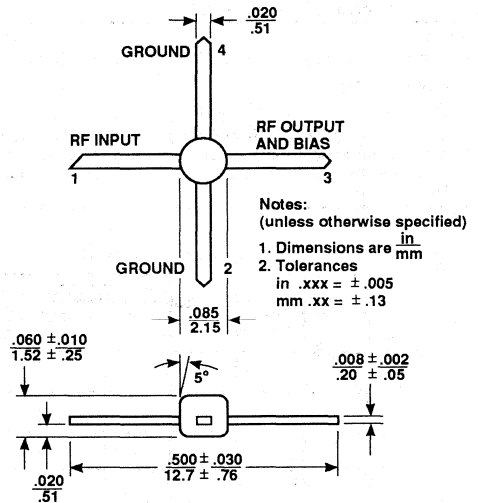

Typical Biasing Configuration

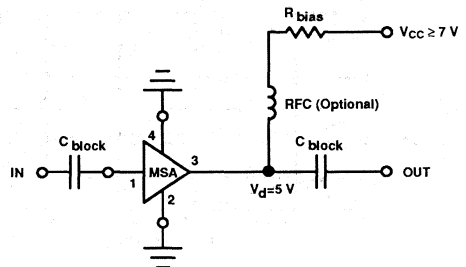

Electrical Specifications¹, $T_A = 25^\circ C$

Symbol	Parameters and Test Conditions: $I_d = 25 \text{ mA}, Z_0 = 50 \Omega$	Units	Min.	Typ.	Max.
G_P	Power Gain ($ S_{21} ^2$) $f = 0.1 \text{ GHz}$ $f = 1.0 \text{ GHz}$	dB	10.0	12.5 12.0	
ΔG_P	Gain Flatness $f = 0.1 \text{ to } 1.6 \text{ GHz}$	dB		± 0.6	
$f_{3 \text{ dB}}$	3 dB Bandwidth	GHz		2.6	
VSWR	Input VSWR $f = 0.1 \text{ to } 3.0 \text{ GHz}$			1.3:1	
	Output VSWR $f = 0.1 \text{ to } 3.0 \text{ GHz}$			1.4:1	
$P_{1 \text{ dB}}$	Output Power @ 1 dB Gain Compression $f = 1.0 \text{ GHz}$	dBm		4.5	
NF	50 Ω Noise Figure $f = 1.0 \text{ GHz}$	dB		6.5	
IP_3	Third Order Intercept Point $f = 1.0 \text{ GHz}$	dBm		17.0	
t_D	Group Delay $f = 1.0 \text{ GHz}$	psec.		125	
V_d	Device Voltage	V	4.0	5.0	6.0
dV/dT	Device Voltage Temperature Coefficient	mV/°C		-8.0	

Note: 1. The recommended operating current range for this device is 18 mA to 40 mA. Typical performance as a function of current is on the following page.

MSA-0285 MODAMP™ Cascadable Silicon Bipolar Monolithic Microwave Integrated Circuit Amplifiers

Absolute Maximum Ratings

Parameter	Absolute Maximum ¹
Device Current	60 mA
Power Dissipation ^{2,3}	325 mW
RF Input Power	+20 dBm
Junction Temperature	150°C
Storage Temperature	-65°C to 150°C

Thermal Resistance^{2,4}: $\theta_{jC} = 95^\circ\text{C/W}$

Notes:

- Permanent damage may occur if any of these limits are exceeded.
- $T_{CASE} = 25^\circ\text{C}$
- Derate at 10.5 mW/°C for $T_C > 119^\circ\text{C}$.
- See MEASUREMENTS section "Thermal Resistance" for more information.

Typical Performance, $T_A = 25^\circ\text{C}$

(unless otherwise noted)

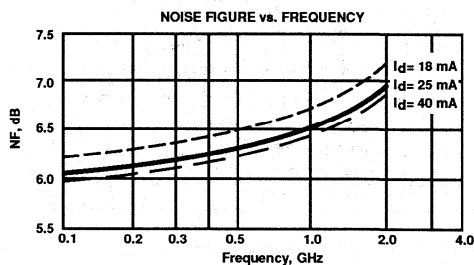
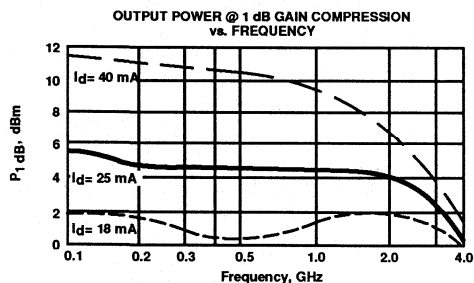
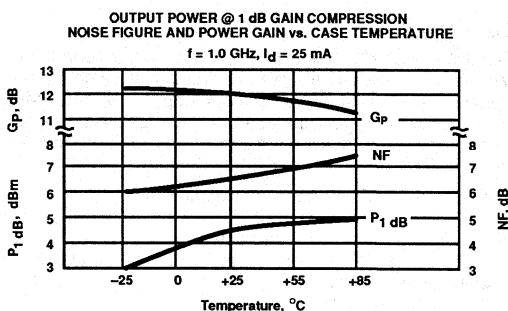
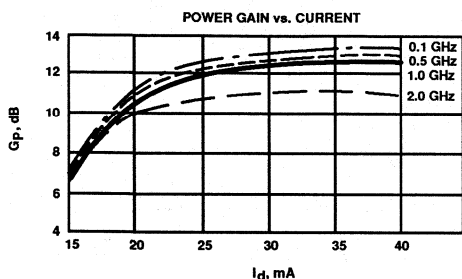
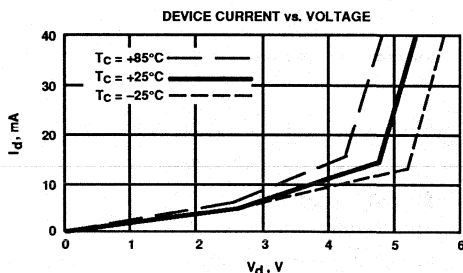

Typical Scattering Parameters: $Z_0 = 50 \Omega$

$T_A = 25^\circ\text{C}, I_d = 25 \text{ mA}$

Freq. GHz	S_{11}		S_{21}			S_{12}			S_{22}	
	Mag	Ang	dB	Mag	Ang	dB	Mag	Ang	Mag	Ang
0.1	.10	174	12.6	4.25	175	-18.6	.118	2	.14	-7
0.2	.10	168	12.5	4.22	171	-18.5	.119	3	.13	-12
0.4	.10	157	12.4	4.17	161	-18.3	.122	6	.14	-26
0.6	.09	143	12.3	4.10	153	-18.3	.121	7	.14	-38
0.8	.08	132	12.1	4.03	144	-18.0	.126	11	.14	-48
1.0	.08	122	11.9	3.95	135	-17.5	.133	12	.14	-60
1.5	.04	95	11.4	3.70	115	-17.0	.142	16	.13	-85
2.0	.02	117	10.6	3.40	95	-16.0	.158	17	.12	-110
2.5	.05	-173	9.9	3.11	82	-15.0	.177	20	.12	-128
3.0	.12	-175	8.9	2.78	65	-14.7	.185	19	.11	-148
3.5	.16	179	7.9	2.49	49	-14.0	.199	14	.10	-145
4.0	.21	169	6.9	2.22	35	-13.7	.207	11	.10	-134
5.0	.28	139	5.0	1.77	9	-13.0	.224	4	.12	-118
6.0	.41	100	3.0	1.42	-16	-12.9	.226	-5	.09	-154

A model for this device is available in the DEVICE MODELS section.

Features

- Cascadable 50 Ω Gain Block
- 3 dB Bandwidth: DC to 2.5 GHz
- 12.0 dB typical Gain at 1.0 GHz
- Unconditionally Stable ($k > 1$)
- Surface Mount Plastic Package
- Tape-and-Reel Packaging Option Available¹

Description

Avantek's MSA-0286 is a high performance silicon bipolar Monolithic Microwave Integrated Circuit (MMIC) housed in a low cost, surface mount plastic package. This MODAMP™ MMIC is designed for use as a general purpose 50 Ω gain block. Applications include narrow and broad band IF and RF amplifiers in commercial and industrial applications.

The MODAMP MSA-series is fabricated using a 10 GHz f_T , 25 GHz f_{MAX} silicon bipolar MMIC process which utilizes nitride self-alignment, ion implantation and gold metallization to achieve excellent uniformity, performance, and reliability. The use of an external bias resistor for temperature and current stability also allows bias flexibility.

Avantek 86 Plastic Package

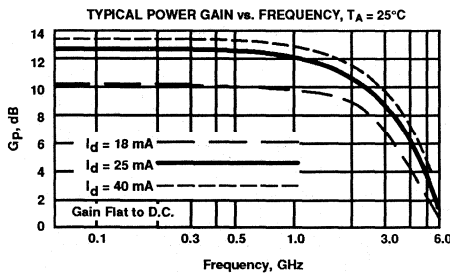
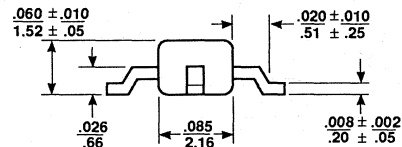
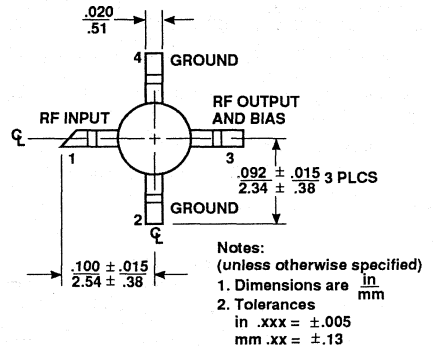

Typical Biasing Configuration

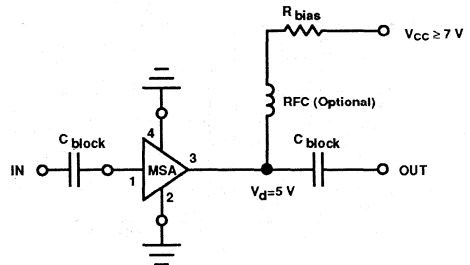

Electrical Specifications², $T_A = 25^\circ\text{C}$

Symbol	Parameters and Test Conditions: $I_d = 25\text{ mA}$, $Z_0 = 50\ \Omega$	Units	Min.	Typ.	Max.
Gp	Power Gain ($ S_{21} ^2$) $f = 0.1\text{ GHz}$ $f = 1.0\text{ GHz}$	dB	10.0	12.5 12.0	
ΔG_p	Gain Flatness $f = 0.1\text{ to }1.6\text{ GHz}$	dB		±0.6	
$f_{3\text{ dB}}$	3 dB Bandwidth	GHz		2.5	
VSWR	Input VSWR $f = 0.1\text{ to }3.0\text{ GHz}$			1.5:1	
	Output VSWR $f = 0.1\text{ to }3.0\text{ GHz}$			1.4:1	
P_1 dB	Output Power @ 1 dB Gain Compression $f = 1.0\text{ GHz}$	dBm		4.5	
NF	50 Ω Noise Figure $f = 1.0\text{ GHz}$	dB		6.5	
IP ₃	Third Order Intercept Point $f = 1.0\text{ GHz}$	dBm		17.0	
t _D	Group Delay $f = 1.0\text{ GHz}$	psec.		140	
V_d	Device Voltage	V	4.0	5.0	6.0
dV/dT	Device Voltage Temperature Coefficient	mV/°C		-8.0	

Notes: 1. Refer to PACKAGING section "Tape-and-Reel Packaging for Surface Mount Semiconductors".
 2. The recommended operating current range for this device is 18 mA to 40 mA. Typical performance as a function of current is on the following page.

MSA-0286 MODAMP™ Cascadable Silicon Bipolar Monolithic Microwave Integrated Circuit Amplifiers

Absolute Maximum Ratings

Parameter	Absolute Maximum ¹
Device Current	60 mA
Power Dissipation ^{2,3}	325 mW
RF Input Power	+20 dBm
Junction Temperature	150°C
Storage Temperature	-65°C to 150°C

Thermal Resistance^{2,4}: $\theta_{jC} = 105^\circ\text{C/W}$

Notes:

1. Permanent damage may occur if any of these limits are exceeded.
2. $T_{CASE} = 25^\circ\text{C}$
3. Derate at 9.5 mW/°C for $T_C > 116^\circ\text{C}$.
4. See MEASUREMENTS section "Thermal Resistance" for more information.

Part Number Ordering Information

Part Number	Devices Per Reel	Reel Size
MSA-0286-TR1	1000	7"
MSA-0286-TR2	4000	13"

Typical Performance, $T_A = 25^\circ\text{C}$

(unless otherwise noted)

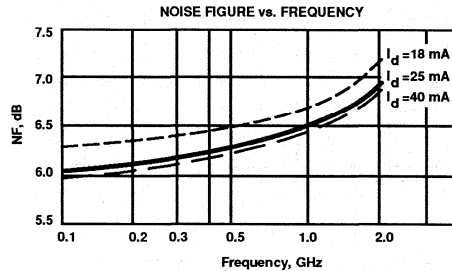
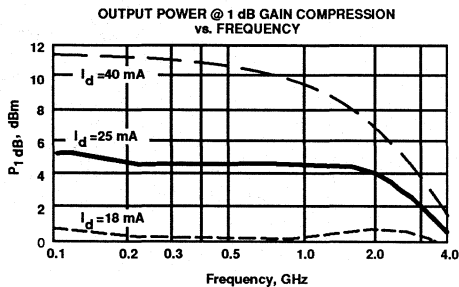
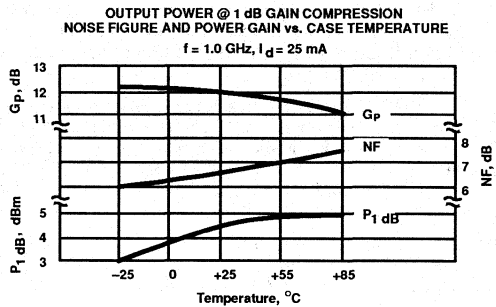
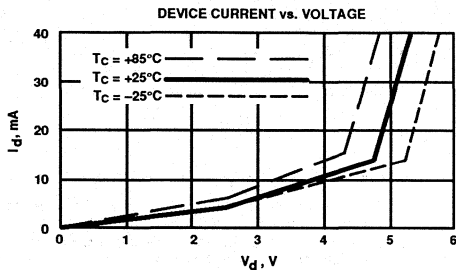

Typical Scattering Parameters: $Z_0 = 50 \Omega$

$T_A = 25^\circ\text{C}, I_d = 25 \text{ mA}$

Freq. GHz	S_{11}			S_{21}			S_{12}			S_{22}		
	Mag	Ang	dB	Mag	Ang	dB	Mag	Ang	Mag	Ang	dB	
0.1	.10	171	12.5	4.22	175	-18.5	.119	1	.16	-5		
0.2	.10	161	12.5	4.20	170	-18.3	.121	3	.16	-11		
0.4	.10	144	12.4	4.16	159	-18.2	.122	6	.15	-24		
0.6	.09	129	12.2	4.09	149	-18.0	.126	6	.15	-36		
0.8	.08	119	12.1	4.01	139	-18.0	.127	9	.14	-48		
1.0	.08	108	11.9	3.91	129	-17.4	.135	8	.14	-62		
1.5	.06	111	11.3	3.67	106	-16.5	.149	12	.11	-99		
2.0	.08	141	10.5	3.35	84	-15.7	.164	11	.11	-141		
2.5	.14	150	9.6	3.01	67	-14.8	.182	9	.12	-176		
3.0	.21	142	8.6	2.68	48	-14.3	.194	5	.13	155		
3.5	.29	132	7.5	2.37	30	-14.0	.200	1	.14	140		
4.0	.36	121	6.4	2.09	15	-13.5	.211	-3	.16	134		
5.0	.50	101	4.1	1.61	-12	-13.3	.216	-12	.20	132		

A model for this device is available in the DEVICE MODELS section.

Features

- **Cascadable 50 Ω Gain Block**
- **3 dB Bandwidth: DC to 2.8 GHz**
- **12.0 dB typical Gain at 1.0 GHz**
- **10.0 dBm typical P_{1 dB} at 1.0 GHz**

Description

Avantek's MSA-0300 is a high performance silicon bipolar Monolithic Microwave Integrated Circuit (MMIC) chip. This MODAMP™ MMIC is designed for use as a general purpose 50 Ω gain block. Typical applications include narrow and broad band IF and RF amplifiers in commercial, industrial and military applications.

The MODAMP MSA-series is fabricated using a 10 GHz f_r, 25 GHz f_{MAX} silicon bipolar MMIC process which utilizes nitride self-alignment, ion implantation and gold metallization to achieve excellent uniformity, performance, and reliability. The use of an external bias resistor for temperature and current stability also allows bias flexibility.

The recommended assembly procedure is gold-eutectic die attach at 400°C and either wedge or ball bonding using 0.7 mil gold wire. See APPLICATIONS section, "Chip Use".

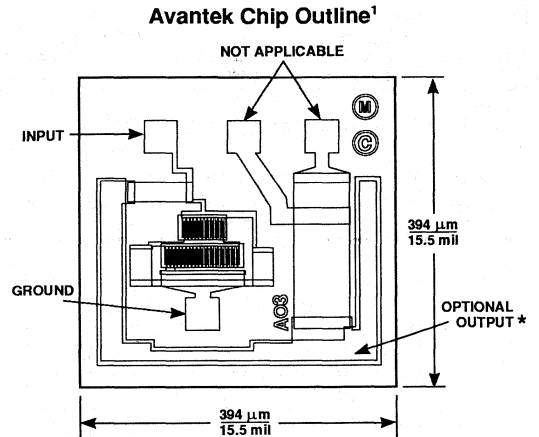

Unless otherwise specified, tolerances are ±13 μm / ±0.5 mils.
 Chip thickness is 114 μm / 4.5 mil. Bond pads are 41 μm / 1.6 mil typical on each side.
 * Output contact is made by die attaching the backside of the die.

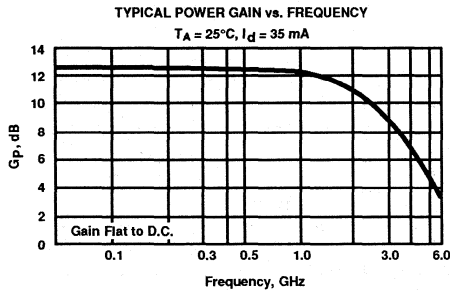

Typical Biasing Configuration

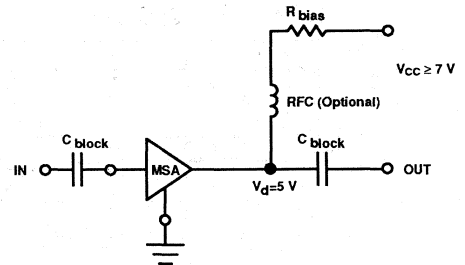

Electrical Specifications², T_A = 25°C

Symbol	Parameters and Test Conditions ³ : I _d = 35 mA, Z ₀ = 50 Ω	Units	Min.	Typ.	Max.
GP	Power Gain (S ₂₁ ²)	f = 0.1 GHz		12.5	
ΔGP	Gain Flatness	f = 0.1 to 1.8 GHz		±0.6	
f _{3 dB}	3 dB Bandwidth			2.8	
VSWR	Input VSWR	f = 0.1 to 3.0 GHz		1.8:1	
	Output VSWR	f = 0.1 to 3.0 GHz		1.8:1	
P _{1 dB}	Output Power @ 1 dB Gain Compression	f = 1.0 GHz		10.0	
NF	50 Ω Noise Figure	f = 1.0 GHz		6.0	
IP ₃	Third Order Intercept Point	f = 1.0 GHz		23.0	
t _D	Group Delay	f = 1.0 GHz		125	
V _d	Device Voltage		4.5	5.0	5.5
dV/dT	Device Voltage Temperature Coefficient			-8.0	

Notes: 1. This chip contains additional biasing options. The performance specified applies only to the bias option whose bond pads are indicated on the chip outline. Refer to the APPLICATIONS section "MODAMP™ Silicon MMIC Chip Use" for additional information.
 2. The recommended operating current range for this device is 20 mA to 50 mA. Typical performance as a function of current is on the following page.
 3. RF performance of the chip is determined by packaging and testing 10 devices per wafer in a dual ground configuration.

MSA-0300 MODAMP™ Cascadable Silicon Bipolar Monolithic Microwave Integrated Circuit Amplifiers

Absolute Maximum Ratings

Parameter	Absolute Maximum ¹
Device Current	80 mA
Power Dissipation ^{2,3}	425 mW
RF Input Power	+20 dBm
Junction Temperature	200°C
Storage Temperature	-65°C to 200°C
Thermal Resistance ^{2,4} : $\theta_{jc} = 45^\circ\text{C}/\text{W}$	

Notes:

1. Permanent damage may occur if any of these limits are exceeded.
2. TCASE = 25°C
3. Derate at 22.2 mW/°C for TC > 181°C.
4. The small spot size of this technique results in a higher, though more accurate determination of θ_{jc} than do alternate methods. See MEASUREMENTS section "Thermal Resistance" for more information.

Part Number Ordering Information

Part Number	Devices Per Tray
MSA-0300-GP2	10
MSA-0300-GP4	100
MSA-0300-GP6	up to 300

Typical Performance, T_A = 25°C

(unless otherwise noted)

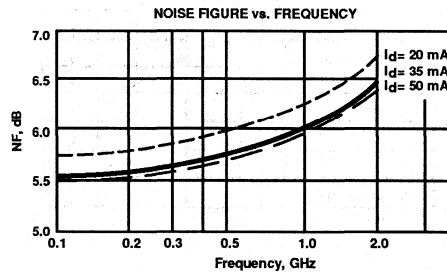
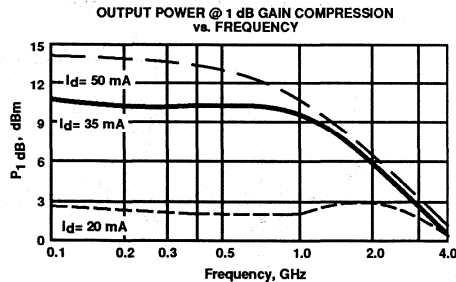
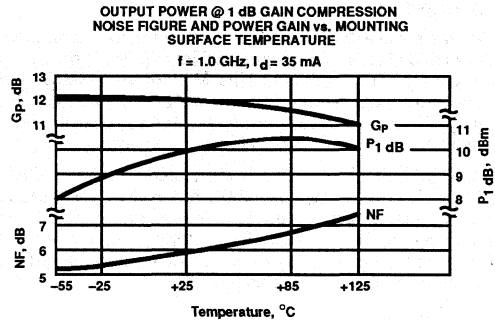
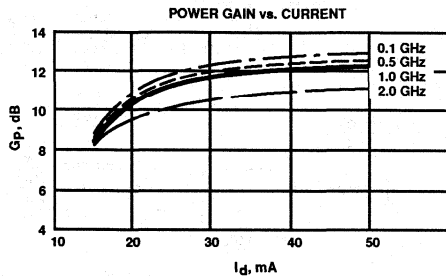

Typical Scattering Parameters⁴: Z_O = 50 Ω

T_A = 25°C, I_d = 35 mA

Freq. GHz	S ₁₁		S ₂₁			S ₁₂			S ₂₂		k
	Mag	Ang	dB	Mag	Ang	dB	Mag	Ang	Mag	Ang	
0.1	.13	-179	12.6	4.28	177	-18.6	.118	2	.09	-13	1.21
0.2	.13	-179	12.6	4.27	172	-18.3	.121	3	.10	-27	1.19
0.4	.12	-179	12.5	4.24	165	-18.3	.121	5	.12	-48	1.19
0.6	.11	-177	12.5	4.22	158	-18.2	.123	8	.14	-65	1.18
0.8	.11	-172	12.4	4.19	152	-17.8	.129	11	.17	-76	1.15
1.0	.10	-166	12.4	4.15	144	-17.7	.130	12	.20	-85	1.14
1.5	.11	-145	12.0	4.00	126	-17.1	.139	17	.24	-104	1.09
2.0	.16	-140	11.5	3.76	109	-16.2	.154	20	.27	-122	1.03
2.5	.23	-141	10.8	3.47	97	-15.6	.166	25	.28	-133	0.99
3.0	.29	-149	9.8	3.10	82	-15.2	.173	24	.28	-145	0.99
3.5	.35	-157	8.7	2.72	67	-14.5	.188	22	.27	-148	0.97
4.0	.38	-164	7.6	2.40	55	-14.3	.193	21	.25	-146	1.00
5.0	.41	179	5.5	1.88	35	-13.7	.206	17	.21	-134	1.14
6.0	.43	153	3.6	1.51	18	-13.3	.217	14	.21	-137	1.27

Note: 4. S-parameters are de-embedded from 70 mil package measured data using the package model found in the DEVICE MODELS section.

Features

- Cascadable 50 Ω Gain Block
- 3 dB Bandwidth: DC to 1.6 GHz
- 11.0 dB typical Gain at 1.0 GHz
- 10.0 dBm typical P_{1 dB} at 1.0 GHz
- Unconditionally Stable (k>1)
- Low Cost Plastic Package

Description

Avantek's MSA-0304 is a high performance silicon bipolar Monolithic Microwave Integrated Circuit (MMIC) housed in a low cost plastic package. This MODAMP™ MMIC is designed for use as a general purpose 50 Ω gain block. Typical applications include narrow and broad band IF and RF amplifiers in industrial and military applications.

The MODAMP MSA-series is fabricated using a 10 GHz f_T, 25 GHz f_{MAX} silicon bipolar MMIC process which utilizes nitride self-alignment, ion implantation and gold metallization to achieve excellent uniformity, performance, and reliability. The use of an external bias resistor for temperature and current stability also allows bias flexibility.

Avantek 04 Plastic Package

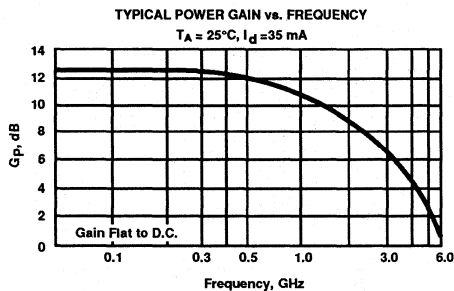
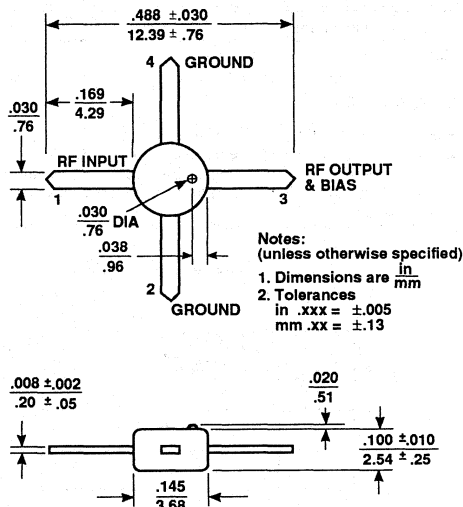

Typical Biasing Configuration

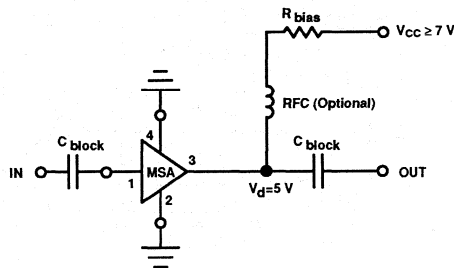

Electrical Specifications¹, TA = 25°C

Symbol	Parameters and Test Conditions: Id = 35 mA, ZO = 50 Ω	Units	Min.	Typ.	Max.
Gp	Power Gain (S21 ²) f = 0.1 GHz f = 0.5 GHz f = 1.0 GHz	dB	10.0	12.5 12.0 11.0	
ΔGp	Gain Flatness f = 0.1 to 1.3 GHz	dB		±1.0	
f3 dB	3 dB Bandwidth	GHz		1.6	
VSWR	Input VSWR f = 0.1 to 3.0 GHz			1.3:1	
	Output VSWR f = 0.1 to 3.0 GHz			1.6:1	
P1 dB	Output Power @ 1 dB Gain Compression f = 1.0 GHz	dBm		10.0	
NF	50 Ω Noise Figure f = 1.0 GHz	dB		6.0	
IP3	Third Order Intercept Point f = 1.0 GHz	dBm		23.0	
tD	Group Delay f = 1.0 GHz	psec.		150	
Vd	Device Voltage	V	4.5	5.0	5.5
dV/dT	Device Voltage Temperature Coefficient	mV/°C		-8.0	

Note: 1. The recommended operating current range for this device is 20 mA to 50 mA. Typical performance as a function of current is on the following page.

MSA-0304 MODAMP™ Cascadable Silicon Bipolar Monolithic Microwave Integrated Circuit Amplifiers

Absolute Maximum Ratings

Parameter	Absolute Maximum ¹
Device Current	70 mA
Power Dissipation ^{2,3}	400 mW
RF Input Power	+20 dBm
Junction Temperature	150°C
Storage Temperature	-65°C to 150°C

Thermal Resistance^{2,4}: $\theta_{JC} = 100^\circ\text{C}/\text{W}$

Notes:

1. Permanent damage may occur if any of these limits are exceeded.
2. $T_{CASE} = 25^\circ\text{C}$
3. Derate at 10 mW/°C for $T_C > 110^\circ\text{C}$.
4. See MEASUREMENTS section "Thermal Resistance" for more information.

Typical Performance, $T_A = 25^\circ\text{C}$

(unless otherwise noted)

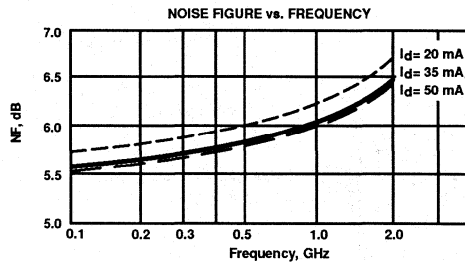
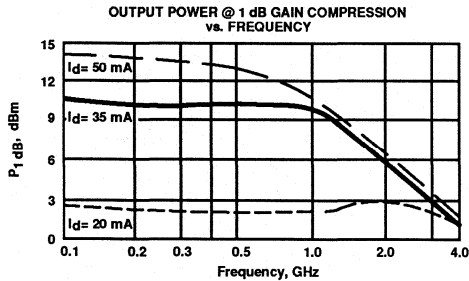
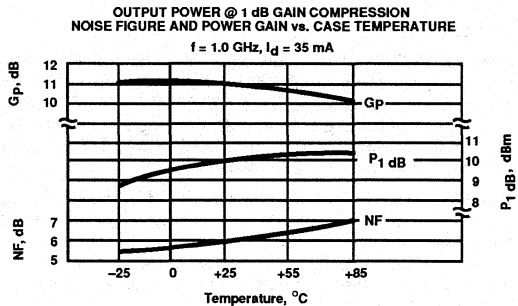
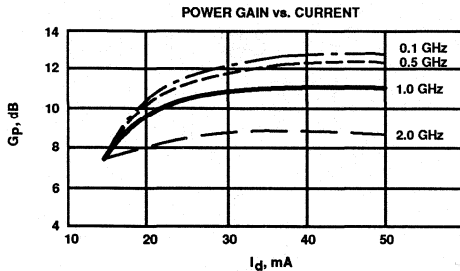
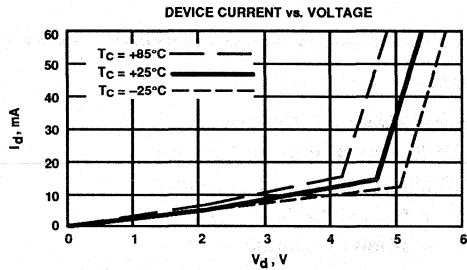

Typical Scattering Parameters: $Z_0 = 50 \Omega$

$T_A = 25^\circ\text{C}, I_d = 35 \text{ mA}$

Freq. GHz	S_{11}		S_{21}			S_{12}			S_{22}	
	Mag	Ang	dB	Mag	Ang	dB	Mag	Ang	Mag	Ang
0.1	.10	173	12.5	4.24	173	-18.5	.120	3	.12	-13
0.2	.10	162	12.5	4.21	167	-18.2	.123	4	.12	-24
0.4	.09	142	12.2	4.08	153	-18.0	.125	7	.13	-46
0.6	.08	127	11.9	3.93	141	-17.8	.128	10	.15	-64
0.8	.07	110	11.5	3.76	130	-17.3	.136	14	.16	-78
1.0	.06	92	11.1	3.58	118	-16.8	.144	16	.17	-91
1.5	.03	58	10.0	3.15	93	-15.5	.169	19	.19	-117
2.0	.03	175	8.8	2.76	71	-14.1	.197	18	.20	-139
2.5	.05	163	7.8	2.46	55	-13.2	.218	18	.21	-158
3.0	.12	148	6.8	2.20	38	-12.2	.246	15	.22	-174
3.5	.19	129	5.9	1.98	20	-11.2	.275	7	.24	171
4.0	.26	110	5.0	1.77	3	-10.6	.296	1	.26	158
5.0	.44	77	3.0	1.41	-28	-9.9	.319	-15	.29	128
6.0	.63	52	0.4	1.05	-56	-10.2	.310	-31	.37	94

A model for this device is available in the DEVICE MODELS section.

Features

- Cascadable 50 Ω Gain Block
- 3 dB Bandwidth: DC to 2.3 GHz
- 11.0 dB typical Gain at 1.0 GHz
- 9.0 dBm typical P_{1 dB} at 1.0 GHz
- Unconditionally Stable (k>1)
- Low Cost Surface Mount Plastic Package
- Tape-and-Reel Packaging Option Available¹

Description

Avantek's MSA-0311 is a low cost silicon bipolar Monolithic Microwave Integrated Circuit (MMIC) housed in the surface mount plastic SOT-143 package. This MODAMP™ MMIC is designed for use as a general purpose 50 Ω gain block. Typical applications include narrow and broad band IF and RF amplifiers in commercial and industrial applications.

The MODAMP MSA-series is fabricated using a 10 GHz f_T, 25 GHz f_{MAX} silicon bipolar MMIC process which utilizes nitride self-alignment, ion implantation and gold metallization to achieve excellent uniformity, performance, and reliability. The use of an external bias resistor for temperature and current stability also allows bias flexibility.

Typical Biasing Configuration

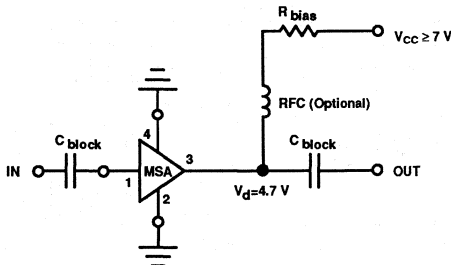

Avantek SOT-143 Package

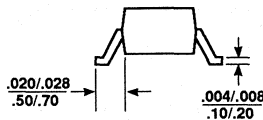
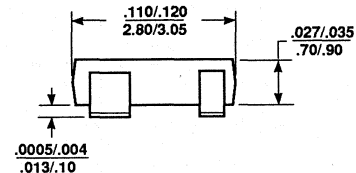
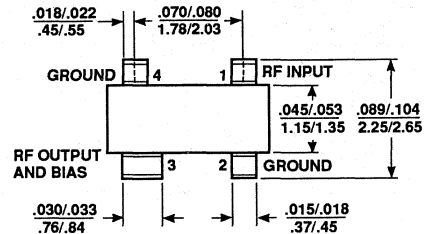

Notes:
(unless otherwise specified)

Dimensions are:
in (min/max)
mm (min/max)

Electrical Specifications², T_A = 25°C

Symbol	Parameters and Test Conditions: I _d = 35 mA, Z ₀ = 50 Ω	Units	Min.	Typ.	Max.
G _p	Power Gain (S ₂₁ ²) f = 0.1 GHz f = 1.0 GHz	dB	9.0	11.5 11.0	
ΔG _p	Gain Flatness f = 0.1 to 1.6 GHz	dB		±0.7	
f _{3 dB}	3 dB Bandwidth	GHz		2.3	
VSWR	Input VSWR f = 0.1 to 3.0 GHz			1.5:1	
	Output VSWR f = 0.1 to 3.0 GHz			1.7:1	
P _{1 dB}	Output Power @ 1 dB Gain Compression f = 1.0 GHz	dBm		9.0	
NF	50 Ω Noise Figure f = 1.0 GHz	dB		6.0	
IP ₃	Third Order Intercept Point f = 1.0 GHz	dBm		22.0	
t _D	Group Delay f = 1.0 GHz	psec.		140	
V _d	Device Voltage T _c = 25°C	V	3.8	4.7	5.6
dV/dT	Device Voltage Temperature Coefficient	mV/°C		-8.0	

Notes: 1. Refer to PACKAGING section "Tape-and-Reel Packaging for Surface Mount Semiconductors".

2. The recommended operating current range for this device is 20 mA to 40 mA. Typical gain performance as a function of current is on the following page.

MSA-0311 MODAMP™ Cascadable Silicon Bipolar Monolithic Microwave Integrated Circuit Amplifiers

Absolute Maximum Ratings

Parameter	Absolute Maximum ¹
Device Current	60 mA
Power Dissipation ^{2,3}	240 mW
RF Input Power	+20 dBm
Junction Temperature	150°C
Storage Temperature	-65°C to 150°C

Thermal Resistance^{2,4}: $\theta_{jC} = 500^\circ\text{C}/\text{W}$

Notes:

1. Permanent damage may occur if any of these limits are exceeded.
2. TCASE = 25°C
3. Derate at 2.0 mW/°C for TC > 30°C.
4. See MEASUREMENTS section "Thermal Resistance" for more information.

Part Number Ordering Information

Part Number	Devices Per Reel	Reel Size
MSA-0311-TR1	3000	7"
MSA-0311-TR2	10000	13"

Typical Performance, TA = 25°C

(unless otherwise noted)

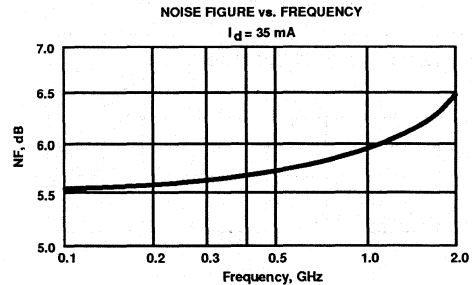
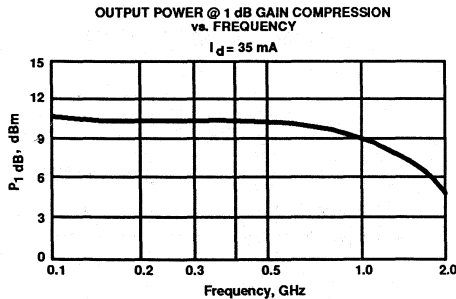
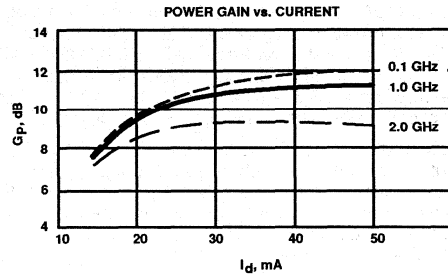
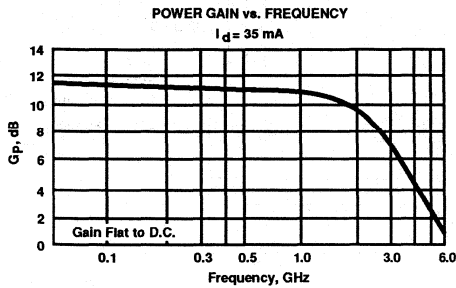

Typical Scattering Parameters: ZO = 50 Ω

TA = 25°C, Id = 35 mA

Freq. GHz	S11		S21			S12			S22	
	Mag	Ang	dB	Mag	Ang	dB	Mag	Ang	Mag	Ang
0.1	.06	25	11.7	3.84	175	-17.9	.127	2	.24	-7
0.2	.07	31	11.7	3.83	170	-17.9	.128	3	.23	-13
0.4	.07	38	11.6	3.78	159	-17.8	.129	6	.24	-28
0.6	.07	30	11.4	3.72	149	-17.6	.132	8	.24	-40
0.8	.08	21	11.2	3.65	140	-17.3	.136	11	.24	-53
1.0	.08	10	11.0	3.56	130	-17.0	.141	13	.24	-65
1.5	.09	-32	10.4	3.31	106	-15.9	.160	17	.24	-91
2.0	.09	-105	9.5	2.99	84	-14.9	.179	16	.23	-115
2.5	.13	-151	8.5	2.66	70	-14.1	.197	19	.23	-133
3.0	.19	-176	7.4	2.35	51	-13.5	.212	15	.22	-145
3.5	.24	166	6.2	2.04	35	-13.0	.224	11	.23	-151
4.0	.27	152	5.1	1.80	20	-12.7	.232	6	.24	-151
5.0	.36	114	2.9	1.39	-6	-12.1	.250	-1	.25	-152
6.0	.50	88	0.8	1.10	-28	-11.8	.258	-8	.25	-166

A model for this device is available in the DEVICE MODELS section.

Features

- Cascadable 50 Ω Gain Block
- 3 dB Bandwidth: DC to 2.7 GHz
- 12.0 dB typical Gain at 1.0 GHz
- 10.0 dBm typical P_{1 dB} at 1.0 GHz
- Unconditionally Stable (k>1)
- Cost Effective Ceramic Microstrip Package

Description

Avantek's MSA-0335 is a high performance silicon bipolar Monolithic Microwave Integrated Circuit (MMIC) housed in a cost effective, microstrip package. This MODAMP™ MMIC is designed for use as a general purpose 50 Ω gain block. Typical applications include narrow and broad band IF and RF amplifiers in industrial and military applications.

The MODAMP MSA-series is fabricated using a 10 GHz f_r, 25 GHz f_{max} silicon bipolar MMIC process which utilizes nitride self-alignment, ion implantation and gold metallization to achieve excellent uniformity, performance, and reliability. The use of an external bias resistor for temperature and current stability also allows bias flexibility.

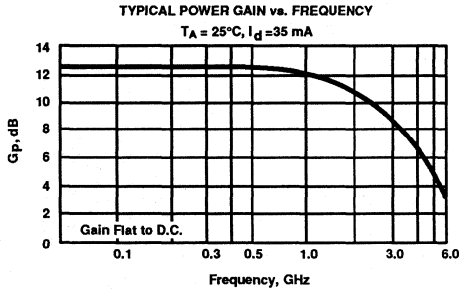

Avantek 35 micro-X Package¹

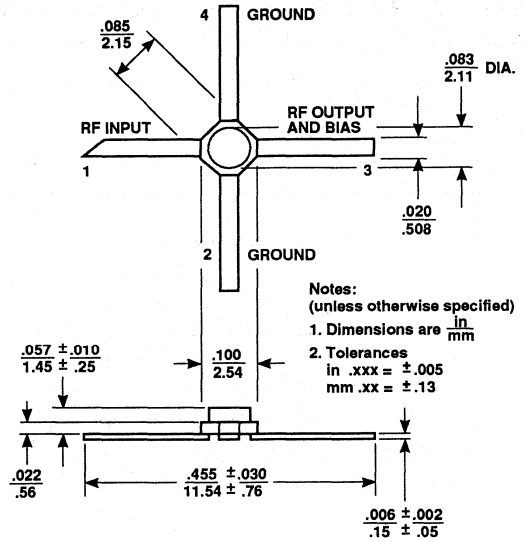

Typical Biasing Configuration

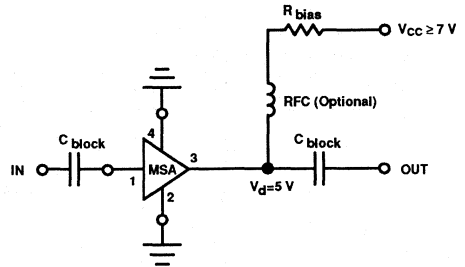

Electrical Specifications², TA = 25°C

Symbol	Parameters and Test Conditions: I _d = 35 mA, Z ₀ = 50 Ω	Units	Min.	Typ.	Max.
G _p	Power Gain (S ₂₁ ²)	f = 0.1 GHz	11.5	12.5	13.5
ΔG _p	Gain Flatness	f = 0.1 to 1.6 GHz		±0.6	±1.0
f _{3 dB}	3 dB Bandwidth			2.7	
VSWR	Input VSWR	f = 0.1 to 3.0 GHz		1.6:1	
	Output VSWR	f = 0.1 to 3.0 GHz		1.7:1	
P _{1 dB}	Output Power @ 1 dB Gain Compression	f = 1.0 GHz		10.0	
NF	50 Ω Noise Figure	f = 1.0 GHz		6.0	
IP ₃	Third Order Intercept Point	f = 1.0 GHz		23.0	
t _p	Group Delay	f = 1.0 GHz		125	
V _d	Device Voltage		4.5	5.0	5.5
dV/dT	Device Voltage Temperature Coefficient			-8.0	

Notes: 1. Short leaded 36 package available upon request.

2. The recommended operating current range for this device is 20 mA to 50 mA. Typical performance as a function of current is on the following page.

MSA-0335 MODAMP™ Cascadable Silicon Bipolar Monolithic Microwave Integrated Circuit Amplifiers

Absolute Maximum Ratings

Parameter	Absolute Maximum ¹
Device Current	80 mA
Power Dissipation ^{2,3}	425 mW
RF Input Power	+20 dBm
Junction Temperature	200°C
Storage Temperature ⁴	-65°C to 200°C

Thermal Resistance^{2,5}: $\theta_{jc} = 150^\circ\text{C}/\text{W}$

Notes:

- Permanent damage may occur if any of these limits are exceeded.
- TCASE = 25°C
- Derate at 6.7 mW/°C for $T_C > 136^\circ\text{C}$.
- Storage above +150°C may tarnish the leads of this package making it difficult to solder into a circuit.
- The small spot size of this technique results in a higher, though more accurate determination of θ_{jc} than do alternate methods. See MEASUREMENTS section "Thermal Resistance" for more information.

Typical Performance, $T_A = 25^\circ\text{C}$

(unless otherwise noted)

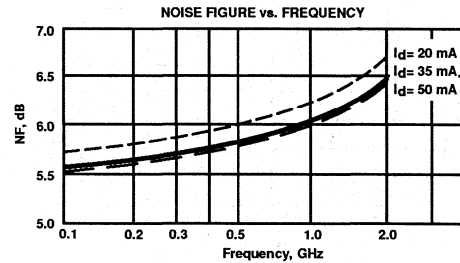
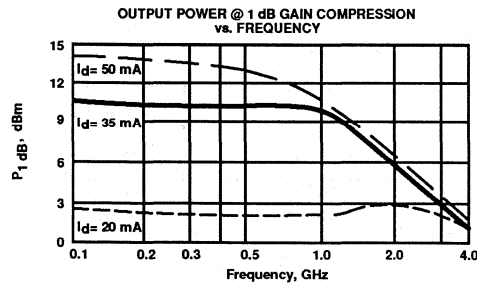
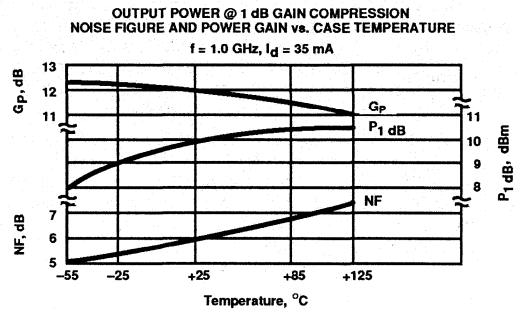
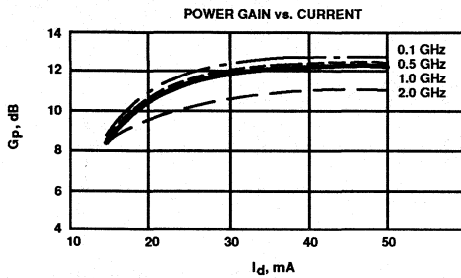
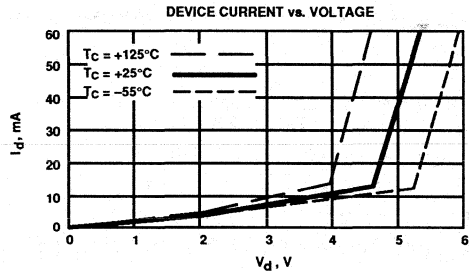

Typical Scattering Parameters: $Z_0 = 50 \Omega$

$T_A = 25^\circ\text{C}, I_d = 35 \text{ mA}$

Freq. GHz	S_{11}		S_{21}			S_{12}			S_{22}	
	Mag	Ang	dB	Mag	Ang	dB	Mag	Ang	Mag	Ang
0.1	.05	177	12.6	4.25	175	-18.6	.118	1	.17	-8
0.2	.05	170	12.5	4.24	170	-18.3	.121	2	.17	-17
0.4	.04	161	12.5	4.20	160	-18.3	.122	3	.17	-33
0.6	.04	156	12.4	4.15	151	-18.3	.121	5	.18	-47
0.8	.03	149	12.2	4.09	142	-17.9	.128	8	.19	-61
1.0	.02	154	12.1	4.02	132	-17.6	.131	9	.20	-73
1.5	.03	-104	11.6	3.79	109	-16.8	.145	13	.20	-102
2.0	.08	-136	10.9	3.49	87	-15.7	.164	11	.21	-133
2.5	.14	-157	10.0	3.16	71	-14.9	.180	13	.23	-155
3.0	.21	-176	9.0	2.81	53	-14.6	.187	8	.24	-173
3.5	.27	170	7.9	2.49	36	-13.9	.202	4	.25	178
4.0	.31	157	6.9	2.20	20	-13.6	.209	-1	.24	177
5.0	.37	125	4.9	1.76	-10	-12.9	.226	-12	.20	165
6.0	.51	87	2.8	1.38	-38	-12.8	.230	-25	.22	130

A model for this device is available in the DEVICE MODELS section.

Features

- Cascadable 50 Ω Gain Block
- 3 dB Bandwidth: DC to 2.8 GHz
- 12.0 dB typical Gain at 1.0 GHz
- 10.0 dBm typical P_{1 dB} at 1.0 GHz
- Unconditionally Stable (k>1)
- Hermetic Gold-ceramic Microstrip Package

Description

Avantek's MSA-0370 is a high performance silicon bipolar Monolithic Microwave Integrated Circuit (MMIC) housed in a hermetic, high reliability package. This MODAMP™ MMIC is designed for use as a general purpose 50 Ω gain block. Typical applications include narrow and broad band IF and RF amplifiers in industrial and military applications.

The MODAMP MSA-series is fabricated using a 10 GHz f_T, 25 GHz f_{MAX} silicon bipolar MMIC process which utilizes nitride self-alignment, ion implantation and gold metallization to achieve excellent uniformity, performance, and reliability. The use of an external bias resistor for temperature and current stability also allows bias flexibility.

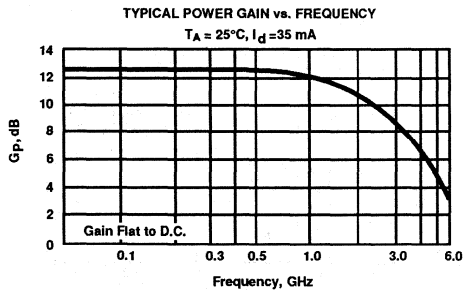
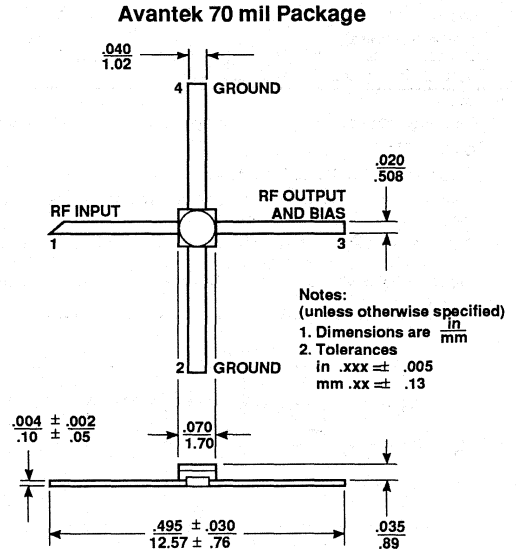

Typical Biasing Configuration

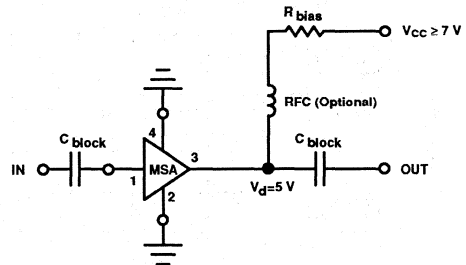

Electrical Specifications¹, T_A = 25°C

Symbol	Parameters and Test Conditions: I _d = 35 mA, Z ₀ = 50 Ω	Units	Min.	Typ.	Max.
G _p	Power Gain (S ₂₁ ²)	f = 0.1 GHz	11.5	12.5	13.5
ΔG _p	Gain Flatness	f = 0.1 to 1.8 GHz		±0.6	±1.0
f _{3 dB}	3 dB Bandwidth			2.8	
VSWR	Input VSWR	f = 0.1 to 3.0 GHz		1.8:1	
	Output VSWR	f = 0.1 to 3.0 GHz		1.8:1	
P _{1 dB}	Output Power @ 1 dB Gain Compression	f = 1.0 GHz		10.0	
NF	50 Ω Noise Figure	f = 1.0 GHz		6.0	
IP ₃	Third Order Intercept Point	f = 1.0 GHz		23.0	
t _p	Group Delay	f = 1.0 GHz		125	
V _d	Device Voltage		4.5	5.0	5.5
dV/dT	Device Voltage Temperature Coefficient			-8.0	

Note: 1. The recommended operating current range for this device is 20 mA to 50 mA. Typical performance as a function of current is on the following page.

ASA-0370 MODAMP™ Cascadable Silicon Bipolar Monolithic Microwave Integrated Circuit Amplifiers

Absolute Maximum Ratings

Parameter	Absolute Maximum ¹
Device Current	80 mA
Power Dissipation ^{2,3}	425 mW
RF Input Power	+20 dBm
Junction Temperature	200°C
Storage Temperature	-65°C to 200°C

Thermal Resistance^{2,4}: $\theta_{jc} = 125^\circ\text{C/W}$

Notes:

- Permanent damage may occur if any of these limits are exceeded.
- $T_{CASE} = 25^\circ\text{C}$
- Derate at $8 \text{ mW}/^\circ\text{C}$ for $T_C > 147^\circ\text{C}$.
- The small spot size of this technique results in a higher, though more accurate determination of θ_{jc} than do alternate methods. See MEASUREMENTS section "Thermal Resistance" for more information.

Typical Performance, $T_A = 25^\circ\text{C}$

(unless otherwise noted)

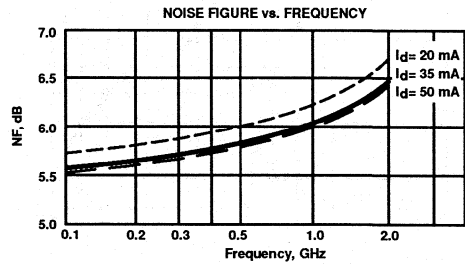
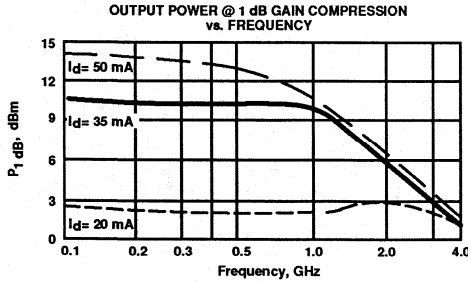
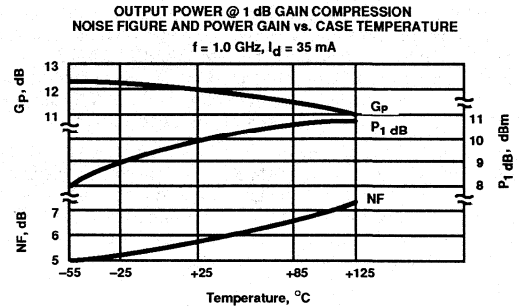
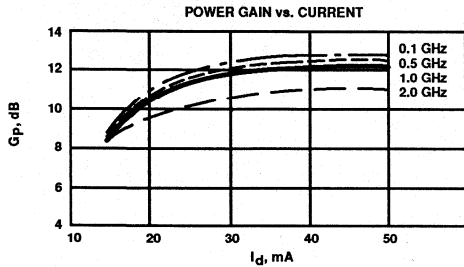
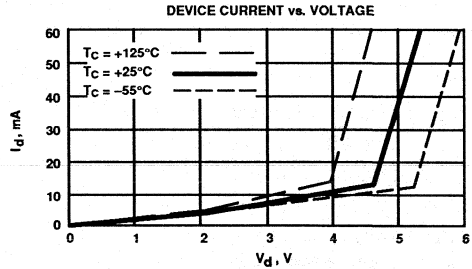

Typical Scattering Parameters: $Z_0 = 50 \Omega$

$T_A = 25^\circ\text{C}, I_d = 35 \text{ mA}$

Freq. GHz	S_{11}		S_{21}			S_{12}			S_{22}	
	Mag	Ang	dB	Mag	Ang	dB	Mag	Ang	Mag	Ang
0.1	.13	-179	12.6	4.27	176	-18.6	.118	2	.09	-14
0.2	.13	-180	12.6	4.25	171	-18.3	.121	2	.10	-29
0.4	.12	-180	12.5	4.21	162	-18.4	.121	4	.12	-52
0.6	.11	-178	12.4	4.17	154	-18.2	.123	6	.14	-70
0.8	.11	-174	12.3	4.11	146	-17.8	.129	8	.17	-82
1.0	.10	-168	12.2	4.06	137	-17.7	.130	8	.20	-92
1.5	.11	-149	11.7	3.85	116	-17.1	.140	11	.24	-114
2.0	.16	-147	11.1	3.57	96	-16.2	.155	11	.27	-134
2.5	.22	-151	10.3	3.27	82	-15.6	.167	14	.27	-146
3.0	.28	-160	9.3	2.91	65	-15.2	.174	11	.27	-159
3.5	.33	-169	8.2	2.58	48	-14.5	.188	7	.26	-163
4.0	.36	-177	7.1	2.27	34	-14.3	.192	3	.25	-162
5.0	.38	163	5.1	1.81	9	-13.8	.203	-5	.23	-153
6.0	.39	132	3.4	1.48	-14	-13.5	.213	-13	.24	-160

A model for this device is available in the DEVICE MODELS section.

Features

- Cascadable 50 Ω Gain Block
- 3 dB Bandwidth: DC to 2.5 GHz
- 12.0 dB typical Gain at 1.0 GHz
- 10.0 dBm typical P_{1 dB} at 1.0 GHz
- Unconditionally Stable (k>1)
- Low Cost Plastic Package

Description

Avantek's MSA-0385 is a high performance silicon bipolar Monolithic Microwave Integrated Circuit (MMIC) housed in a low cost plastic package. This MODAMP™ MMIC is designed for use as a general purpose 50 Ω gain block. Typical applications include narrow and broad band IF and RF amplifiers in commercial and industrial applications.

The MODAMP MSA-series is fabricated using a 10 GHz f_T, 25 GHz f_{MAX} silicon bipolar MMIC process which utilizes nitride self-alignment, ion implantation and gold metallization to achieve excellent uniformity, performance, and reliability. The use of an external bias resistor for temperature and current stability also allows bias flexibility.

Avantek 85 Plastic Package

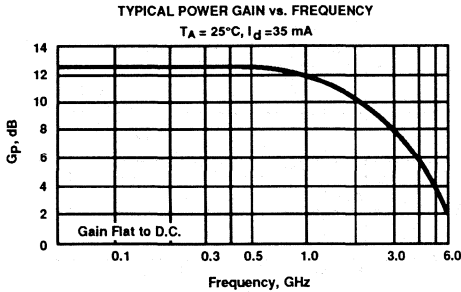
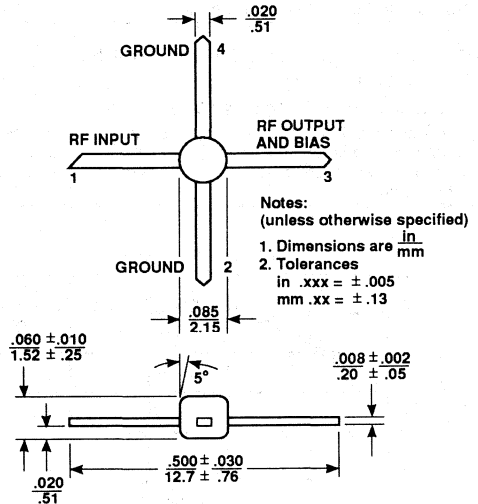

Typical Biasing Configuration

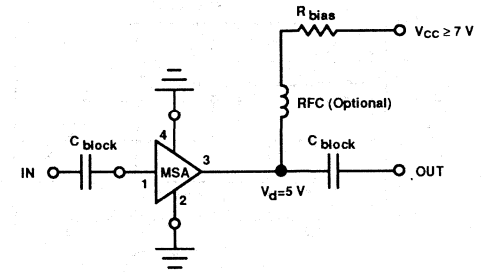

Electrical Specifications¹, T_A = 25°C

Symbol	Parameters and Test Conditions: I _d = 35 mA, Z _O = 50 Ω	Units	Min.	Typ.	Max.
G _p	Power Gain (S ₂₁ ²) f = 0.1 GHz f = 1.0 GHz	dB	10.0	12.5 12.0	
ΔG _p	Gain Flatness f = 0.1 to 1.6 GHz	dB		±0.7	
f _{3 dB}	3 dB Bandwidth	GHz		2.5	
VSWR	Input VSWR f = 0.1 to 3.0 GHz			1.5:1	
	Output VSWR f = 0.1 to 3.0 GHz			1.7:1	
P _{1 dB}	Output Power @ 1 dB Gain Compression f = 1.0 GHz	dBm		10.0	
NF	50 Ω Noise Figure f = 1.0 GHz	dB		6.0	
IP ₃	Third Order Intercept Point f = 1.0 GHz	dBm		23.0	
t _D	Group Delay f = 1.0 GHz	psec.		125	
V _d	Device Voltage	V	4.0	5.0	6.0
dV/dT	Device Voltage Temperature Coefficient	mV/°C		-8.0	

Note: 1. The recommended operating current range for this device is 20 mA to 50 mA. Typical performance as a function of current is on the following page.

MSA-0385 MODAMP™ Cascadable Silicon Bipolar Monolithic Microwave Integrated Circuit Amplifiers

Absolute Maximum Ratings

Parameter	Absolute Maximum ¹
Device Current	70 mA
Power Dissipation ^{2,3}	400 mW
RF Input Power	+20 dBm
Junction Temperature	150°C
Storage Temperature	-65°C to 150°C

Thermal Resistance^{2,4}: $\theta_{JC} = 105^\circ\text{C/W}$

Notes:

- Permanent damage may occur if any of these limits are exceeded.
- $T_{CASE} = 25^\circ\text{C}$
- Derate at $9.5 \text{ mW}/^\circ\text{C}$ for $T_C > 108^\circ\text{C}$.
- See MEASUREMENTS section "Thermal Resistance" for more information.

Typical Performance, $T_A = 25^\circ\text{C}$

(unless otherwise noted)

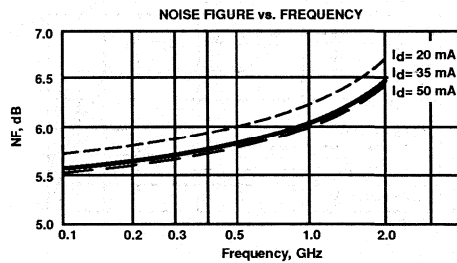
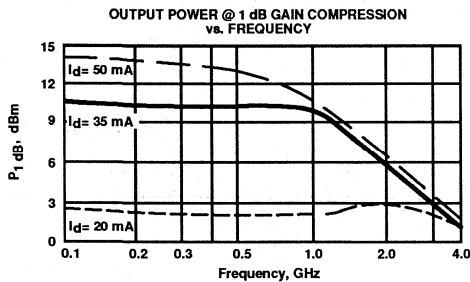
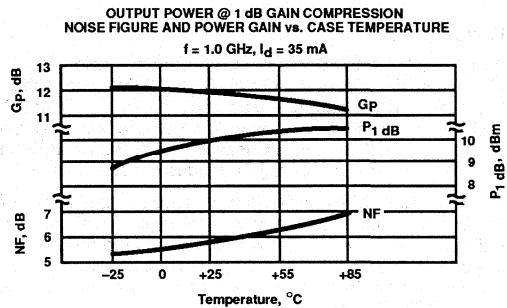
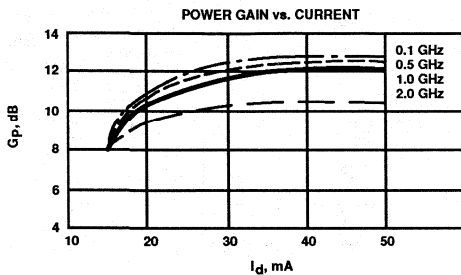
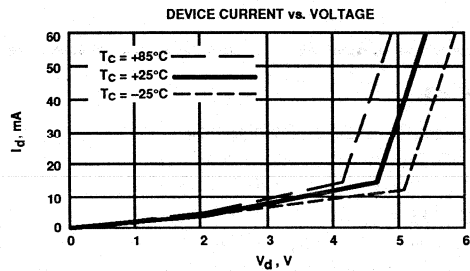

Typical Scattering Parameters: $Z_0 = 50 \Omega$

$T_A = 25^\circ\text{C}, I_d = 35 \text{ mA}$

Freq. GHz	S_{11}		S_{21}			S_{12}			S_{22}	
	Mag	Ang	dB	Mag	Ang	dB	Mag	Ang	Mag	Ang
0.1	.09	178	12.6	4.26	175	-18.1	.124	2	.13	-10
0.2	.09	171	12.5	4.24	170	-18.4	.120	3	.13	-20
0.4	.08	166	12.4	4.17	161	-18.4	.121	6	.14	-41
0.6	.07	160	12.3	4.10	151	-18.0	.126	8	.15	-57
0.8	.07	155	12.1	4.01	142	-17.9	.127	12	.16	-71
1.0	.06	152	11.9	3.92	133	-17.6	.132	12	.18	-84
1.5	.05	-169	11.2	3.63	112	-16.5	.149	18	.21	-112
2.0	.08	-174	10.4	3.29	92	-15.6	.167	19	.23	-136
2.5	.12	-173	9.5	2.98	79	-14.6	.186	22	.25	-150
3.0	.20	178	8.4	2.64	63	-14.1	.198	20	.26	-166
3.5	.25	170	7.5	2.36	47	-13.5	.211	17	.25	-174
4.0	.28	160	6.5	2.12	33	-13.0	.224	13	.24	-180
5.0	.42	134	4.7	1.71	7	-12.2	.247	4	.20	168
6.0	.50	99	2.7	1.37	-18	-12.0	.252	-7	.23	133

A model for this device is available in the DEVICE MODELS section.

Features

- Cascadable 50 Ω Gain Block
- 3 dB Bandwidth: DC to 2.4 GHz
- 12.0 dB typical Gain at 1.0 GHz
- 10.0 dBm typical P_{1 dB} at 1.0 GHz
- Unconditionally Stable (k>1)
- Surface Mount Plastic Package
- Tape-and-Reel Packaging Option Available¹

Description

Avantek's MSA-0386 is a high performance silicon bipolar Monolithic Microwave Integrated Circuit (MMIC) housed in a low cost, surface mount plastic package. This MODAMP™ MMIC is designed for use as a general purpose 50 Ω gain block. Applications include narrow and broad band IF and RF amplifiers in commercial and industrial applications.

The MODAMP MSA-series is fabricated using a 10 GHz f_r, 25 GHz f_{max} silicon bipolar MMIC process which utilizes nitride self-alignment, ion implantation and gold metallization to achieve excellent uniformity, performance, and reliability. The use of an external bias resistor for temperature and current stability also allows bias flexibility.

Avantek 86 Plastic Package

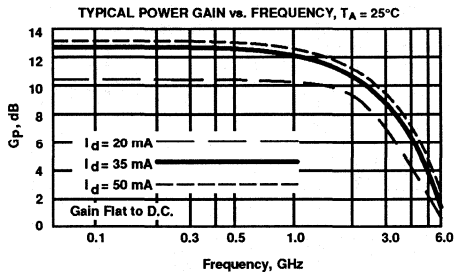
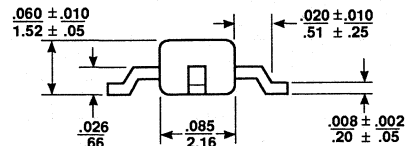
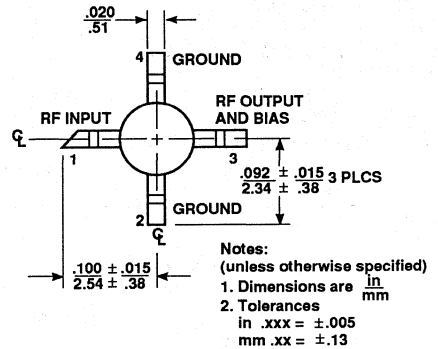

Typical Biasing Configuration

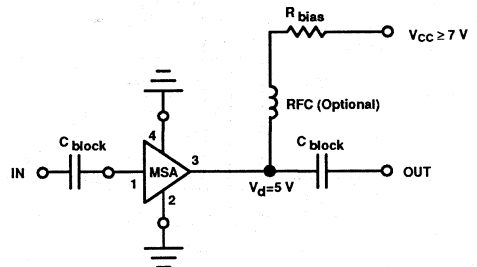

Electrical Specifications², T_A = 25°C

Symbol	Parameters and Test Conditions: I _d = 35 mA, Z ₀ = 50 Ω	Units	Min.	Typ.	Max.
G _p	Power Gain (S ₂₁ ²) f = 0.1 GHz f = 1.0 GHz	dB	10.0	12.5 12.0	
ΔG _p	Gain Flatness f = 0.1 to 1.6 GHz	dB		±0.7	
f _{3 dB}	3 dB Bandwidth	GHz		2.4	
VSWR	Input VSWR f = 0.1 to 3.0 GHz			1.5:1	
	Output VSWR f = 0.1 to 3.0 GHz			1.7:1	
P _{1 dB}	Output Power @ 1 dB Gain Compression f = 1.0 GHz	dBm		10.0	
NF	50 Ω Noise Figure f = 1.0 GHz	dB		6.0	
IP ₃	Third Order Intercept Point f = 1.0 GHz	dBm		23.0	
t _p	Group Delay f = 1.0 GHz	psec.		140	
V _d	Device Voltage	V	4.0	5.0	6.0
dV/dT	Device Voltage Temperature Coefficient	mV/°C		-8.0	

Notes: 1. Refer to PACKAGING section "Tape-and-Reel Packaging for Surface Mount Semiconductors".
 2. The recommended operating current range for this device is 20 mA to 50 mA. Typical performance as a function of current is on the following page.

MSA-0386 MODAMP™ Cascadable Silicon Bipolar Monolithic Microwave Integrated Circuit Amplifiers

Absolute Maximum Ratings

Parameter	Absolute Maximum ¹
Device Current	70 mA
Power Dissipation ^{2,3}	400 mW
RF Input Power	+20 dBm
Junction Temperature	150°C
Storage Temperature	-65°C to 150°C
Thermal Resistance ^{2,4} : $\theta_{JC} = 115^\circ\text{C}/\text{W}$	

Notes:

1. Permanent damage may occur if any of these limits are exceeded.
2. T_{CASE} = 25°C
3. Derate at 8.7 mW/°C for T_C > 104°C.
4. See MEASUREMENTS section "Thermal Resistance" for more information.

Part Number Ordering Information

Part Number	Devices Per Reel	Reel Size
MSA-0386-TR1	1000	7"
MSA-0386-TR2	4000	13"

Typical Performance, T_A = 25°C

(unless otherwise noted)

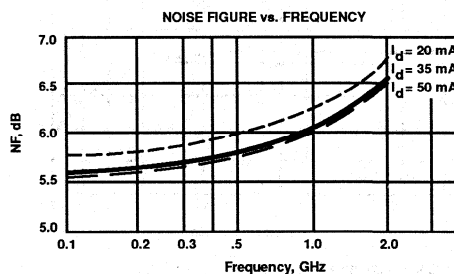
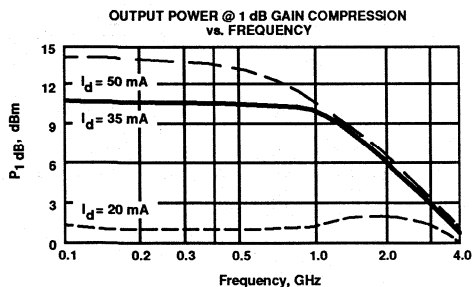
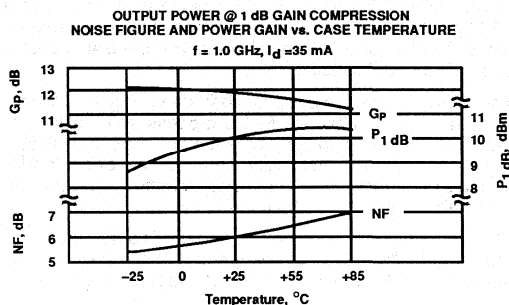
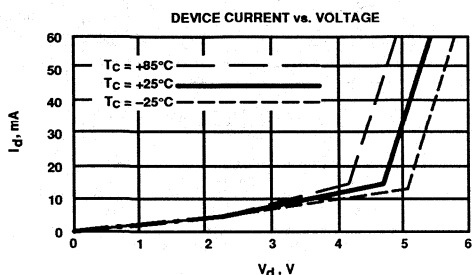

Typical Scattering Parameters: Z₀ = 50 Ω

T_A = 25°C, I_d = 35 mA

Freq. GHz	S ₁₁		S ₂₁			S ₁₂			S ₂₂	
	Mag	Ang	dB	Mag	Ang	dB	Mag	Ang	Mag	Ang
0.1	.11	174	12.5	4.22	175	-18.3	.122	1	.13	-11
0.2	.11	169	12.5	4.20	170	-18.2	.124	2	.13	-20
0.4	.11	159	12.4	4.16	159	-18.1	.124	5	.14	-41
0.6	.10	149	12.2	4.09	149	-17.9	.128	8	.15	-60
0.8	.10	142	12.1	4.00	139	-17.6	.131	9	.16	-78
1.0	.09	137	11.9	3.93	129	-17.4	.136	11	.18	-93
1.5	.09	139	11.2	3.61	106	-16.6	.149	14	.20	-129
2.0	.12	149	10.3	3.28	83	-15.3	.171	13	.23	-157
2.5	.18	150	9.4	2.95	66	-14.4	.190	12	.26	-176
3.0	.25	142	8.3	2.60	48	-13.7	.207	9	.29	167
3.5	.32	133	7.2	2.29	31	-13.2	.219	3	.30	152
4.0	.40	124	6.0	2.01	15	-13.0	.224	-1	.31	142
5.0	.53	106	3.7	1.53	-13	-12.8	.228	-11	.32	128

A model for this device is available in the DEVICE MODELS section.

Features

- Cascadable 50 Ω Gain Block
- 3 dB Bandwidth: DC to 4.0 GHz
- 16.0 dBm typical $P_{1\text{ dB}}$ at 1.0 GHz
- 8.5 dB typical Gain at 1.0 GHz

Description

Avantek's MSA-0400 is a high performance silicon bipolar Monolithic Microwave Integrated Circuit (MMIC) chip. This MODAMP™ MMIC is designed for use as a general purpose 50 Ω gain block. Typical applications include narrow and broad band IF and RF amplifiers in commercial, industrial and military applications.

The MODAMP MSA-series is fabricated using a 10 GHz f_T , 25 GHz f_{MAX} silicon bipolar MMIC process which utilizes nitride self-alignment, ion implantation and gold metallization to achieve excellent uniformity, performance, and reliability. The use of an external bias resistor for temperature and current stability also allows bias flexibility.

The recommended assembly procedure is gold-eutectic die attach at 400°C and either wedge or ball bonding using 0.7 mil gold wire. See APPLICATIONS section, "Chip Use".

Avantek Chip Outline¹

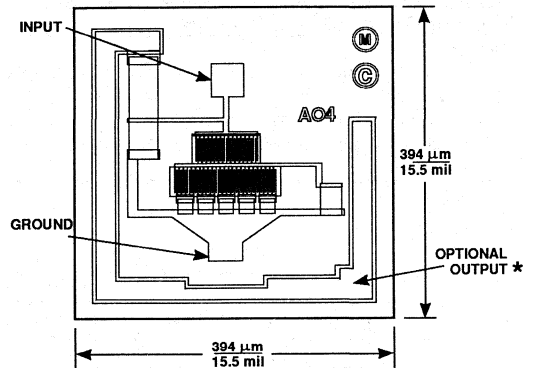

Unless otherwise specified, tolerances are $\pm 13 \mu\text{m}$ / ± 0.5 mils.
Chip thickness is $114 \mu\text{m}$ / 4.5 mil. Bond pads are $41 \mu\text{m}$ / 1.6 mil typical on each side.

* Output contact is made by die attaching the backside of the die.

TYPICAL POWER GAIN vs. FREQUENCY

$T_A = 25^\circ\text{C}$, $I_d = 90 \text{ mA}$

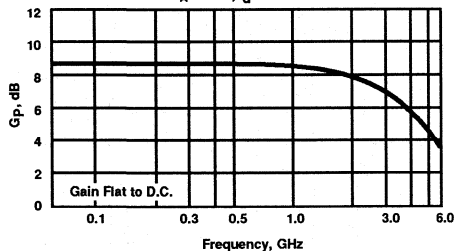

Typical Biasing Configuration

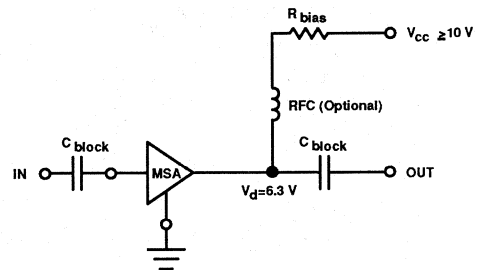

Electrical Specifications², $T_A = 25^\circ\text{C}$

Symbol	Parameters and Test Conditions ³ : $I_d = 90 \text{ mA}$, $Z_0 = 50 \Omega$	Units	Min.	Typ.	Max.
G_p	Power Gain ($ S_{21} ^2$) $f = 0.1 \text{ GHz}$	dB		8.5	
ΔG_p	Gain Flatness $f = 0.1$ to 2.5 GHz	dB		± 0.6	
$f_3 \text{ dB}$	3 dB Bandwidth	GHz		4.3	
VSWR	Input VSWR $f = 0.1$ to 2.5 GHz			1.7:1	
	Output VSWR $f = 0.1$ to 2.5 GHz			1.8:1	
$P_{1\text{ dB}}$	Output Power @ 1 dB Gain Compression $f = 1.0 \text{ GHz}$, $I_d = 50 \text{ mA}$	dBm		12.5	
	Output Power @ 1 dB Gain Compression $f = 1.0 \text{ GHz}$, $I_d = 90 \text{ mA}$	dBm		16.0	
NF	50 Ω Noise Figure $f = 1.0 \text{ GHz}$	dB		6.5	
IP_3	Third Order Intercept Point $f = 1.0 \text{ GHz}$	dBm		30.0	
t_D	Group Delay $f = 1.0 \text{ GHz}$	psec.		140	
V_d	Device Voltage	V	5.7	6.3	6.9
dV/dT	Device Voltage Temperature Coefficient	mV/°C		-8.0	

Notes: 1. Refer to the APPLICATIONS section "MODAMP™ Silicon MMIC Chip Use" for additional information.

2. The recommended operating current range for this device is 40 mA to 110 mA. Typical performance as a function of current is on the following page.

3. RF performance of the chip is determined by packaging and testing 10 devices per wafer in a dual ground configuration.

MSA-0400 MODAMP™ Cascadable Silicon Bipolar Monolithic Microwave Integrated Circuit Amplifiers

Absolute Maximum Ratings

Parameter	Absolute Maximum ¹
Device Current	120 mA
Power Dissipation ^{2,3}	850 mW
RF Input Power	+20 dBm
Junction Temperature	200°C
Storage Temperature	-65°C to 200°C

Thermal Resistance^{2,4}: $\theta_{jC} = 35^\circ\text{C/W}$

Notes:

- Permanent damage may occur if any of these limits are exceeded.
- T_{MOUNTING SURFACE} = 25°C
- Derate at 28.6 mW/°C for T_{MOUNTING SURFACE} > 170°C.
- The small spot size of this technique results in a higher, though more accurate determination of θ_{jC} than do alternate methods. See MEASUREMENTS section "Thermal Resistance" for more information.

Part Number Ordering Information

Part Number	Devices Per Tray
MSA-0400-GP2	10
MSA-0400-GP4	100
MSA-0400-GP6	up to 300

Typical Performance, T_A = 25°C

(unless otherwise noted)

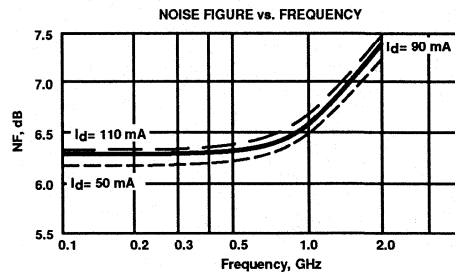
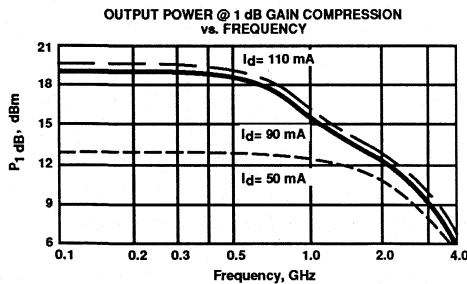
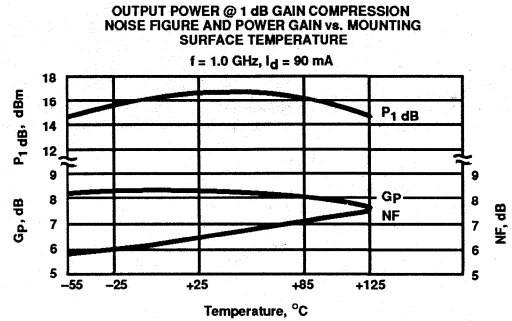
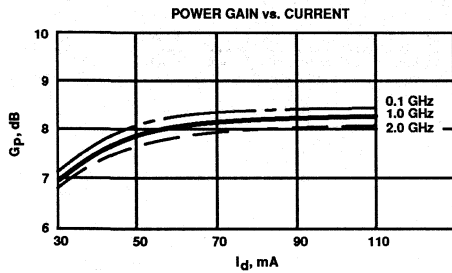

**MSA-0400 MODAMP™ Cascadable Silicon Bipolar
Monolithic Microwave Integrated Circuit Amplifiers**

Typical Scattering Parameters: $Z_0 = 50 \Omega$

$T_A = 25^\circ\text{C}$, $I_d = 50 \text{ mA}^4$

Freq. GHz	S_{11}		S_{21}			S_{12}			S_{22}		k
	Mag	Ang	dB	Mag	Ang	dB	Mag	Ang	Mag	Ang	
0.1	.18	179	8.6	2.68	177	-16.4	.151	1	.10	-13	1.37
0.5	.18	-179	8.6	2.68	163	-16.3	.153	7	.16	-54	1.34
1.0	.16	-171	8.5	2.65	145	-15.8	.161	10	.22	-83	1.28
1.5	.16	-161	8.4	2.63	127	-15.4	.169	16	.29	-101	1.19
2.0	.21	-156	8.2	2.56	109	-14.6	.187	18	.33	-119	1.07
2.5	.27	-152	7.8	2.45	98	-13.8	.205	24	.37	-128	0.98
3.0	.33	-159	7.0	2.23	82	-13.4	.213	24	.42	-140	0.91
4.0	.42	-171	5.2	1.81	54	-12.5	.237	21	.42	-151	0.86
5.0	.45	172	3.4	1.49	33	-11.7	.259	17	.38	-153	0.94

Typical Scattering Parameters: $Z_0 = 50 \Omega$

$T_A = 25^\circ\text{C}$, $I_d = 90 \text{ mA}^5$

Freq. GHz	S_{11}		S_{21}			S_{12}			S_{22}		k
	Mag	Ang	dB	Mag	Ang	dB	Mag	Ang	Mag	Ang	
0.1	.25	179	8.7	2.73	177	-16.4	.152	2	.03	-36	1.33
0.5	.24	173	8.8	2.76	164	-16.3	.153	5	.10	-83	1.31
1.0	.22	166	8.8	2.74	148	-15.9	.160	10	.19	-91	1.26
1.5	.16	164	8.8	2.74	132	-15.3	.172	16	.27	-94	1.18
2.0	.13	173	8.7	2.73	116	-14.5	.189	22	.32	-98	1.10
2.5	.12	-162	8.3	2.60	106	-13.9	.203	31	.36	-95	1.04
3.0	.14	-147	8.0	2.50	90	-13.1	.222	33	.40	-95	0.97
4.0	.17	-154	6.7	2.17	64	-10.9	.286	36	.43	-93	0.87
5.0	.20	146	5.2	1.83	41	-9.2	.346	36	.40	-94	0.89

Notes: 4. S-parameters are de-embedded from 70 mil package measured data using the package model found in the DEVICE MODELS section.

5. S-parameters are de-embedded from 200 mil BeO package measured data using the package model found in the DEVICE MODELS section.



This page is intentionally blank.

Features

- Cascadable 50 Ω Gain Block
- 3 dB Bandwidth: DC to 2.5 GHz
- 11.5 dBm typical P_{1 dB} at 1.0 GHz
- 7.5 dB typical Gain at 1.0 GHz
- Unconditionally Stable (k>1)
- Low Cost Plastic Package

Description

Avantek's MSA-0404 is a high performance silicon bipolar Monolithic Microwave Integrated Circuit (MMIC) housed in a low cost plastic package. This MODAMP™ MMIC is designed for use as a general purpose 50 Ω gain block. Typical applications include narrow and broad band IF and RF amplifiers in commercial and industrial applications.

The MODAMP MSA-series is fabricated using a 10 GHz f_T, 25 GHz f_{MAX} silicon bipolar MMIC process which utilizes nitride self-alignment, ion implantation and gold metallization to achieve excellent uniformity, performance, and reliability. The use of an external bias resistor for temperature and current stability also allows bias flexibility.

Avantek 04 Plastic Package

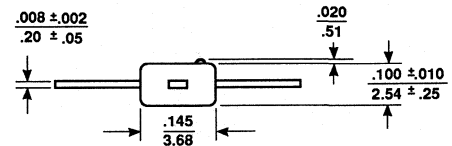
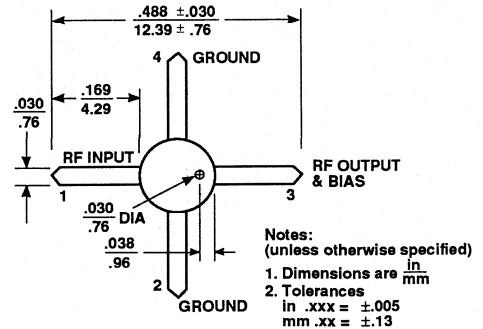

TYPICAL POWER GAIN vs. FREQUENCY
 T_A = 25°C, I_d = 50 mA

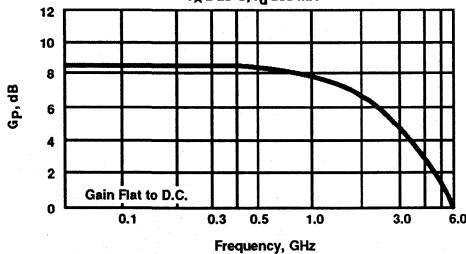

Typical Biasing Configuration

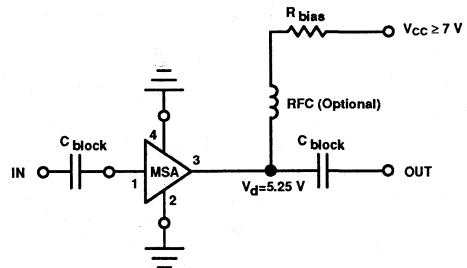

Electrical Specifications¹, T_A = 25°C

Symbol	Parameters and Test Conditions: I _d = 50 mA, Z _O = 50 Ω	Units	Min.	Typ.	Max.
GP	Power Gain (S ₂₁ ²) f = 0.1 GHz f = 0.5 GHz f = 1.0 GHz	dB	7.0	8.3 8.0 7.5	
ΔGP	Gain Flatness f = 0.1 to 2.0 GHz	dB		±1.0	
f _{3 dB}	3 dB Bandwidth	GHz		2.5	
VSWR	Input VSWR f = 0.1 to 2.5 GHz			1.4:1	
	Output VSWR f = 0.1 to 2.5 GHz			1.8:1	
P _{1 dB}	Output Power @ 1 dB Gain Compression f = 1.0 GHz	dBm		11.5	
NF	50 Ω Noise Figure f = 1.0 GHz	dB		7.0	
IP ₃	Third Order Intercept Point f = 1.0 GHz	dBm		24.5	
t _D	Group Delay f = 1.0 GHz	psec		150	
V _d	Device Voltage	V	4.75	5.25	5.75
dV/dT	Device Voltage Temperature Coefficient	mV/°C		-8.0	

Note: 1. The recommended operating current range for this device is 30 mA to 70 mA. Typical performance as a function of current is on the following page.

MSA-0404 MODAMPT™ Cascadable Silicon Bipolar Monolithic Microwave Integrated Circuit Amplifiers

Absolute Maximum Ratings

Parameter	Absolute Maximum ¹
Device Current	85 mA
Power Dissipation ^{2,3}	500 mW
RF Input Power	+20 dBm
Junction Temperature	150°C
Storage Temperature	-65°C to 150°C
Thermal Resistance ^{2,4} : $\theta_{jc} = 85^\circ\text{C/W}$	

Notes:

1. Permanent damage may occur if any of these limits are exceeded.
2. TCASE = 25°C
3. Derate at 11.8 mW/°C for TC > 108°C.
4. See MEASUREMENTS section "Thermal Resistance" for more information.

Typical Performance, TA = 25°C

(unless otherwise noted)

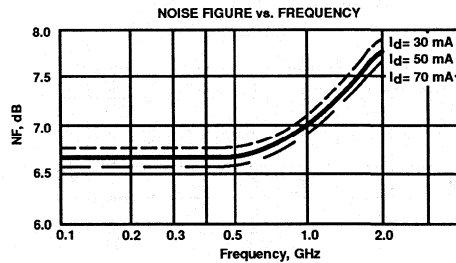
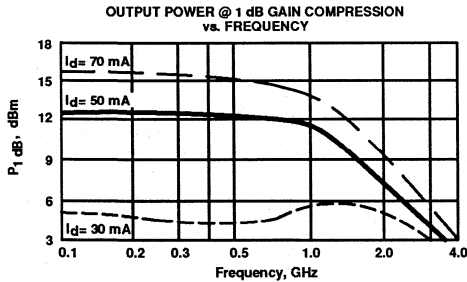
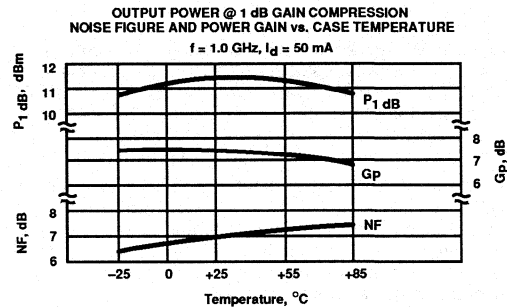
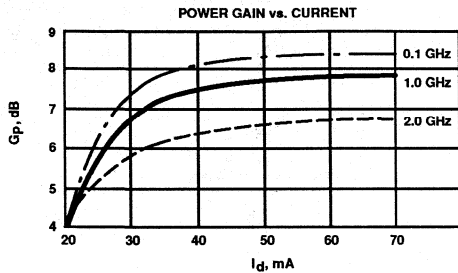
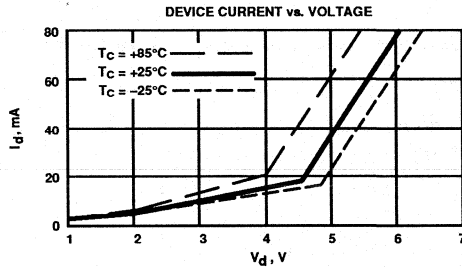

Typical Scattering Parameters: $Z_0 = 50 \Omega$

$T_A = 25^\circ\text{C}, I_d = 50 \text{ mA}$

Freq. GHz	S_{11}		S_{21}			S_{12}			S_{22}	
	Mag	Ang	dB	Mag	Ang	dB	Mag	Ang	Mag	Ang
0.1	.16	175	8.3	2.59	174	-16.2	.156	0	.13	-13
0.2	.16	170	8.2	2.58	168	-16.2	.155	2	.13	-25
0.4	.15	161	8.1	2.54	156	-16.0	.158	4	.14	-47
0.6	.14	152	8.0	2.51	145	-16.0	.158	6	.16	-64
0.8	.12	145	7.8	2.46	133	-15.8	.163	8	.19	-79
1.0	.11	141	7.7	2.41	122	-15.4	.169	9	.21	-91
1.5	.07	141	7.2	2.29	96	-14.6	.186	13	.24	-118
2.0	.09	161	6.6	2.14	71	-13.3	.215	12	.26	-140
2.5	.14	159	5.9	1.98	53	-12.4	.240	13	.28	-157
3.0	.22	146	5.1	1.80	33	-11.7	.260	7	.29	-176
3.5	.30	128	4.3	1.64	13	-10.9	.286	0	.32	167
4.0	.38	109	3.2	1.45	-6	-10.4	.301	-7	.33	153
5.0	.47	91	2.1	1.27	-23	-10.2	.310	-15	.35	137
6.0	.55	75	1.0	1.09	-39	-10.1	.312	-24	.37	120

A model for this device is available in the DEVICE MODELS section.

Features

- Cascadable 50 Ω Gain Block
- 3 dB Bandwidth: DC to 4.0 GHz
- 16.0 dBm typical $P_{1\text{ dB}}$ at 1.0 GHz
- 8.5 dB typical Gain at 1.0 GHz
- Unconditionally Stable ($k > 1$)
- Hermetic Metal/Beryllia Microstrip Package

Description

Avantek's MSA-0420 is a high performance silicon bipolar Monolithic Microwave Integrated Circuit (MMIC) housed in a hermetic, high reliability package. This MODAMP™ MMIC is designed for use as a general purpose 50 Ω gain block. Typical applications include narrow and broad band IF and RF amplifiers in industrial and military applications.

The MODAMP MSA-series is fabricated using a 10 GHz f_T , 25 GHz f_{MAX} silicon bipolar MMIC process which utilizes nitride self-alignment, ion implantation and gold metallization to achieve excellent uniformity, performance, and reliability. The use of an external bias resistor for temperature and current stability also allows bias flexibility.

Avantek 200 mil BeO Package

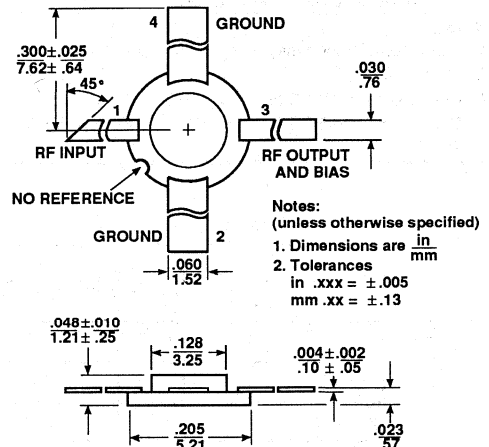

TYPICAL POWER GAIN vs. FREQUENCY
 $T_A = 25^\circ\text{C}$, $I_d = 90\text{ mA}$

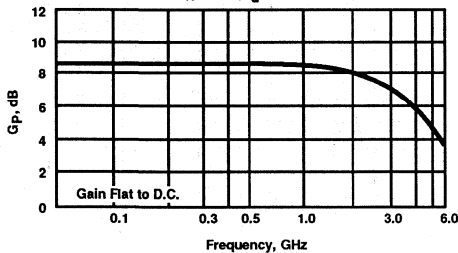

Typical Biasing Configuration

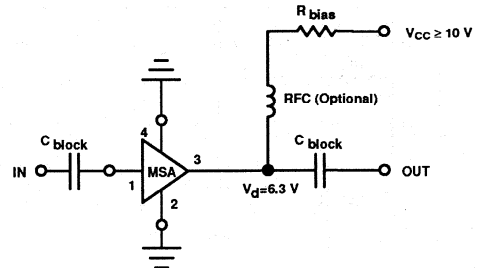

Electrical Specifications¹, $T_A = 25^\circ\text{C}$

Symbol	Parameters and Test Conditions: $I_d = 90\text{ mA}$, $Z_0 = 50\ \Omega$	Units	Min.	Typ.	Max.
G_p	Power Gain ($ S_{21} ^2$) $f = 0.1\text{ GHz}$	dB	7.5	8.5	9.5
ΔG_p	Gain Flatness $f = 0.1\text{ to }2.5\text{ GHz}$	dB		± 0.6	± 1.0
$f_3\text{ dB}$	3 dB Bandwidth	GHz		4.3	
VSWR	Input VSWR $f = 0.1\text{ to }2.5\text{ GHz}$			1.7:1	
	Output VSWR $f = 0.1\text{ to }2.5\text{ GHz}$			1.8:1	
$P_{1\text{ dB}}$	Output Power @ 1 dB Gain Compression $f = 1.0\text{ GHz}$	dBm	14.0	16.0	
NF	50 Ω Noise Figure $f = 1.0\text{ GHz}$	dB		6.5	
IP_3	Third Order Intercept Point $f = 1.0\text{ GHz}$	dBm		30.0	
t_D	Group Delay $f = 1.0\text{ GHz}$	psec.		140	
V_d	Device Voltage	V	5.7	6.3	6.9
dV/dT	Device Voltage Temperature Coefficient	mV/°C		-8.0	

Note: 1. The recommended operating current range for this device is 40 mA to 110 mA. Typical performance as a function of current is on the following page.

MSA-0420 MODAMP™ Cascadable Silicon Bipolar Monolithic Microwave Integrated Circuit Amplifiers

Absolute Maximum Ratings

Parameter	Absolute Maximum ¹
Device Current	120 mA
Power Dissipation ^{2,3}	850 mW
RF Input Power	+20 dBm
Junction Temperature	200°C
Storage Temperature	-65°C to 200°C

Thermal Resistance^{2,4}: $\theta_{jC} = 40^\circ\text{C/W}$

Notes:

1. Permanent damage may occur if any of these limits are exceeded.
2. TCASE = 25°C
3. Derate at 25 mW/°C for TC > 166°C.
4. The small spot size of this technique results in a higher, though more accurate determination of θ_{jC} than do alternate methods. See MEASUREMENTS section "Thermal Resistance" for more information.

Typical Performance, T_A = 25°C

(unless otherwise noted)

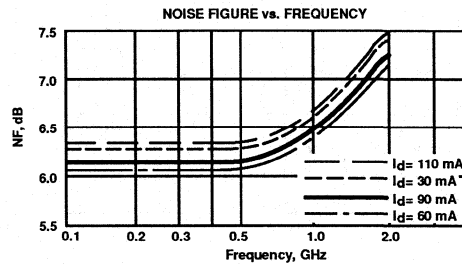
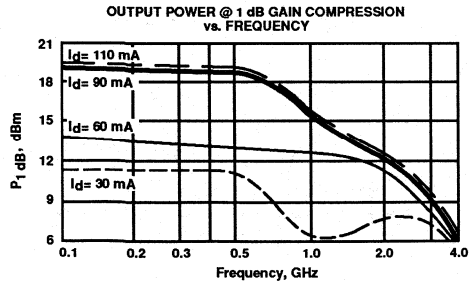
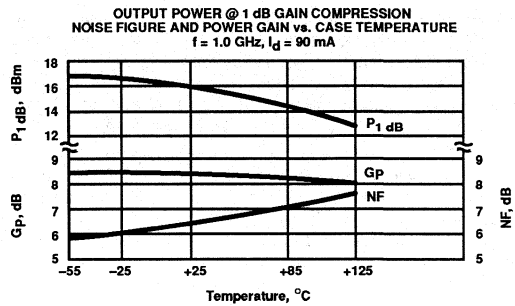
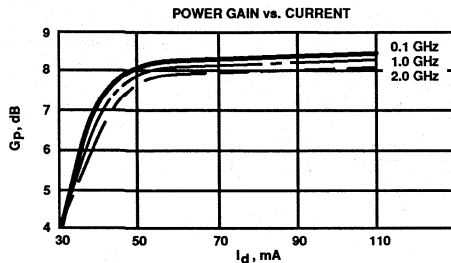
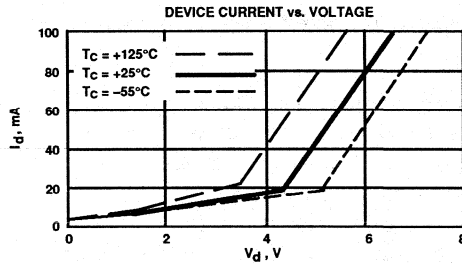

Typical Scattering Parameters: Z₀ = 50 Ω

T_A = 25°C, I_d = 90 mA

Freq. GHz	S ₁₁		S ₂₁		S ₁₂		S ₂₂	
	Mag	Ang	dB	Mag	Ang	dB	Mag	Ang
0.1	.25	177	8.6	2.70	175	-16.4	.151	1
0.2	.25	173	8.6	2.69	170	-16.5	.150	1
0.4	.24	167	8.6	2.69	159	-16.5	.150	-1
0.6	.22	160	8.5	2.67	149	-16.4	.152	-2
0.8	.21	154	8.5	2.66	139	-16.3	.154	-2
1.0	.20	148	8.3	2.60	129	-16.1	.156	-3
1.5	.14	136	8.1	2.54	104	-15.6	.166	-4
2.0	.10	136	7.9	2.48	80	-14.8	.181	-6
2.5	.08	161	7.4	2.34	62	-14.3	.193	-5
3.0	.10	178	7.0	2.24	39	-13.7	.206	-11
3.5	.13	176	6.6	2.13	18	-12.6	.233	-18
4.0	.14	163	5.9	1.97	-3	-11.9	.253	-25
4.5	.14	133	5.3	1.83	-23	-11.3	.273	-33
5.0	.16	91	4.5	1.69	-43	-10.5	.299	-43

A model for this device is available in the DEVICE MODELS section.

Features

- Cascadable 50 Ω Gain Block
- 3 dB Bandwidth: DC to 3.8 GHz
- 12.5 dBm typical P_{1 dB} at 1.0 GHz
- 8.5 dB typical Gain at 1.0 GHz
- Unconditionally Stable (k>1)
- Cost Effective Ceramic Microstrip Package

Description

Avantek's MSA-0435 is a high performance silicon bipolar Monolithic Microwave Integrated Circuit (MMIC) housed in a cost effective, microstrip package. This MODAMP™ MMIC is designed for use as a general purpose 50 Ω gain block. Typical applications include narrow and broad band IF and RF amplifiers in industrial and military applications.

The MODAMP MSA-series is fabricated using a 10 GHz f_T, 25 GHz f_{MAX} silicon bipolar MMIC process which utilizes nitride self-alignment, ion implantation and gold metallization to achieve excellent uniformity, performance, and reliability. The use of an external bias resistor for temperature and current stability also allows bias flexibility.

Avantek 35 micro-X Package¹

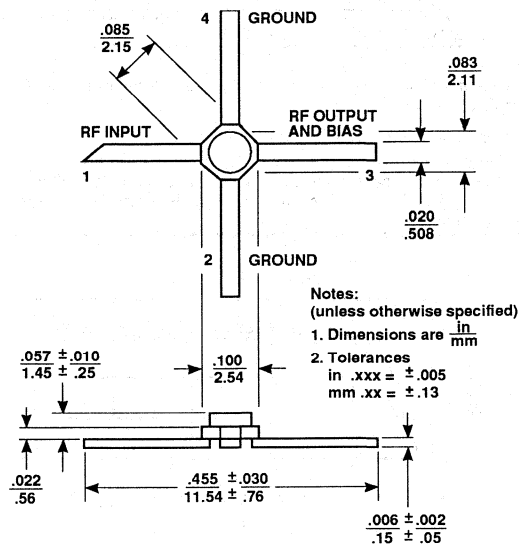

TYPICAL POWER GAIN vs. FREQUENCY

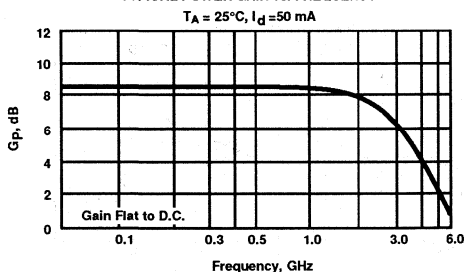

Typical Biasing Configuration

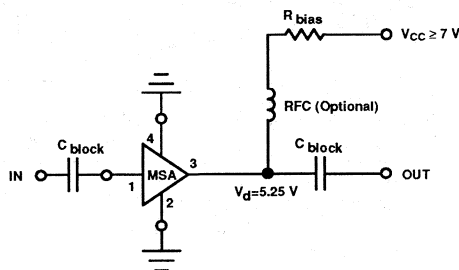

Electrical Specifications², T_A = 25°C

Symbol	Parameters and Test Conditions: I _d = 50 mA, Z _O = 50 Ω	Units	Min.	Typ.	Max.
G _P	Power Gain (S ₂₁ ²)	f = 0.1 GHz	7.5	8.5	9.5
ΔG _P	Gain Flatness	f = 0.1 to 2.5 GHz		±0.6	±1.0
f _{3 dB}	3 dB Bandwidth			3.8	
VSWR	Input VSWR	f = 0.1 to 2.5 GHz		1.4:1	
	Output VSWR	f = 0.1 to 2.5 GHz		1.9:1	
P _{1 dB}	Output Power @ 1 dB Gain Compression	f = 1.0 GHz		12.5	
NF	50 Ω Noise Figure	f = 1.0 GHz		6.5	
IP ₃	Third Order Intercept Point	f = 1.0 GHz		25.5	
t _D	Group Delay	f = 1.0 GHz		125	
V _d	Device Voltage		4.75	5.25	5.75
dV/dT	Device Voltage Temperature Coefficient			-8.0	

Notes: 1. Short leaded 36 package available upon request.
 2. The recommended operating current range for this device is 30 mA to 70 mA. Typical performance as a function of current is on the following page.

MSA-0435 MODAMP™ Cascadable Silicon Bipolar Monolithic Microwave Integrated Circuit Amplifiers

Absolute Maximum Ratings

Parameter	Absolute Maximum ¹
Device Current	100 mA
Power Dissipation ^{2,3}	650 mW
RF Input Power	+20 dBm
Junction Temperature	200°C
Storage Temperature ⁴	-65°C to 200°C

Thermal Resistance^{2,5}: $\theta_{jc} = 140^\circ\text{C/W}$

Notes:

- Permanent damage may occur if any of these limits are exceeded.
- T_{case} = 25°C
- Derate at 7.1 mW/°C for T_c > 109°C.
- Storage above +150°C may tarnish the leads of this package making it difficult to solder into a circuit.
- The small spot size of this technique results in a higher, though more accurate determination of θ_{jc} than do alternate methods. See MEASUREMENTS section "Thermal Resistance" for more information.

Typical Performance, T_A = 25°C

(unless otherwise noted)

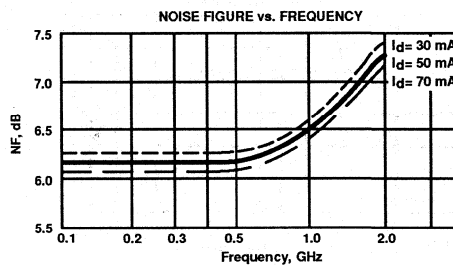
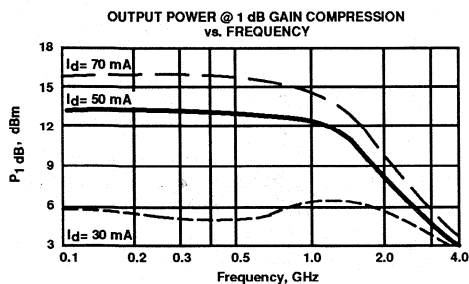
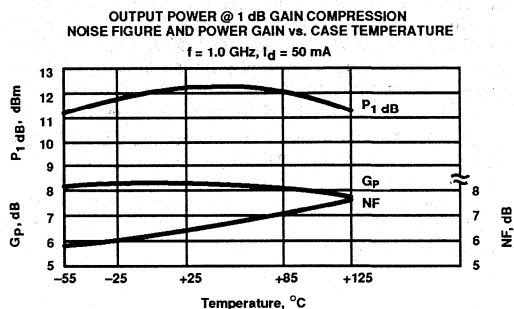
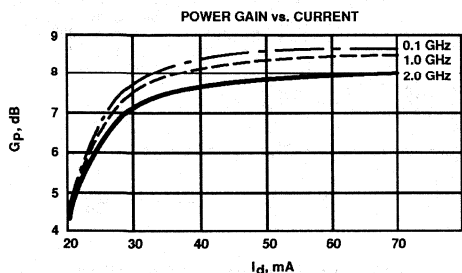
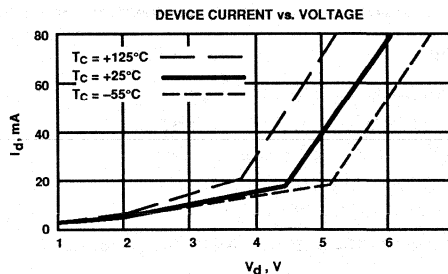

Typical Scattering Parameters: Z₀ = 50 Ω

T_A = 25°C, I_d = 50 mA

Freq. GHz	S ₁₁		S ₂₁		S ₁₂			S ₂₂		
	Mag	Ang	dB	Mag	dB	Mag	Ang	Mag	Ang	
0.1	.08	175	8.5	2.67	175	-16.4	.151	1	.20	-10
0.2	.08	172	8.5	2.68	170	-16.3	.153	2	.20	-16
0.4	.07	171	8.5	2.67	161	-16.4	.151	3	.20	-33
0.6	.07	166	8.5	2.66	151	-16.2	.155	6	.21	-45
0.8	.05	169	8.4	2.64	142	-16.1	.156	8	.22	-57
1.0	.05	175	8.3	2.61	136	-16.0	.159	10	.24	-68
1.5	.04	-142	8.1	2.55	109	-15.0	.178	13	.26	-96
2.0	.09	-145	7.8	2.46	87	-14.2	.196	15	.28	-123
2.5	.14	-154	7.3	2.33	71	-13.1	.221	18	.31	-140
3.0	.22	-175	6.6	2.14	50	-12.5	.238	14	.33	-160
3.5	.28	170	5.8	1.94	32	-11.7	.260	9	.35	-173
4.0	.34	156	4.8	1.74	15	-11.3	.271	4	.34	-179
4.5	.37	140	3.9	1.57	-1	-10.7	.291	-2	.33	-171
5.0	.42	120	3.0	1.41	-16	-10.4	.302	-8	.32	-160

A model for this device is available in the DEVICE MODELS section.

Features

- Cascadable 50 Ω Gain Block
- 3 dB Bandwidth: DC to 4.0 GHz
- 12.5 dBm typical P_{1 dB} at 1.0 GHz
- 8.5 dB typical Gain at 1.0 GHz
- Unconditionally Stable (k>1)
- Hermetic Gold-ceramic Microstrip Package

Description

Avantek's MSA-0470 is a high performance silicon bipolar Monolithic Microwave Integrated Circuit (MMIC) housed in a hermetic high reliability package. This MODAMP™ MMIC is designed for use as a general purpose 50 Ω gain block. Typical applications include narrow and broad band IF and RF amplifiers in industrial and military applications.

The MODAMP MSA-series is fabricated using a 10 GHz f_r, 25 GHz f_{MAX} silicon bipolar MMIC process which utilizes nitride self-alignment, ion implantation and gold metallization to achieve excellent uniformity, performance, and reliability. The use of an external bias resistor for temperature and current stability also allows bias flexibility.

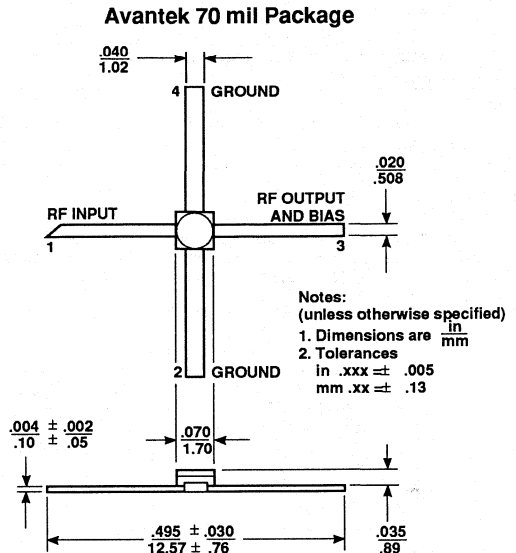

TYPICAL POWER GAIN vs. FREQUENCY
T_A = 25°C, I_d = 50 mA

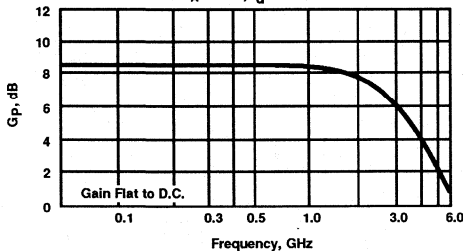

Typical Biasing Configuration

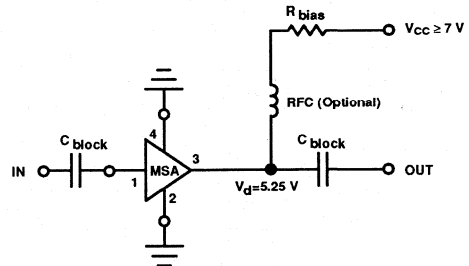

Electrical Specifications¹, T_A = 25°C

Symbol	Parameters and Test Conditions: I _d = 50 mA, Z ₀ = 50 Ω	Units	Min.	Typ.	Max.
G _p	Power Gain (S ₂₁ ²) f = 0.1 GHz	dB	7.5	8.5	9.5
ΔG _p	Gain Flatness f = 0.1 to 2.5 GHz	dB		±0.6	±1.0
f _{3 dB}	3 dB Bandwidth	GHz		4.0	
VSWR	Input VSWR f = 0.1 to 2.5 GHz			1.7:1	
	Output VSWR f = 0.1 to 2.5 GHz			2.0:1	
P _{1 dB}	Output Power @ 1 dB Gain Compression f = 1.0 GHz	dBm		12.5	
NF	50 Ω Noise Figure f = 1.0 GHz	dB		6.5	
IP ₃	Third Order Intercept Point f = 1.0 GHz	dBm		25.5	
t _d	Group Delay f = 1.0 GHz	psec.		125	
V _d	Device Voltage	V	4.75	5.25	5.75
dV/dT	Device Voltage Temperature Coefficient	mV/°C		-8.0	

Note: 1. The recommended operating current range for this device is 30 mA to 70 mA. Typical performance as a function of current is on the following page.

MSA-0470 MODAMP™ Cascadable Silicon Bipolar Monolithic Microwave Integrated Circuit Amplifiers

Absolute Maximum Ratings

Parameter	Absolute Maximum ¹
Device Current	100 mA
Power Dissipation ^{2,3}	650 mW
RF Input Power	+20 dBm
Junction Temperature	200°C
Storage Temperature	-65°C to 200°C

Thermal Resistance^{2,4}: $\theta_{JC} = 115^\circ\text{C/W}$

Notes:

- Permanent damage may occur if any of these limits are exceeded.
- TCASE = 25°C
- Derate at 8.7 mW/°C for $T_C > 125^\circ\text{C}$.
- The small spot size of this technique results in a higher, though more accurate determination of θ_{JC} than do alternate methods. See MEASUREMENTS section "Thermal Resistance" for more information.

Typical Performance, $T_A = 25^\circ\text{C}$

(unless otherwise noted)

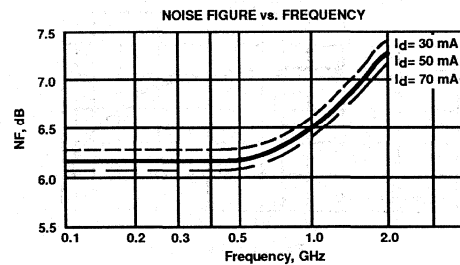
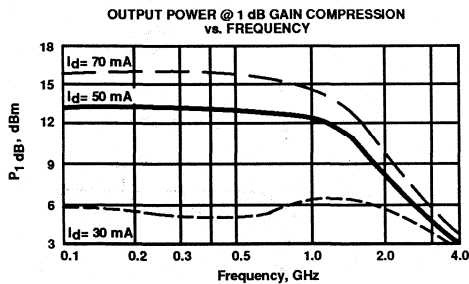
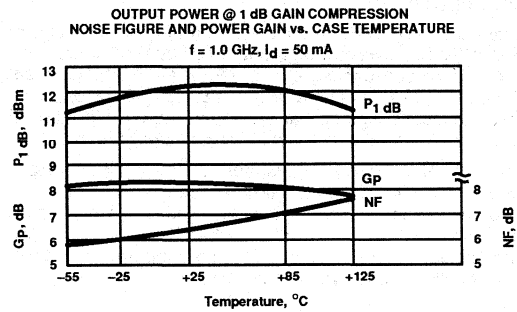
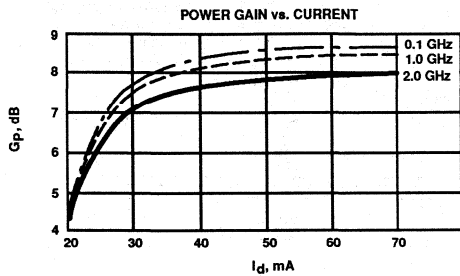
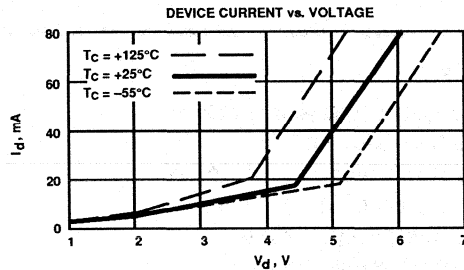

Typical Scattering Parameters: $Z_0 = 50 \Omega$

$T_A = 25^\circ\text{C}, I_d = 50 \text{ mA}$

Freq. GHz	S_{11}		S_{21}			S_{12}			S_{22}	
	Mag	Ang	dB	Mag	Ang	dB	Mag	Ang	Mag	Ang
0.1	.18	179	8.5	2.67	176	-16.4	.151	1	.10	-14
0.2	.18	179	8.5	2.67	172	-16.4	.151	2	.10	-30
0.4	.18	179	8.5	2.67	163	-16.4	.152	3	.13	-50
0.6	.17	-179	8.5	2.65	155	-16.2	.155	5	.16	-67
0.8	.16	-176	8.4	2.64	147	-16.1	.158	6	.19	-79
1.0	.16	-174	8.3	2.61	138	-15.9	.161	6	.22	-90
1.5	.16	-166	8.2	2.56	117	-15.5	.169	9	.29	-111
2.0	.21	-163	7.8	2.46	97	-14.6	.186	9	.33	-131
2.5	.26	-162	7.3	2.33	83	-13.8	.204	12	.36	-142
3.0	.32	-170	6.5	2.12	65	-13.5	.212	10	.40	-156
3.5	.37	-177	5.7	1.93	38	-13.2	.220	7	.40	-164
4.0	.40	175	4.7	1.73	33	-12.6	.234	3	.40	-170
4.5	.41	166	3.9	1.57	20	-12.4	.239	-1	.39	-173
5.0	.42	155	3.1	1.44	7	-11.9	.255	-6	.37	-176

A model for this device is available in the DEVICE MODELS section.

Features

- Cascadable 50 Ω Gain Block
- 3 dB Bandwidth: DC to 3.6 GHz
- 12.5 dBm typical P_{1 dB} at 1.0 GHz
- 8 dB typical Gain at 1.0 GHz
- Unconditionally Stable (k>1)
- Low Cost Plastic Package

Description

Avantek's MSA-0485 is a high performance silicon bipolar Monolithic Microwave Integrated Circuit (MMIC) housed in a low cost plastic package. This MODAMP™ MMIC is designed for use as a general purpose 50 Ω gain block. Typical applications include narrow and broad band IF and RF amplifiers in commercial and industrial applications.

The MODAMP MSA-series is fabricated using a 10 GHz f_r, 25 GHz f_{MAX} silicon bipolar MMIC process which utilizes nitride self-alignment, ion implantation and gold metallization to achieve excellent uniformity, performance, and reliability. The use of an external bias resistor for temperature and current stability also allows bias flexibility.

Avantek 85 Plastic Package

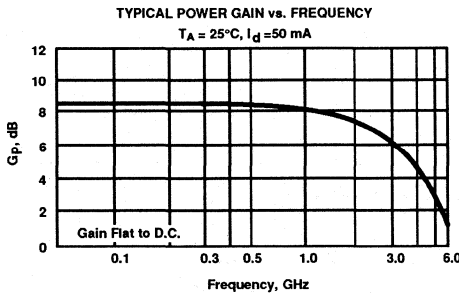
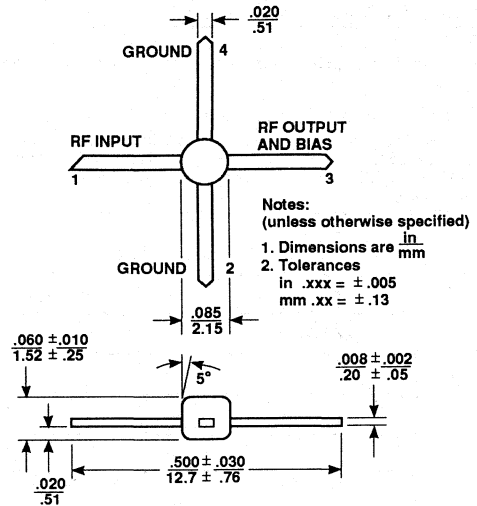

Typical Biasing Configuration

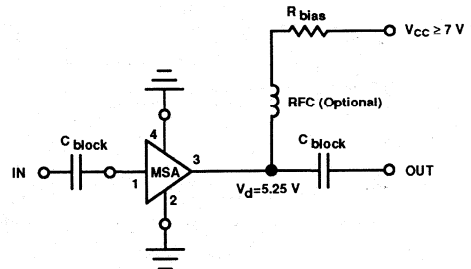

Electrical Specifications¹, T_A = 25°C

Symbol	Parameters and Test Conditions: I _d = 50 mA, Z _O = 50 Ω	Units	Min.	Typ.	Max.
G _p	Power Gain (S ₂₁ ²) f = 0.1 GHz f = 1.0 GHz	dB	7.0	8.3 8.0	
ΔG _p	Gain Flatness f = 0.1 to 2.5 GHz	dB		±0.7	
f _{3 dB}	3 dB Bandwidth	GHz		3.6	
VSWR	Input VSWR f = 0.1 to 2.5 GHz			1.6:1	
	Output VSWR f = 0.1 to 2.5 GHz			2.0:1	
P _{1 dB}	Output Power @ 1 dB Gain Compression f = 1.0 GHz	dBm		12.5	
NF	50 Ω Noise Figure f = 1.0 GHz	dB		7.0	
IP ₃	Third Order Intercept Point f = 1.0 GHz	dBm		25.5	
t _p	Group Delay f = 1.0 GHz	psec.		125	
V _d	Device Voltage	V	4.2	5.25	6.3
dV/dT	Device Voltage Temperature Coefficient	mV/°C		-8.0	

Note: 1. The recommended operating current range for this device is 30 mA to 70 mA. Typical performance as a function of current is on the following page.

MSA-0485 MODAMPT™ Cascadable Silicon Bipolar Monolithic Microwave Integrated Circuit Amplifiers

Absolute Maximum Ratings

Parameter	Absolute Maximum ¹
Device Current	85 mA
Power Dissipation ^{2,3}	500 mW
RF Input Power	+20 dBm
Junction Temperature	150°C
Storage Temperature	-65°C to 150°C

Thermal Resistance^{2,4}: $\theta_{jC} = 90^\circ\text{C/W}$

Notes:

- Permanent damage may occur if any of these limits are exceeded.
- TCASE = 25°C
- Derate at 11.1 mW/°C for TC > 105°C.
- See MEASUREMENTS section "Thermal Resistance" for more information.

Typical Performance, T_A = 25°C

(unless otherwise noted)

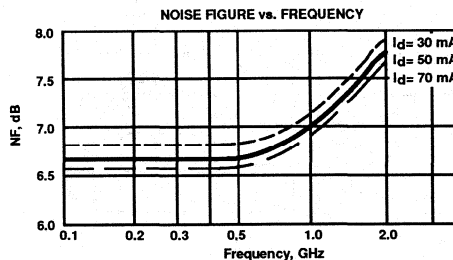
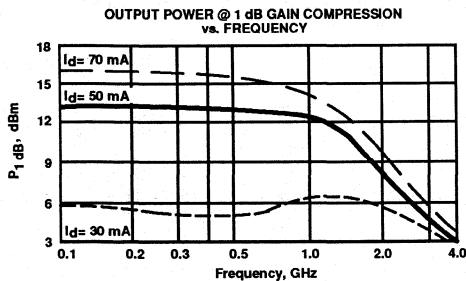
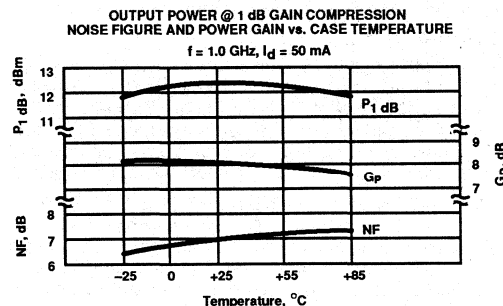
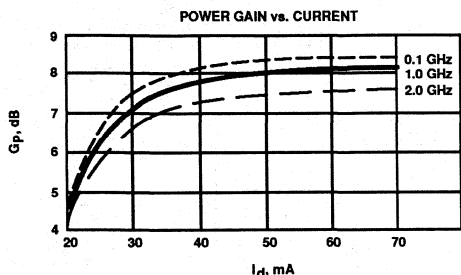
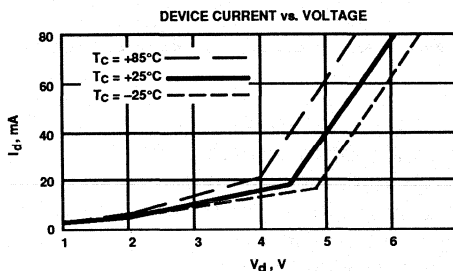

Typical Scattering Parameters: Z₀ = 50 Ω

T_A = 25°C, I_d = 50 mA

Freq. GHz	S ₁₁		S ₂₁			S ₁₂			S ₂₂	
	Mag	Ang	dB	Mag	Ang	dB	Mag	Ang	Mag	Ang
0.1	.21	177	8.4	2.63	175	-16.1	.156	2	.08	-16
0.2	.20	176	8.3	2.60	171	-16.2	.155	2	.08	-30
0.4	.20	172	8.2	2.57	163	-16.1	.156	3	.10	-54
0.6	.19	171	8.1	2.55	155	-16.2	.155	5	.13	-71
0.8	.19	168	8.1	2.54	146	-16.0	.158	6	.16	-83
1.0	.18	166	8.0	2.52	138	-15.7	.164	9	.18	-93
1.5	.16	167	7.8	2.46	117	-15.3	.171	11	.25	-116
2.0	.18	168	7.4	2.34	97	-14.6	.187	12	.29	-135
2.5	.21	173	6.9	2.21	83	-13.8	.204	16	.34	-150
3.0	.27	169	6.3	2.07	65	-13.4	.213	13	.38	-161
3.5	.33	161	5.7	1.92	48	-12.6	.234	9	.39	-172
4.0	.38	154	4.8	1.74	33	-12.3	.242	6	.37	-179
4.5	.42	145	4.1	1.59	18	-12.1	.249	3	.36	-174
5.0	.44	131	3.3	1.46	4	-11.7	.259	-3	.34	-165

A model for this device is available in the DEVICE MODELS section.

Features

- Cascadable 50 Ω Gain Block
- 3 dB Bandwidth: DC to 3.2 GHz
- 12.5 dBm typical P_{1dB} at 1.0 GHz
- 8 dB typical Gain at 1.0 GHz
- Unconditionally Stable (k>1)
- Surface Mount Plastic Package
- Tape-and-Reel Packaging Option Available¹

Description

Avantek's MSA-0486 is a high performance silicon bipolar Monolithic Microwave Integrated Circuit (MMIC) housed in a low cost, surface mount plastic package. This MODAMP™ MMIC is designed for use as a general purpose 50 Ω gain block. Applications include narrow and broad band IF and RF amplifiers in commercial and industrial applications.

The MODAMP MSA-series is fabricated using a 10 GHz f_T, 25 GHz f_{MAX} silicon bipolar MMIC process which utilizes nitride self-alignment, ion implantation and gold metallization to achieve excellent uniformity, performance, and reliability. The use of an external bias resistor for temperature and current stability also allows bias flexibility.

Avantek 86 Plastic Package

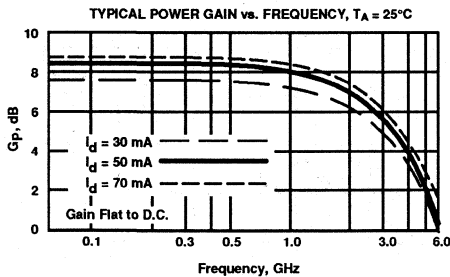
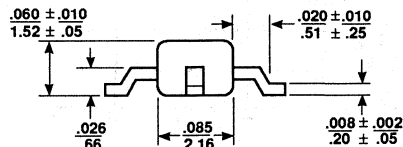
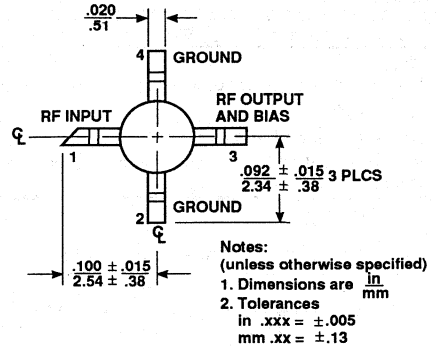

Typical Biasing Configuration

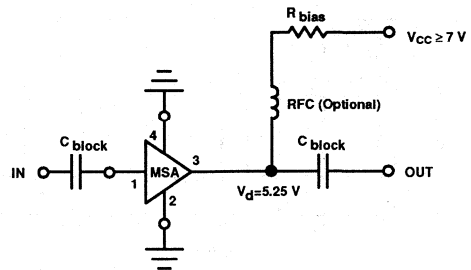

Electrical Specifications², T_A = 25°C

Symbol	Parameters and Test Conditions: I _d = 50 mA, Z _O = 50 Ω	Units	Min.	Typ.	Max.
G _P	Power Gain (S ₂₁ ²) f = 0.1 GHz f = 1.0 GHz	dB	7.0	8.3 8.0	
ΔG _P	Gain Flatness f = 0.1 to 2.0 GHz	dB		±0.6	
f _{3 dB}	3 dB Bandwidth	GHz		3.2	
VSWR	Input VSWR f = 0.1 to 2.0 GHz			1.5:1	
	Output VSWR f = 0.1 to 2.0 GHz			1.9:1	
P _{1 dB}	Output Power @ 1 dB Gain Compression f = 1.0 GHz	dBm		12.5	
NF	50 Ω Noise Figure f = 1.0 GHz	dB		7.0	
IP ₃	Third Order Intercept Point f = 1.0 GHz	dBm		25.5	
t _d	Group Delay f = 1.0 GHz	psec.		140	
V _d	Device Voltage	V	4.2	5.25	6.3
dV/dT	Device Voltage Temperature Coefficient	mV/°C		-8.0	

Notes: 1. Refer to PACKAGING section "Tape-and-Reel Packaging for Surface Mount Semiconductors".
 2. The recommended operating current range for this device is 30 mA to 70 mA. Typical performance as a function of current is on the following page.

MSA-0486 MODAMP™ Cascadable Silicon Bipolar Monolithic Microwave Integrated Circuit Amplifiers

Absolute Maximum Ratings

Parameter	Absolute Maximum ¹
Device Current	85 mA
Power Dissipation ^{2,3}	500 mW
RF Input Power	+20 dBm
Junction Temperature	150°C
Storage Temperature	-65°C to 150°C

Thermal Resistance^{2,4}: $\theta_{JC} = 100^\circ\text{C/W}$

Notes:

1. Permanent damage may occur if any of these limits are exceeded.
2. TCASE = 25°C
3. Derate at 10 mW/°C for TC > 100°C.
4. See MEASUREMENTS section "Thermal Resistance" for more information.

Part Number Ordering Information

Part Number	Devices Per Reel	Reel Size
MSA-0486-TR1	1000	7"
MSA-0486-TR2	4000	13"

Typical Performance, T_A = 25°C (unless otherwise noted)

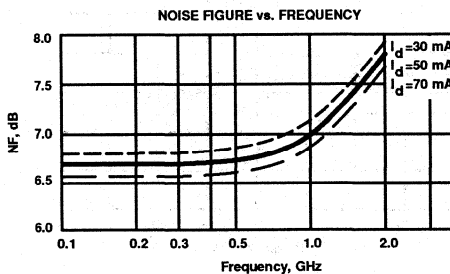
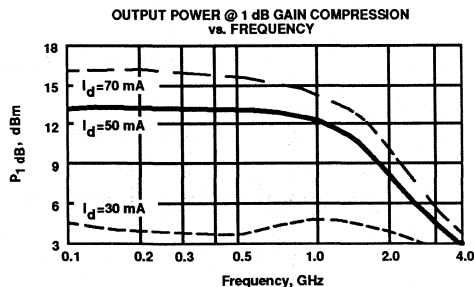
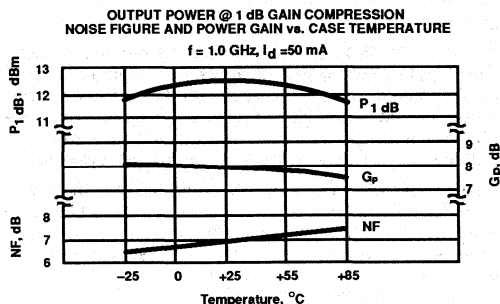
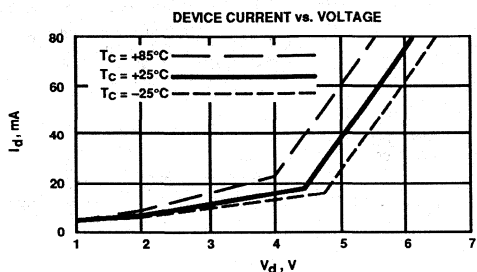

Typical Scattering Parameters: Z₀ = 50 Ω

T_A = 25°C, I_d = 50 mA

Freq. GHz	S ₁₁		S ₂₁			S ₁₂			S ₂₂	
	Mag	Ang	dB	Mag	Ang	dB	Mag	Ang	Mag	Ang
0.1	.14	178	8.4	2.62	175	-16.2	.154	1	.16	-10
0.2	.14	175	8.3	2.61	170	-16.3	.153	2	.16	-20
0.4	.14	171	8.2	2.57	161	-16.3	.154	3	.17	-39
0.6	.13	168	8.1	2.54	151	-16.0	.158	4	.18	-57
0.8	.13	166	8.0	2.52	141	-15.9	.161	5	.20	-74
1.0	.13	165	7.9	2.48	131	-15.7	.165	6	.21	-88
1.5	.15	168	7.7	2.42	108	-14.8	.182	8	.27	-121
2.0	.21	168	7.3	2.32	84	-14.0	.199	7	.32	-149
2.5	.29	165	6.8	2.18	65	-13.1	.222	4	.38	-168
3.0	.37	153	5.9	1.97	43	-12.7	.231	-1	.40	173
3.5	.44	142	4.8	1.74	24	-12.5	.238	-5	.41	157
4.0	.50	130	3.6	1.52	7	-12.5	.238	-10	.41	145
5.0	.61	109	1.3	1.16	-21	-12.7	.231	-17	.43	132

A model for this device is available in the DEVICE MODELS section.

Features

- Cascadable 50 Ω Gain Block
- High Output Power:
18.0 dBm typical $P_{1\text{ dB}}$ at 1.0 GHz
- Low Distortion:
29.0 dBm typical IP_3 at 1.0 GHz
- 7.0 dB typical Gain at 1.0 GHz
- Low Cost Plastic Package

Description

Avantek's MSA-0504 is a high performance medium power silicon bipolar Monolithic Microwave Integrated Circuit (MMIC) housed in a low cost plastic package. This MODAMP™ MMIC is designed for use as a general purpose 50 Ω gain block. Typical applications include narrow and broadband IF and RF amplifiers in commercial systems.

The MODAMP MSA-series is fabricated using a 10 GHz f_T , 25 GHz f_{MAX} silicon bipolar MMIC process which utilizes nitride self-alignment, ion implantation and gold metallization to achieve excellent performance, uniformity, and reliability. The use of an external bias resistor for temperature and current stability also allows bias flexibility.

Avantek 04 Plastic Package

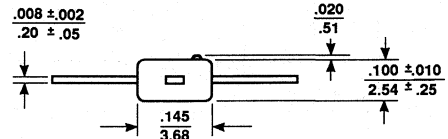
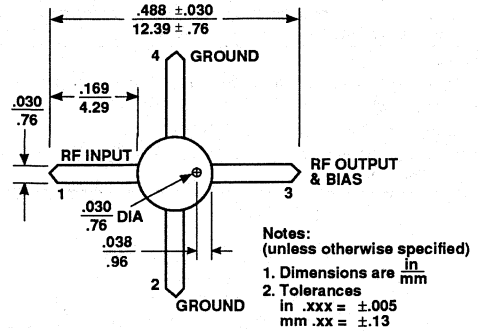

TYPICAL GAIN vs. POWER OUT
 $T_A = 25^\circ\text{C}$, $I_d = 80\text{ mA}$

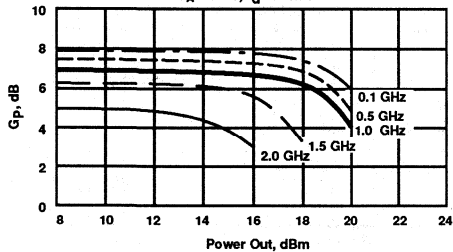

Typical Biasing Configuration

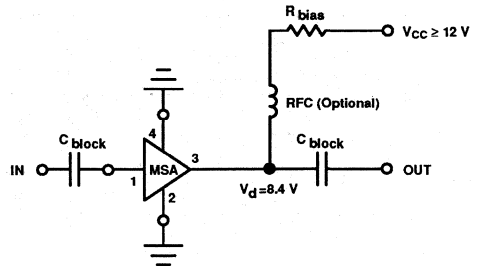

Electrical Specifications¹, $T_A = 25^\circ\text{C}$

Symbol	Parameters and Test Conditions: $I_d = 80\text{ mA}$, $Z_O = 50\ \Omega$	Units	Min.	Typ.	Max.
$P_{1\text{ dB}}$	Output Power @ 1 dB Gain Compression $f = 0.5\text{ GHz}$ $f = 1.0\text{ GHz}$	dBm dBm	16.0	19.0 18.0	
G_p	Power Gain ($ S_{21} ^2$) $f = 0.5\text{ GHz}$ $f = 1.0\text{ GHz}$	dB dB	6.0	7.5 7.0	
ΔG_p	Gain Flatness $f = 0.1\text{ to }1.5\text{ GHz}$	dB		±0.75	
$f_3\text{ dB}$	3 dB Bandwidth ²	GHz		2.3	
VSWR	Input VSWR $f = 0.1\text{ to }1.5\text{ GHz}$			1.6:1	
	Output VSWR $f = 0.1\text{ to }1.5\text{ GHz}$			2.0:1	
IP_3	Third Order Intercept Point $f = 1.0\text{ GHz}$	dBm		29.0	
NF	50 Ω Noise Figure $f = 1.0\text{ GHz}$	dB		6.5	
t_D	Group Delay $f = 1.0\text{ GHz}$	psec.		180	
V_d	Device Voltage	V	6.7	8.4	10.1
dV/dT	Device Voltage Temperature Coefficient	mV/°C		-16.0	

Notes: 1. The recommended operating current range for this device is 60 mA to 100 mA. Typical performance as a function of current is on the following page.
2. Referenced from 0.1 GHz Gain (G_p).

MSA-0504 MODAMP™ Cascadable Silicon Bipolar Monolithic Microwave Integrated Circuit Amplifiers

Absolute Maximum Ratings

Parameter	Absolute Maximum ¹
Device Current	135 mA
Power Dissipation ^{2,3}	1.5 W
RF Input Power	+25 dBm
Junction Temperature	200°C
Storage Temperature	-65°C to 150°C

Thermal Resistance^{2,4}: $\theta_{jC} = 75^\circ\text{C}/\text{W}$

Notes:

1. Permanent damage may occur if any of these limits are exceeded.
2. T_{case} = 25°C
3. Derate at 13.3 mW/°C for T_C > 88°C.
4. See MEASUREMENTS section "Thermal Resistance" for more information.

Typical Performance, T_A = 25°C

(unless otherwise noted)

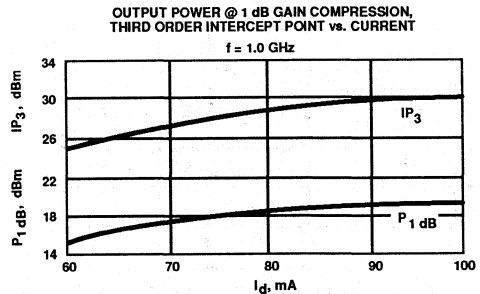
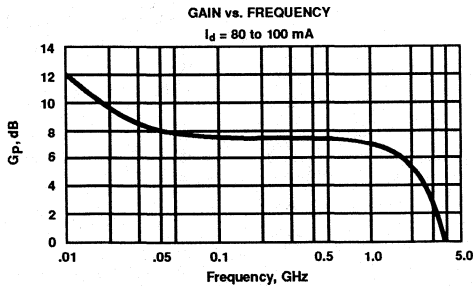
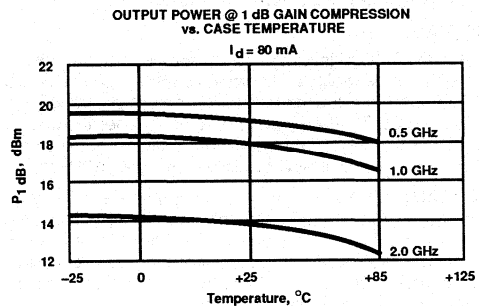
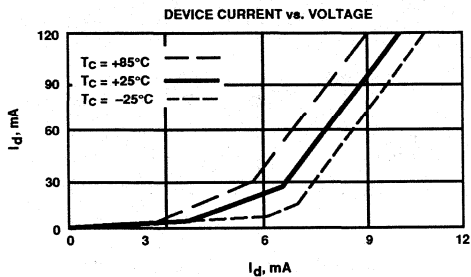
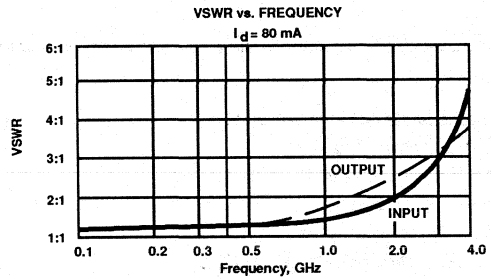

Typical Scattering Parameters

T_A = 25°C, I_d = 80 mA

Freq. MHz	S ₁₁		S ₂₁			S ₁₂			S ₂₂		k
	Mag	Ang	dB	Mag	Ang	dB	Mag	Ang	Mag	Ang	
5	.54	-43	14.7	5.43	160	-18.4	.120	37	.63	-39	0.60
25	.24	-112	9.3	2.92	155	-13.8	.204	12	.24	-101	0.99
50	.18	-142	8.1	2.54	161	-13.7	.206	3	.16	-125	1.17
100	.14	-156	7.8	2.45	166	-13.7	.207	3	.13	-137	1.18
200	.14	-168	7.6	2.40	163	-13.7	.206	1	.13	-146	1.20
400	.14	-174	7.5	2.37	150	-13.7	.206	1	.16	-143	1.19
600	.14	-175	7.4	2.34	137	-13.6	.208	-1	.20	-144	1.18
800	.15	-174	7.2	2.29	124	-13.5	.211	-1	.25	-148	1.15
1000	.17	-174	7.0	2.24	111	-13.6	.209	-3	.29	-154	1.14
1500	.23	-179	6.4	2.09	80	-13.3	.216	-4	.37	-168	1.06
2000	.33	-171	5.5	1.88	51	-12.8	.230	-10	.48	-178	0.91
2500	.42	-156	4.3	1.64	27	-13.0	.224	-12	.51	-165	0.90
3000	.49	-146	3.2	1.44	6	-12.8	.230	-11	.55	-157	0.92

A model for this device is available in the DEVICE MODELS section.

Features

- Cascadable 50 Ω Gain Block
- High Output Power:
18.0 dBm typical P_{1dB} at 1.0 GHz
- Low Distortion:
29.0 dBm typical IP₃ at 1.0 GHz
- 7.0 dB typical Gain at 1.0 GHz
- Surface Mount Plastic Package
- Tape-and-Reel Packaging Option Available¹

Description

Avantek's MSA-0505 is a high performance medium power silicon bipolar Monolithic Microwave Integrated Circuit (MMIC) housed in a low cost, surface mount package. This MODAMP™ MMIC is designed for use as a general purpose 50 Ω gain block. Typical applications include narrow and broadband IF and RF amplifiers in commercial systems.

The MODAMP MSA-series is fabricated using a 10 GHz f_r, 25 GHz f_{MAX} silicon bipolar MMIC process which utilizes nitride self-alignment, ion implantation and gold metallization to achieve excellent performance, uniformity, and reliability. The use of an external bias resistor for temperature and current stability also allows bias flexibility.

Avantek 05 Plastic Package

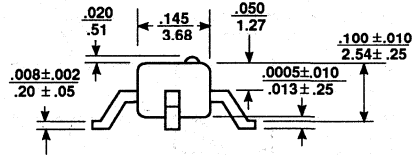
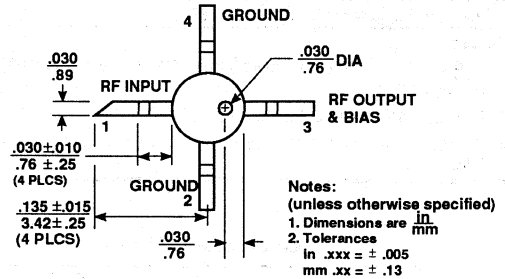

Typical Biasing Configuration

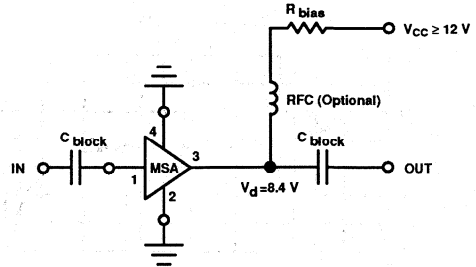

TYPICAL GAIN vs. POWER OUT
 T_A = 25°C, I_d = 80 mA

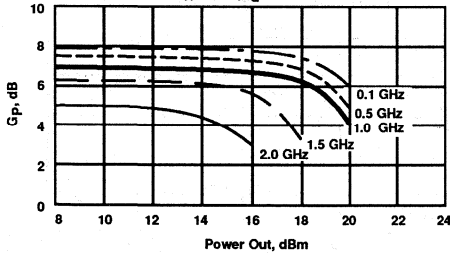

Electrical Specifications², T_A = 25°C

Symbol	Parameters and Test Conditions: I _d = 80 mA, Z _O = 50 Ω	Units	Min.	Typ.	Max.
P _{1dB}	Output Power @ 1 dB Gain Compression f = 0.5 GHz f = 1.0 GHz	dBm dBm	16.0	19.0 18.0	
G _p	Power Gain (S ₂₁ ²) f = 0.5 GHz f = 1.0 GHz	dB dB	6.0	7.5 7.0	
ΔG _p	Gain Flatness f = 0.1 to 1.5 GHz	dB		±0.75	
f _{3dB}	3 dB Bandwidth ³	GHz		2.3	
VSWR	Input VSWR f = 0.1 to 1.5 GHz			1.6:1	
	Output VSWR f = 0.1 to 1.5 GHz			2.0:1	
IP ₃	Third Order Intercept Point f = 1.0 GHz	dBm		29.0	
NF	50 Ω Noise Figure f = 1.0 GHz	dB		6.5	
t _d	Group Delay f = 1.0 GHz	psec		190	
V _d	Device Voltage	V	6.7	8.4	10.1
dV/dT	Device Voltage Temperature Coefficient	mV/°C		-16.0	

Notes: 1. Refer to PACKAGING section "Tape-and-Reel Packaging for Surface Mount Semiconductors".
 2. The recommended operating current range for this device is 60 mA to 100 mA. Typical performance as a function of current is on the following page.
 3. Referenced from 0.1 GHz Gain (G_p).

MSA-0505 MODAMP™ Cascadable Silicon Bipolar Monolithic Microwave Integrated Circuit Amplifiers

Absolute Maximum Ratings

Parameter	Absolute Maximum ¹
Device Current	135 mA
Power Dissipation ^{2,3}	1.5 W
RF Input Power	+25 dBm
Junction Temperature	200°C
Storage Temperature	-65°C to 150°C

Thermal Resistance^{2,4}: $\theta_{jC} = 85^\circ\text{C/W}$

Notes:

- Permanent damage may occur if any of these limits are exceeded.
- $T_{\text{CASE}} = 25^\circ\text{C}$
- Derate at 11.8 mW/°C for $T_C > 73^\circ\text{C}$.
- See MEASUREMENTS section "Thermal Resistance" for more information.

Part Number Ordering Information

Part Number	Devices Per Reel	Reel Size
MSA-0505-TR1	500	7"
MSA-0505-TR2	1500	13"

Typical Performance, $T_A = 25^\circ\text{C}$

(unless otherwise noted)

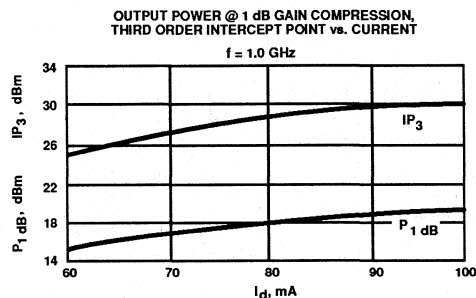
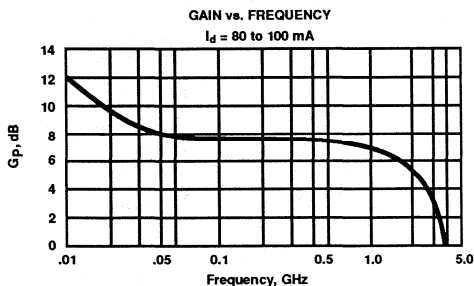
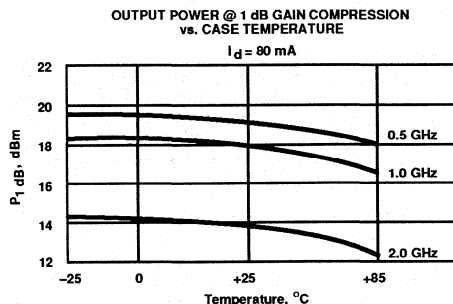
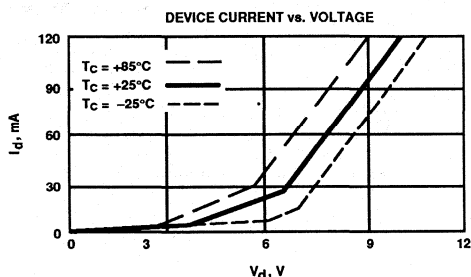

Typical Scattering Parameters

$T_A = 25^\circ\text{C}, I_d = 80 \text{ mA}$

Freq. MHz	S11		S21		S12		S22		k		
	Mag	Ang	dB	Mag	Ang	dB	Mag	Ang			
5	.56	-39	14.9	5.56	161	-18.5	.120	39	.65	-36	0.60
25	.24	-103	9.7	3.05	156	-13.9	.202	12	.25	-90	0.97
50	.15	-130	8.2	2.57	163	-13.7	.207	7	.15	-116	1.15
100	.13	-155	7.8	2.45	165	-13.7	.207	3	.11	-132	1.21
200	.12	-170	7.7	3.43	161	-13.5	.211	1	.11	-145	1.21
400	.12	178	7.5	2.37	148	-13.6	.209	-1	.14	-146	1.23
600	.13	172	7.4	2.34	134	-13.6	.209	-2	.17	-151	1.23
800	.13	168	7.2	2.29	119	-13.6	.209	-3	.21	-157	1.23
1000	.14	166	7.0	2.24	105	-13.4	.213	-4	.25	-164	1.21
1500	.21	159	6.4	2.09	72	-13.3	.217	-6	.34	176	1.16
2000	.30	148	5.2	1.82	42	-13.1	.222	-9	.42	159	1.12
2500	.40	136	4.1	1.60	17	-12.9	.227	-11	.48	146	1.05
3000	.52	121	2.7	1.36	-7	-12.6	.234	-16	.55	133	0.92

A model for this device is available in the DEVICE MODELS section.

Features

- **Cascadable 50 Ω Gain Block**
- **High Output Power:**
 +23 dBm typical $P_{1\text{ dB}}$ at 1.0 GHz
- **Low Distortion:**
 33 dBm typical IP_3 at 1.0 GHz
- **8.5 dB typical Gain at 1.0 GHz**
- **Hermetic, Metal/Beryllia Microstrip Package**

Description

Avantek's MSA-0520 is a high performance, medium power silicon bipolar Monolithic Microwave Integrated Circuit (MMIC) housed in a hermetic, BeO disk package for good thermal characteristics. This MODAMP™ MMIC is designed for use as a general purpose 50 Ω gain block. Typical applications include narrow and broad band IF and RF amplifiers in industrial and military systems.

The MODAMP MSA-series is fabricated using a 10 GHz f_T , 25 GHz f_{MAX} silicon bipolar MMIC process which utilizes nitride self-alignment, ion implantation and gold metallization to achieve excellent uniformity, performance, and reliability. The use of an external bias resistor for temperature and current stability also allows bias flexibility.

Avantek 200 mil BeO Package

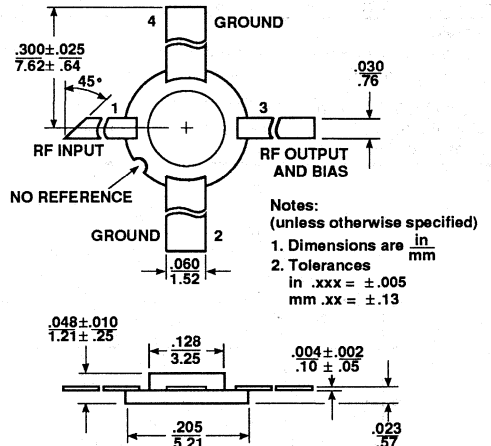

TYPICAL GAIN vs. POWER OUT
 $T_A = 25^\circ\text{C}, I_d = 165\text{ mA}$

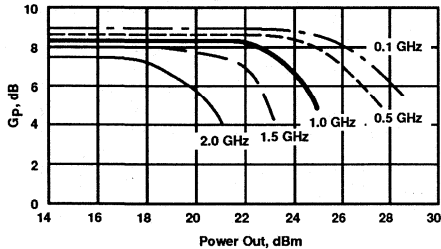

Typical Biasing Configuration

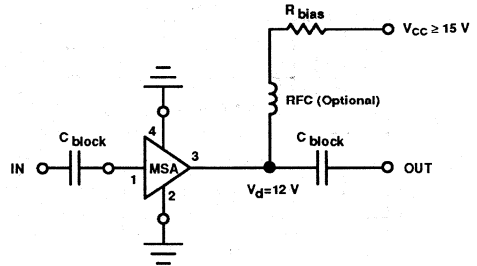

Electrical Specifications¹, $T_A = 25^\circ\text{C}$

Symbol	Parameters and Test Conditions: $I_d = 165\text{ mA}, Z_0 = 50\ \Omega$	Units	Min.	Typ.	Max.
$P_{1\text{ dB}}$	Output Power @ 1 dB Gain Compression $f = 1.0\text{ GHz}$	dBm	21.0	23.0	
G_p	Power Gain ($ S_{21} ^2$) $f = 1.0\text{ GHz}$	dB	7.5	8.5	9.5
ΔG_p	Gain Flatness $f = 0.1\text{ to }2.0\text{ GHz}$	dB		±0.75	
$f_3\text{ dB}$	3 dB Bandwidth ²	GHz		2.8	
VSWR	Input VSWR $f = 0.1\text{ to }2.0\text{ GHz}$			2.0:1	
	Output VSWR $f = 0.1\text{ to }2.0\text{ GHz}$			2.5:1	
IP_3	Third Order Intercept Point $f = 1.0\text{ GHz}$	dBm		33.0	
$NF_{50\ \Omega}$	50 Ω Noise Figure $f = 1.0\text{ GHz}$	dB		6.5	
t_D	Group Delay $f = 1.0\text{ GHz}$	psec.		170	
V_d	Device Voltage	V	10.5	12.0	13.5
dV/dT	Device Voltage Temperature Coefficient	mV/°C		-16.0	

Notes: 1. The recommended operating current range for this device is 80 mA to 200 mA. Typical performance as a function of current is on the following page.
 2. Referenced from 0.1 GHz Gain (G_p).

MSA-0520 MODAMP™ Cascadable Silicon Bipolar Monolithic Microwave Integrated Circuit Amplifiers

Absolute Maximum Ratings

Parameter	Absolute Maximum ¹
Device Current	225 mA
Power Dissipation ^{2,3}	3.0 W
RF Input Power	+25 dBm
Junction Temperature	200°C
Storage Temperature	-65°C to 200°C

Thermal Resistance^{2,4}: $\theta_{jC} = 25^\circ\text{C/W}$

Notes:

- Permanent damage may occur if any of these limits are exceeded.
- T_{CASE} = 25°C
- Derate at 40 mW/°C for T_C > 125°C.
- The small spot size of this technique results in a higher, though more accurate determination of θ_{jC} than do alternate methods. See MEASUREMENTS section "Thermal Resistance" for more information.

Typical Performance, T_A = 25°C

(unless otherwise noted)

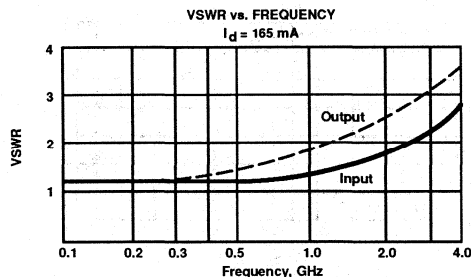
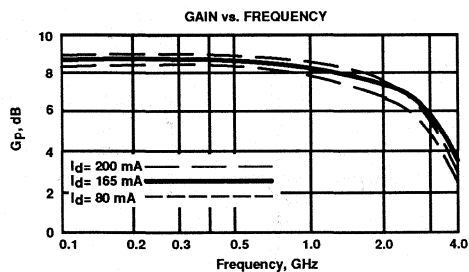
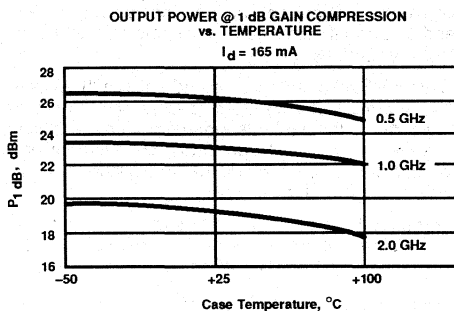
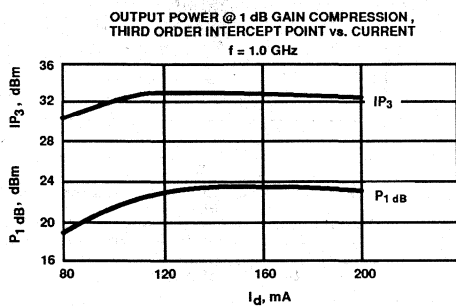
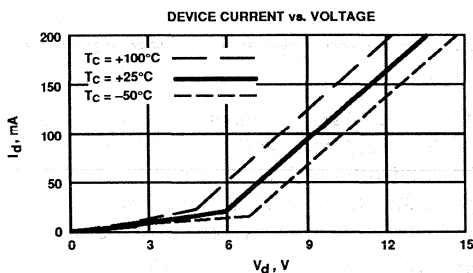

Typical Scattering Parameters

T_A = 25°C, I_d = 165 mA

Freq. MHz	S ₁₁		S ₂₁			S ₁₂			S ₂₂		k
	Mag	Ang	dB	Mag	Ang	dB	Mag	Ang	Mag	Ang	
5	.57	-38	14.4	5.25	165	-19.4	.107	38	.67	-35	0.57
25	.25	-90	10.7	3.42	160	-14.9	.180	17	.29	-81	.093
50	.15	-111	9.5	2.97	163	-14.4	.190	9	.18	-97	1.10
100	.11	-138	8.9	2.80	166	-14.2	.195	3	.11	-113	1.16
200	.10	-152	8.8	2.75	163	-14.1	.197	1	.10	-125	1.17
400	.10	-152	8.7	2.72	152	-14.1	.198	-2	.14	-123	1.16
600	.11	-147	8.6	2.70	140	-14.0	.199	-4	.18	-123	1.14
800	.13	-142	8.5	2.67	128	-14.1	.199	-6	.22	-127	1.12
1000	.15	-140	8.4	2.64	115	-14.1	.198	-8	.27	-131	1.09
1500	.22	-142	8.0	2.52	85	-13.7	.206	-12	.34	-143	0.98
2000	.30	-156	7.4	2.36	55	-13.3	.216	-16	.43	-158	0.85
2500	.37	-170	6.7	2.16	33	-12.9	.227	-18	.48	-166	0.75
3000	.41	170	5.6	1.91	8	-12.7	.232	-23	.51	-177	0.70
3500	.45	149	4.5	1.68	-16	-12.1	.249	-31	.55	173	0.63
4000	.46	124	3.3	1.45	-40	-11.7	.259	-39	.56	162	0.66

A model for this device is available in the DEVICE MODELS section.

Features

- Cascadable 50 Ω Gain Block
- Low Operating Voltage (3.5 V typical V_d)
- 3 dB Bandwidth: DC to 1.0 GHz
- High Gain: 19.5 dB typical at 0.5 GHz
- Low Noise Figure: 2.8 dB typical at 0.5 GHz

Description

Avantek's MSA-0600 is a high performance silicon bipolar Monolithic Microwave Integrated Circuit (MMIC) chip. This MODAMP™ MMIC is designed for use as a general purpose 50 Ω gain block. Typical applications include narrow and broad band IF and RF amplifiers in commercial, industrial and military applications.

The MODAMP MSA-series is fabricated using a 10 GHz f_T , 25 GHz f_{MAX} silicon bipolar MMIC process which utilizes nitride self-alignment, ion implantation and gold metallization to achieve excellent uniformity, performance, and reliability. The use of an external bias resistor for temperature and current stability also allows bias flexibility.

The recommended assembly procedure is gold-eutectic die attach at 400°C and either wedge or ball bonding using 0.7 mil gold wire. See APPLICATIONS section, "Chip Use".

Avantek Chip Outline¹

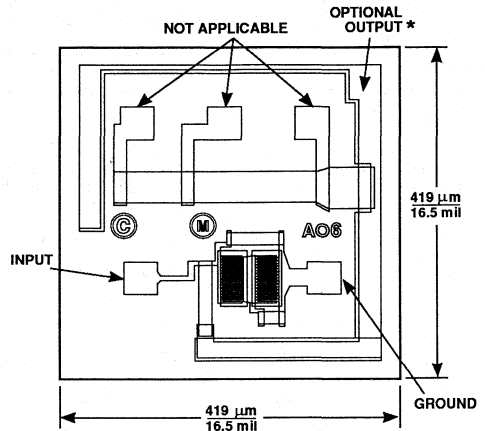

Unless otherwise specified, tolerances are $\pm 13 \mu\text{m} / \pm 0.5 \text{ mils}$.
 Chip thickness is $114 \mu\text{m} / 4.5 \text{ mil}$. Bond pads are $41 \mu\text{m} / 1.6 \text{ mil}$ typical on each side.
 * Output contact is made by die attaching the backside of the die.

TYPICAL POWER GAIN vs. FREQUENCY

$T_A = 25^\circ\text{C}$, $I_d = 16 \text{ mA}$

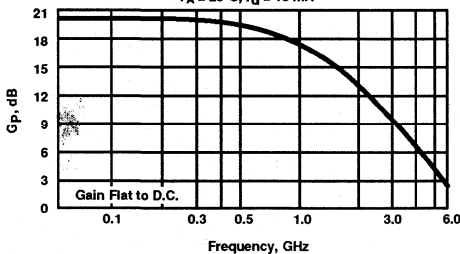

Typical Biasing Configuration

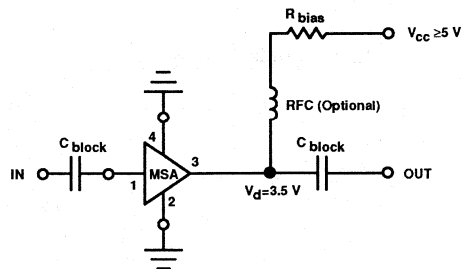

Electrical Specifications², $T_A = 25^\circ\text{C}$

Symbol	Parameters and Test Conditions ³ : $I_d = 16 \text{ mA}$, $Z_0 = 50 \Omega$	Units	Min.	Typ.	Max.
G_p	Power Gain ($ S_{21} ^2$)	$f = 0.1 \text{ GHz}$		20.5	
ΔG_p	Gain Flatness	$f = 0.1 \text{ to } 0.6 \text{ GHz}$		± 0.7	
$f_3 \text{ dB}$	3 dB Bandwidth			1.0	
VSWR	Input VSWR	$f = 0.1 \text{ to } 1.5 \text{ GHz}$		1.9:1	
	Output VSWR	$f = 0.1 \text{ to } 1.5 \text{ GHz}$		1.8:1	
$P_1 \text{ dB}$	Output Power @ 1 dB Gain Compression,	$f = 0.5 \text{ GHz}$		2.0	
NF	50 Ω Noise Figure	$f = 0.5 \text{ GHz}$		2.8	
IP_3	Third Order Intercept Point	$f = 0.5 \text{ GHz}$		14.5	
t_D	Group Delay	$f = 0.5 \text{ GHz}$		200	
V_d	Device Voltage		3.1	3.5	3.9
dV/dT	Device Voltage Temperature Coefficient			-8.0	

Notes: 1. This chip contains additional biasing options. The performance specified applies only to the bias option whose bond pads are indicated on the chip outline. Refer to the APPLICATIONS section "MODAMP™ Silicon MMIC Chip Use" for additional information.
 2. The recommended operating current range for this device is 12 mA to 30 mA. Typical performance as a function of current is on the following page.
 3. RF performance of the chip is determined by packaging and testing 10 devices per wafer in a dual ground configuration.

MSA-0600 MODAMP™ Cascadable Silicon Bipolar Monolithic Microwave Integrated Circuit Amplifiers

Absolute Maximum Ratings

Parameter	Absolute Maximum ¹
Device Current	50 mA
Power Dissipation ^{2,3}	200 mW
RF Input Power	+20 dBm
Junction Temperature	200°C
Storage Temperature	-65°C to 200°C
Thermal Resistance ^{2,4} : $\theta_{jC} = 50^\circ\text{C/W}$	

Notes:

1. Permanent damage may occur if any of these limits are exceeded.
2. T_{MOUNTING SURFACE} = 25°C
3. Derate at 20 mW/°C for T_{MOUNTING SURFACE} > 190°C.
4. The small spot size of this technique results in a higher, though more accurate determination of θ_{jC} than do alternate methods. See MEASUREMENTS section "Thermal Resistance" for more information.

Part Number Ordering Information

Part Number	Devices Per Tray
MSA-0600-GP2	10
MSA-0600-GP4	100
MSA-0600-GP6	up to 300

Typical Performance, T_A = 25°C

(unless otherwise noted)

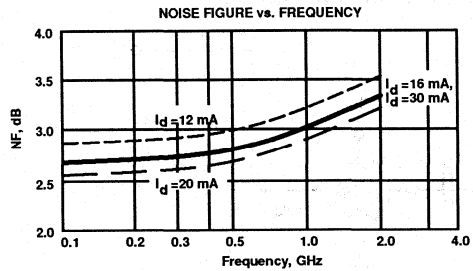
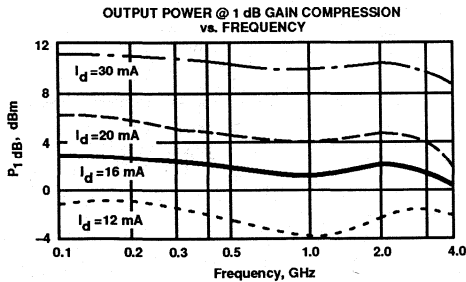
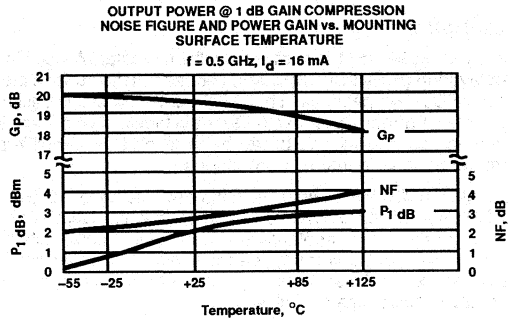
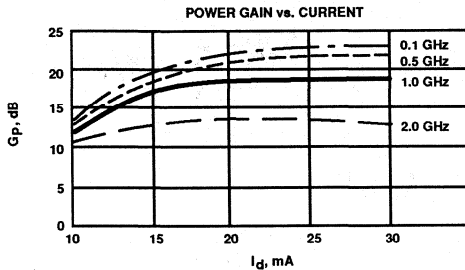

Typical Scattering Parameters⁴: Z₀ = 50 Ω

T_A = 25°C, I_d = 16 mA

Freq. GHz	S ₁₁		S ₂₁			S ₁₂			S ₂₂		k
	Mag	Ang	dB	Mag	Ang	dB	Mag	Ang	Mag	Ang	
0.1	.05	-148	20.6	10.66	173	-23.3	.068	4	.05	-67	1.05
0.2	.07	-134	20.4	10.48	166	-23.1	.070	8	.09	-91	1.04
0.3	.09	-125	20.2	10.28	159	-22.6	.074	13	.13	-102	1.01
0.4	.11	-121	20.0	10.01	151	-22.4	.076	15	.16	-110	1.00
0.5	.13	-120	19.7	9.71	145	-22.1	.078	17	.20	-117	0.98
0.6	.15	-119	19.4	9.34	140	-21.8	.081	20	.22	-124	0.97
0.8	.19	-121	18.7	8.60	123	-20.7	.092	25	.25	-136	0.93
1.0	.25	-123	17.9	7.82	117	-19.8	.102	26	.28	-148	0.90
1.5	.32	-134	15.7	6.10	96	-18.3	.122	29	.29	-168	0.89
2.0	.40	-149	13.5	4.73	79	-17.4	.136	27	.26	-175	0.91
2.5	.45	-157	11.6	3.79	70	-16.9	.142	30	.23	-169	0.97
3.0	.49	-171	9.9	3.12	61	-16.6	.148	28	.19	-168	1.03
3.5	.51	-174	8.3	2.60	51	-16.4	.152	25	.16	-173	1.10
4.0	.51	179	6.9	2.21	43	-16.3	.153	26	.12	-170	1.22
4.5	.51	170	5.7	1.93	37	-16.0	.159	24	.10	-149	1.31
5.0	.51	162	4.7	1.71	29	-15.9	.161	24	.11	-126	1.41

Notes: 4. S-parameters are de-embedded from 70 mil package measured data using the package model found in the DEVICE MODELS section.

Features

- Cascadable 50 Ω Gain Block
- 3 dB Bandwidth: DC to 0.7 GHz
- High Gain: 18.0 dB typical at 0.5 GHz
- Low Noise Figure: 3.0 dB typical at 0.5 GHz
- Low Cost Surface Mount Plastic Package
- Tape-and-Reel Packaging Option Available¹

Description

Avantek's MSA-0611 is a low cost silicon bipolar Monolithic Microwave Integrated Circuit (MMIC) housed in the surface mount plastic SOT-143 package. This MODAMP™ MMIC is designed for use as a general purpose 50 Ω gain block. Typical applications include narrow and broad band IF and RF amplifiers in commercial and industrial applications.

The MODAMP MSA-series is fabricated using a 10 GHz f_T , 25 GHz f_{MAX} silicon bipolar MMIC process which utilizes nitride self-alignment, ion implantation and gold metallization to achieve excellent uniformity, performance, and reliability. The use of an external bias resistor for temperature and current stability also allows bias flexibility.

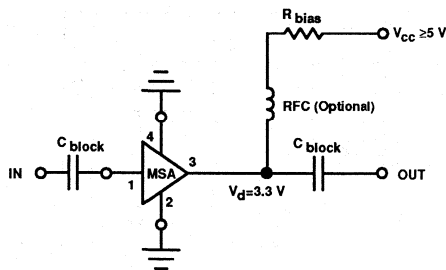
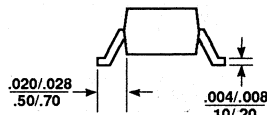
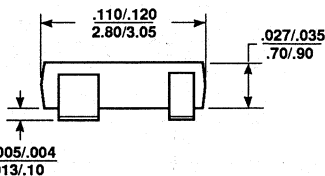
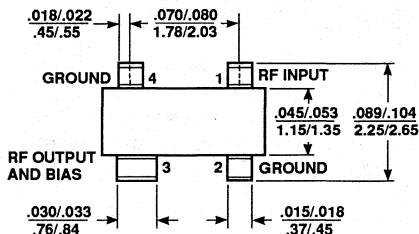
Typical Biasing Configuration

Avantek SOT-143 Package

Notes:
(unless otherwise specified)

Dimensions are:
in (min/max)
mm (min/max)

Electrical Specifications², T_A = 25°C

Symbol	Parameters and Test Conditions: I _d = 16 mA, Z _O = 50 Ω	Units	Min.	Typ.	Max.
G _P	Power Gain (S ₂₁ ²) f = 0.1 GHz f = 0.5 GHz	dB	16.0	19.5 18.0	
ΔG _P	Gain Flatness f = 0.1 to 0.5 GHz	dB		±0.8	
f _{3 dB}	3 dB Bandwidth	GHz		0.7	
VSWR	Input VSWR f = 0.1 to 1.5 GHz			1.6:1	
	Output VSWR f = 0.1 to 1.5 GHz			1.5:1	
P _{1 dB}	Output Power @ 1 dB Gain Compression f = 0.5 GHz	dBm		2.0	
NF	50 Ω Noise Figure f = 0.5 GHz	dB		3.0	
IP ₃	Third Order Intercept Point f = 0.5 GHz	dBm		14.0	
t _D	Group Delay f = 0.5 GHz	psec.		225	
V _d	Device Voltage T _c = 25°C	V	2.6	3.3	4.0
dV/dT	Device Voltage Temperature Coefficient	mV/°C		-8.0	

Notes: 1. Refer to PACKAGING section "Tape-and-Reel Packaging for Surface Mount Semiconductors".

2. The recommended operating current range for this device is 12 mA to 20 mA. Gain performance as a function of current is on the following page.

MSA-0611 MODAMP™ Cascadable Silicon Bipolar Monolithic Microwave Integrated Circuit Amplifiers

Absolute Maximum Ratings

Parameter	Absolute Maximum ¹
Device Current	40 mA
Power Dissipation ^{2,3}	125 mW
RF Input Power	+20 dBm
Junction Temperature	150°C
Storage Temperature	-65°C to 150°C

Thermal Resistance^{2,4}: $\theta_{jC} = 505^\circ\text{C/W}$

Notes:

1. Permanent damage may occur if any of these limits are exceeded.
2. T_{CASE} = 25°C
3. Derate at 2.0 mW/°C for T_C > 87°C.
4. See MEASUREMENTS section "Thermal Resistance" for more information.

Part Number Ordering Information

Part Number	Devices Per Reel	Reel Size
MSA-0611-TR1	3000	7"
MSA-0611-TR2	10000	13"

Typical Performance, T_A = 25°C

(unless otherwise noted)

POWER GAIN vs. FREQUENCY

I_d = 16 mA

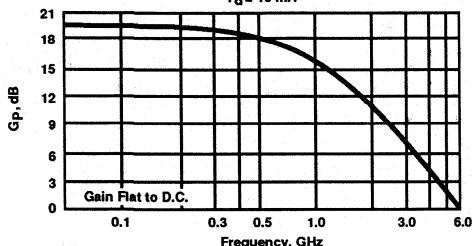

POWER GAIN vs. CURRENT

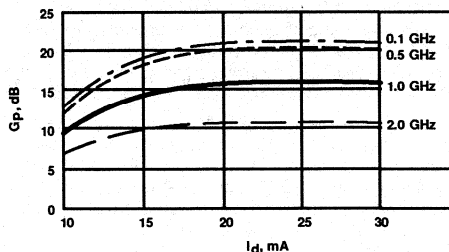

OUTPUT POWER @ 1 dB GAIN COMPRESSION vs. FREQUENCY

I_d = 16 mA

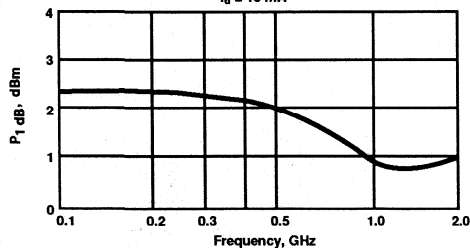

NOISE FIGURE vs. FREQUENCY

I_d = 16 mA

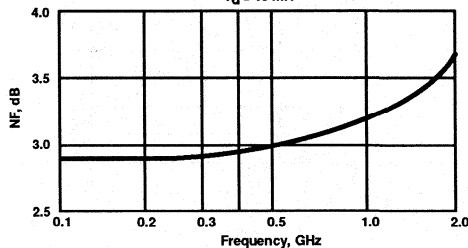

Typical Scattering Parameters: Z₀ = 50 Ω

T_A = 25°C, I_d = 16 mA

Freq. GHz	S ₁₁		S ₂₁			S ₁₂			S ₂₂		k
	Mag	Ang	dB	Mag	Ang	dB	Mag	Ang	Mag	Ang	
0.1	.04	-176	19.6	9.53	170	-23.0	.071	6	.04	-57	1.07
0.2	.03	-163	19.3	9.25	160	-22.7	.073	10	.07	-82	1.07
0.3	.03	-149	18.9	8.79	150	-22.8	.072	14	.09	-97	1.10
0.4	.04	-132	18.5	8.38	141	-21.9	.080	17	.11	-111	1.07
0.5	.05	-127	18.0	7.96	133	-21.6	.083	21	.13	-122	1.07
0.6	.07	-123	17.3	7.33	125	-21.2	.087	23	.15	-131	1.07
0.8	.10	-129	16.2	6.46	111	-19.7	.103	25	.17	-147	1.04
1.0	.13	-139	15.0	5.64	98	-19.0	.112	28	.18	-160	1.06
1.5	.22	-164	12.5	4.22	73	-17.1	.139	25	.19	175	1.07
2.0	.31	171	10.1	3.20	53	-16.1	.157	21	.19	160	1.13
2.5	.39	158	8.1	2.55	42	-15.4	.169	22	.20	153	1.19
3.0	.45	144	6.3	2.07	28	-15.0	.178	18	.19	150	1.26
3.5	.50	132	4.7	1.72	16	-14.6	.185	15	.16	152	1.33
4.0	.52	121	3.4	1.48	4	-14.1	.197	11	.14	166	1.37

A model for this device is available in the DEVICE MODELS section.

Features

- Cascadable 50 Ω Gain Block
- Low Operating Voltage (3.5 V typical V_d)
- 3 dB Bandwidth: DC to 0.9 GHz
- High Gain: 19.0 dB typical at 0.5 GHz
- Low Noise Figure: 2.8 dB typical at 0.5 GHz
- Cost Effective Ceramic Microstrip Package

Description

Avantek's MSA-0635 is a high performance silicon bipolar Monolithic Microwave Integrated Circuit (MMIC) housed in a cost effective, microstrip package. This MODAMP™ MMIC is designed for use as a general purpose 50 Ω gain block. Typical applications include narrow and broad band IF and RF amplifiers in commercial and industrial applications.

The MODAMP MSA-series is fabricated using a 10 GHz f_T , 25 GHz f_{MAX} silicon bipolar MMIC process which utilizes nitride self-alignment, ion implantation and gold metallization to achieve excellent uniformity, performance, and reliability. The use of an external bias resistor for temperature and current stability also allows bias flexibility.

Avantek 35 micro-X Package¹

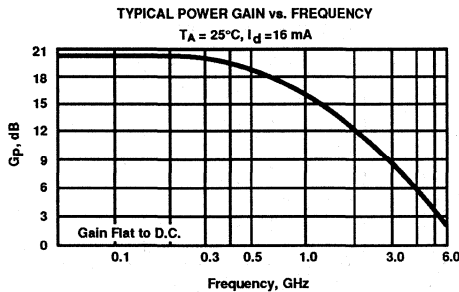
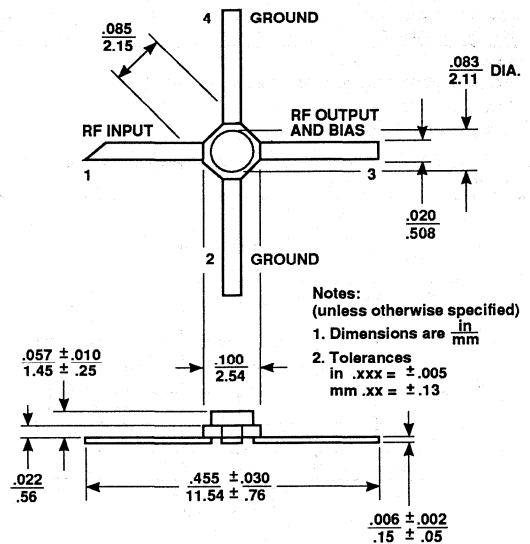

Typical Biasing Configuration

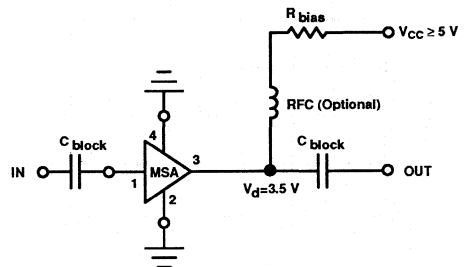

Electrical Specifications², $T_A = 25^\circ\text{C}$

Symbol	Parameters and Test Conditions: $I_d = 16\text{ mA}$, $Z_0 = 50\ \Omega$	Units	Min.	Typ.	Max.	
G_p	Power Gain ($ S_{21} ^2$)	$f = 0.1\text{ GHz}$	dB	19.0	20.5	22.0
ΔG_p	Gain Flatness	$f = 0.1\text{ to }2.5\text{ GHz}$	dB		±0.7	±1.0
$f_3\text{ dB}$	3 dB Bandwidth		GHz	0.9		
VSWR	Input VSWR	$f = 0.1\text{ to }1.5\text{ GHz}$		1.4:1		
	Output VSWR	$f = 0.1\text{ to }1.5\text{ GHz}$		1.3:1		
$P_1\text{ dB}$	Output Power @ 1 dB Gain Compression	$f = 0.5\text{ GHz}$	dBm	2.0		
NF	50 Ω Noise Figure	$f = 0.5\text{ GHz}$	dB	2.8	4.0	
IP_3	Third Order Intercept Point	$f = 0.5\text{ GHz}$	dBm	14.5		
t_D	Group Delay	$f = 0.5\text{ GHz}$	psec.	200		
V_d	Device Voltage		V	3.1	3.5	3.9
dV/dT	Device Voltage Temperature Coefficient		mV/°C		-8.0	

Notes: 1. Short leaded 36 package available upon request.

2. The recommended operating current range for this device is 12 mA to 30 mA. Typical performance as a function of current is on the following page.

MSA-0635 MODAMP™ Cascadable Silicon Bipolar Monolithic Microwave Integrated Circuit Amplifiers

Absolute Maximum Ratings

Parameter	Absolute Maximum ¹
Device Current	50 mA
Power Dissipation ^{2,3}	200 mW
RF Input Power	+20 dBm
Junction Temperature	200°C
Storage Temperature ⁴	-65°C to 200°C

Thermal Resistance^{2,5}: $\theta_{jC} = 155^\circ\text{C/W}$

Notes:

- Permanent damage may occur if any of these limits are exceeded.
- T_{CASE} = 25°C
- Derate at 6.5 mW/°C for T_C > 169°C.
- Storage above +150°C may tarnish the leads of this package making it difficult to solder into a circuit.
- The small spot size of this technique results in a higher, though more accurate determination of θ_{jC} than do alternate methods. See MEASUREMENTS section "Thermal Resistance" for more information.

Typical Performance, T_A = 25°C

(unless otherwise noted)

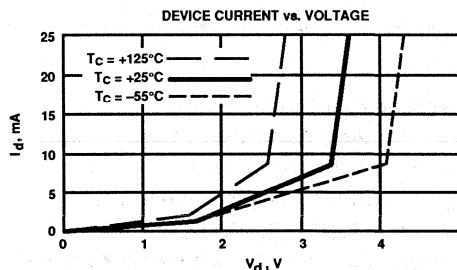

OUTPUT POWER @ 1 dB GAIN COMPRESSION
NOISE FIGURE AND POWER GAIN vs. CASE TEMPERATURE
f = 0.5 GHz, I_d = 16 mA

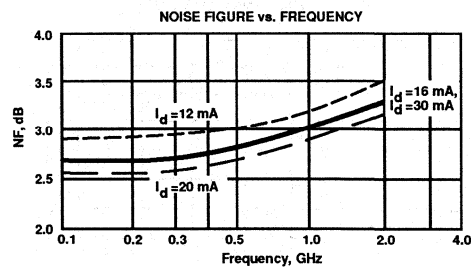
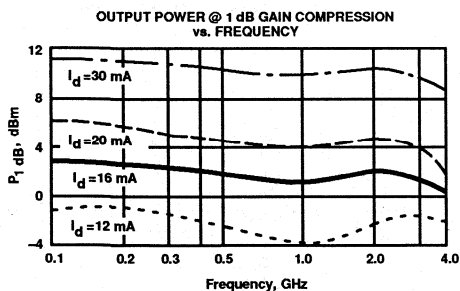
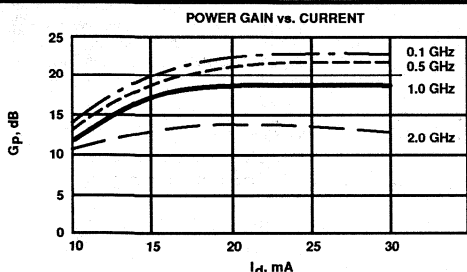
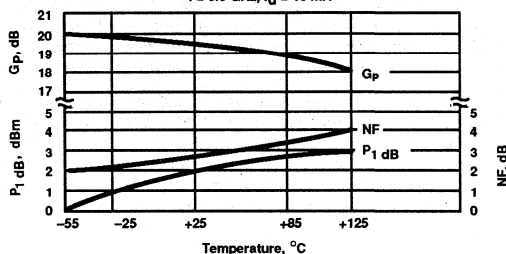

Typical Scattering Parameters: Z₀ = 50 Ω

Freq. GHz	S ₁₁		S ₂₁			S ₁₂			S ₂₂		k
	Mag	Ang	dB	Mag	Ang	dB	Mag	Ang	Mag	Ang	
0.1	.03	-178	20.5	10.59	171	-23.4	.068	5	.04	-44	1.05
0.2	.02	-177	20.3	10.31	161	-22.9	.071	8	.05	-68	1.04
0.3	.02	-164	20.0	9.96	152	-22.4	.076	14	.06	-87	1.04
0.4	.02	-116	19.6	9.55	144	-22.0	.079	19	.07	-104	1.03
0.5	.02	-100	19.2	9.08	136	-21.8	.081	21	.09	-114	1.04
0.6	.04	-89	18.7	8.59	128	-21.3	.086	24	.09	-123	1.04
0.8	.07	-96	17.7	7.66	115	-20.2	.098	29	.10	-140	1.03
1.0	.10	-108	16.6	6.79	103	-19.4	.107	31	.11	-156	1.02
1.5	.17	-134	14.2	5.13	79	-17.2	.138	30	.12	-172	1.03
2.0	.24	-160	12.1	4.01	60	-15.8	.163	26	.12	-148	1.04
2.5	.31	-178	10.3	3.26	48	-15.1	.175	27	.12	-140	1.08
3.0	.37	166	8.7	2.72	34	-14.4	.190	24	.11	-135	1.10
3.5	.42	151	7.4	2.33	21	-13.9	.203	19	.10	-144	1.11
4.0	.46	139	6.2	2.04	9	-13.3	.216	16	.08	-167	1.11
4.5	.48	126	5.1	1.81	-3	-12.8	.229	12	.08	-173	1.11
5.0	.52	110	4.2	1.62	-15	-12.2	.245	8	.09	-173	1.09

A model for this device is available in the DEVICE MODELS section.

Features

- Cascadable 50 Ω Gain Block
- Low Operating Voltage (3.5 V typical V_d)
- 3 dB Bandwidth: DC to 1.0 GHz
- High Gain: 19.5 dB typical at 0.5 GHz
- Low Noise Figure: 2.8 dB typical at 0.5 GHz
- Hermetic Gold-ceramic Microstrip Package

Description

Avantek's MSA-0670 is a high performance silicon bipolar Monolithic Microwave Integrated Circuit (MMIC) housed in a hermetic, high reliability package. This MODAMP™ MMIC is designed for use as a general purpose 50 Ω gain block. Typical applications include narrow and broad band IF and RF amplifiers in industrial and military applications.

The MODAMP MSA-series is fabricated using a 10 GHz f_T , 25 GHz f_{MAX} silicon bipolar MMIC process which utilizes nitride self-alignment, ion implantation and gold metallization to achieve excellent uniformity, performance, and reliability. The use of an external bias resistor for temperature and current stability also allows bias flexibility.

Avantek 70 mil Package

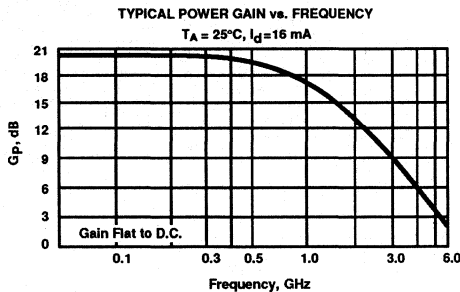
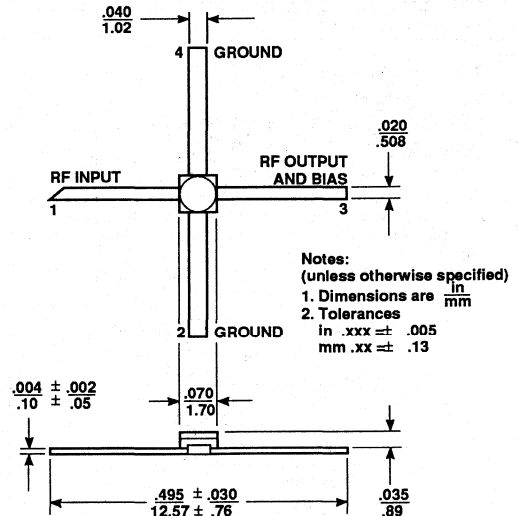

Typical Biasing Configuration

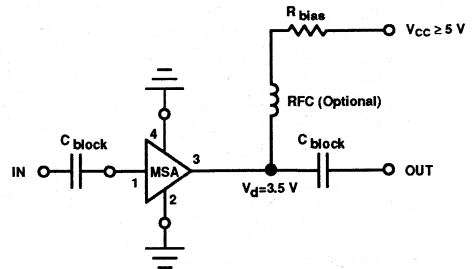

Electrical Specifications¹, $T_A = 25^\circ\text{C}$

Symbol	Parameters and Test Conditions: $I_d = 16\text{ mA}, Z_0 = 50\ \Omega$	Units	Min.	Typ.	Max.
G_P	Power Gain ($ S_{21} ^2$) $f = 0.1\text{ GHz}$	dB	19.0	20.5	22.0
ΔG_P	Gain Flatness $f = 0.1\text{ to }0.6\text{ GHz}$	dB		± 0.7	± 1.0
$f_{3\text{ dB}}$	3 dB Bandwidth	GHz		1.0	
VSWR	Input VSWR $f = 0.1\text{ to }1.5\text{ GHz}$			1.9:1	
	Output VSWR $f = 0.1\text{ to }1.5\text{ GHz}$			1.8:1	
P_1 dB	Output Power @ 1 dB Gain Compression $f = 0.5\text{ GHz}$	dBm		2.0	
NF	50 Ω Noise Figure $f = 0.5\text{ GHz}$	dB		2.8	4.0
IP_3	Third Order Intercept Point $f = 0.5\text{ GHz}$	dBm		14.5	
t_D	Group Delay $f = 0.5\text{ GHz}$	psec.		200	
V_d	Device Voltage	V	3.1	3.5	3.9
dV/dT	Device Voltage Temperature Coefficient	$\text{mV}/^\circ\text{C}$		-8.0	

Note: 1. The recommended operating current range for this device is 12 mA to 30 mA. Typical performance as a function of current is on the following page.

MSA-0670 MODAMP™ Cascadable Silicon Bipolar Monolithic Microwave Integrated Circuit Amplifiers

Absolute Maximum Ratings

Parameter	Absolute Maximum ¹
Device Current	50 mA
Power Dissipation ^{2,3}	200 mW
RF Input Power	+20 dBm
Junction Temperature	200°C
Storage Temperature	-65°C to 200°C

Thermal Resistance^{2,4}: $\theta_{jC} = 130^\circ\text{C/W}$

Notes:

- Permanent damage may occur if any of these limits are exceeded.
- T_{CASE} = 25°C
- Derate at 7.7 mW/°C for T_C > 174°C.
- The small spot size of this technique results in a higher, though more accurate determination of θ_{jC} than do alternate methods. See MEASUREMENTS section "Thermal Resistance" for more information.

Typical Performance, T_A = 25°C

(unless otherwise noted)

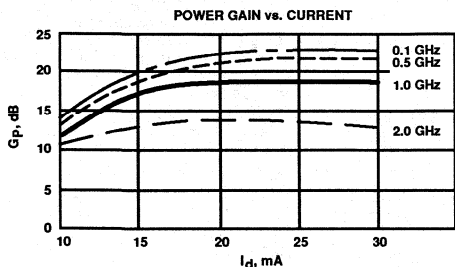
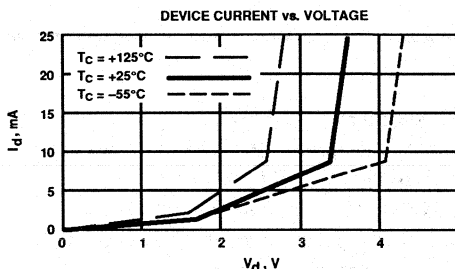

OUTPUT POWER @ 1 dB GAIN COMPRESSION
NOISE FIGURE AND POWER GAIN vs. CASE TEMPERATURE
f = 0.5 GHz, I_d = 16 mA

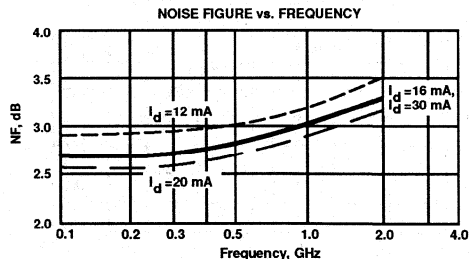
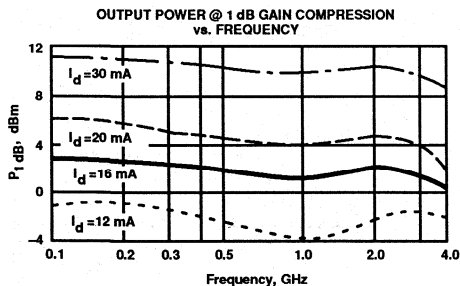
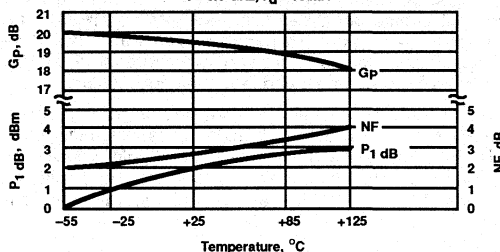

Typical Scattering Parameters: Z_O = 50 Ω

T_A = 25°C, I_d = 16 mA

Freq. GHz	S ₁₁		S ₂₁			S ₁₂			S ₂₂		k
	Mag	Ang	dB	Mag	Ang	dB	Mag	Ang	Mag	Ang	
0.1	.05	-147	20.5	10.62	172	-23.3	.068	4	.05	-69	1.05
0.2	.07	-134	20.4	10.41	164	-23.0	.070	8	.09	-92	1.04
0.3	.09	-126	20.1	10.16	156	-22.6	.074	12	.13	-104	1.02
0.4	.11	-123	19.9	9.85	148	-22.4	.076	14	.16	-113	1.00
0.5	.13	-123	19.6	9.50	141	-22.0	.079	16	.20	-121	0.99
0.6	.15	-123	19.2	9.09	135	-21.8	.082	18	.22	-128	0.97
0.8	.19	-126	18.4	8.28	122	-20.7	.093	22	.25	-141	0.94
1.0	.24	-129	17.5	7.46	110	-19.8	.103	22	.27	-154	0.92
1.5	.31	-141	15.2	5.76	87	-18.2	.124	23	.27	-176	0.91
2.0	.38	-157	13.0	4.47	68	-17.2	.138	19	.24	-166	0.94
2.5	.42	-167	11.1	3.59	57	-16.7	.146	20	.21	-158	1.01
3.0	.46	178	9.5	2.97	45	-16.4	.152	16	.17	-156	1.07
3.5	.48	173	7.9	2.49	33	-16.2	.155	11	.14	-163	1.15
4.0	.48	164	6.6	2.13	22	-16.1	.156	9	.11	-175	1.27
4.5	.48	155	5.5	1.87	13	-15.9	.161	5	.11	-154	1.35
5.0	.48	143	4.5	1.67	3	-15.8	.163	3	.14	-141	1.46

A model for this device is available in the DEVICE MODELS section.

Features

- Cascadable 50 Ω Gain Block
- Low Operating Voltage (3.5 V typical V_d)
- 3 dB Bandwidth: DC to 0.8 GHz
- High Gain: 18.5 dB typical at 0.5 GHz
- Low Noise Figure: 3.0 dB typical at 0.5 GHz
- Low Cost Plastic Package

Description

Avantek's MSA-0685 is a high performance silicon bipolar Monolithic Microwave Integrated Circuit (MMIC) housed in a low cost plastic package. This MODAMP™ MMIC is designed for use as a general purpose 50 Ω gain block. Typical applications include narrow and broad band IF and RF amplifiers in commercial and industrial applications.

The MODAMP MSA-series is fabricated using a 10 GHz f_T , 25 GHz f_{MAX} silicon bipolar MMIC process which utilizes nitride self-alignment, ion implantation and gold metallization to achieve excellent uniformity, performance, and reliability. The use of an external bias resistor for temperature and current stability also allows bias flexibility.

Avantek 85 Plastic Package

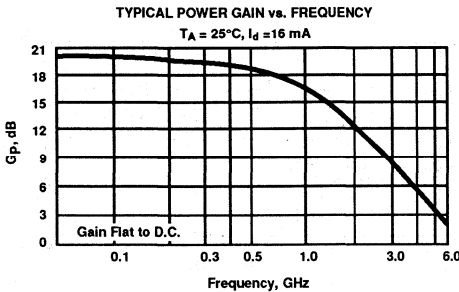
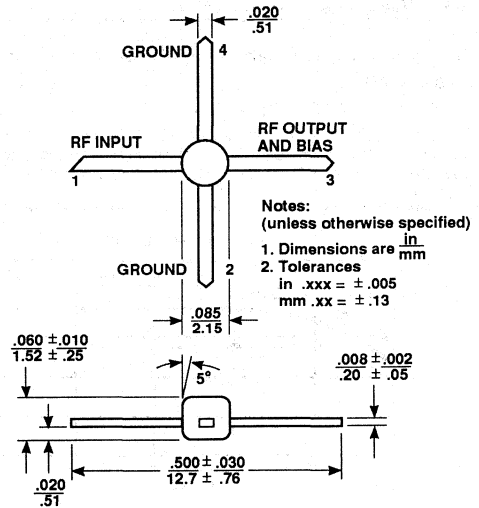

Typical Biasing Configuration

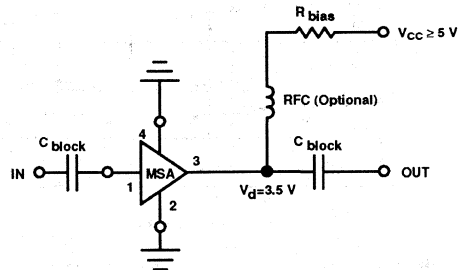

Electrical Specifications¹, TA = 25°C

Symbol	Parameters and Test Conditions: $I_d = 16$ mA, $Z_0 = 50$ Ω	Units	Min.	Typ.	Max.
G_p	Power Gain ($ S_{21} ^2$) $f = 0.1$ GHz $f = 0.5$ GHz	dB	17.0	20.0 18.5	
ΔG_p	Gain Flatness $f = 0.1$ to 0.5 GHz	dB		± 0.7	
f_{3dB}	3 dB Bandwidth	GHz		0.8	
VSWR	Input VSWR $f = 0.1$ to 1.5 GHz			1.5:1	
	Output VSWR $f = 0.1$ to 1.5 GHz			1.4:1	
P_{1dB}	Output Power @ 1 dB Gain Compression $f = 0.5$ GHz	dBm		2.0	
NF	50 Ω Noise Figure $f = 0.5$ GHz	dB		3.0	
IP ₃	Third Order Intercept Point $f = 0.5$ GHz	dBm		14.5	
t_D	Group Delay $f = 0.5$ GHz	psec		200	
V_d	Device Voltage	V	2.8	3.5	4.2
dV/dT	Device Voltage Temperature Coefficient	mV/°C		-8.0	

Note: 1. The recommended operating current range for this device is 12 mA to 25 mA. Typical performance as a function of current is on the following page.

MSA-0685 MODAMP™ Cascadable Silicon Bipolar Monolithic Microwave Integrated Circuit Amplifiers

Absolute Maximum Ratings

Parameter	Absolute Maximum ¹
Device Current	50 mA
Power Dissipation ^{2,3}	200 mW
RF Input Power	+20 dBm
Junction Temperature	150°C
Storage Temperature	-65°C to 150°C
Thermal Resistance ^{2,4} : $\theta_{jc} = 110^\circ\text{C/W}$	

Notes:

1. Permanent damage may occur if any of these limits are exceeded.
2. TCASE = 25°C
3. Derate at 9.1 mW/°C for TC > 128°C.
4. See MEASUREMENTS section "Thermal Resistance" for more information.

Typical Performance, T_A = 25°C

(unless otherwise noted)

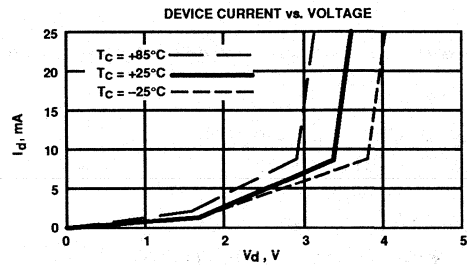

OUTPUT POWER @ 1 dB GAIN COMPRESSION
NOISE FIGURE AND POWER GAIN vs. CASE TEMPERATURE
f = 0.5 GHz, I_d = 16 mA

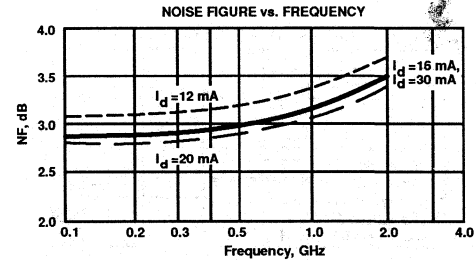
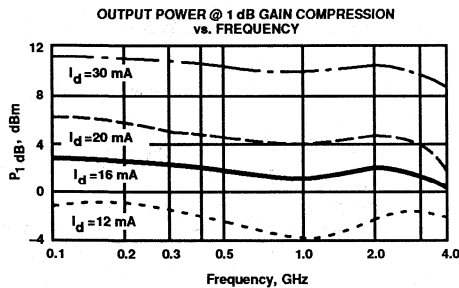
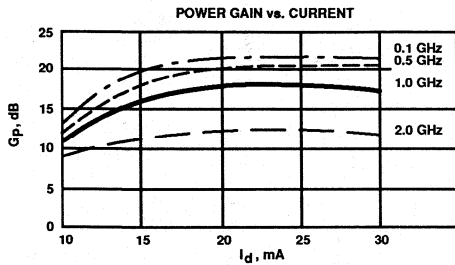
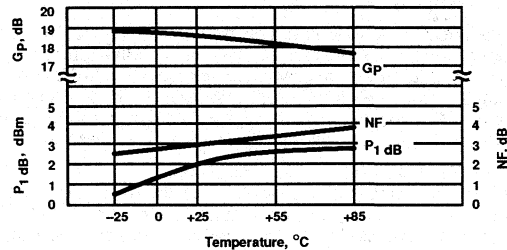

Typical Scattering Parameters: Z₀ = 50 Ω

T_A = 25°C, I_d = 16 mA

Freq. GHz	S ₁₁		S ₂₁			S ₁₂			S ₂₂		k
	Mag	Ang	dB	Mag	Ang	dB	Mag	Ang	Mag	Ang	
0.1	.04	171	20.1	10.09	171	-22.5	.075	5	.04	-30	1.04
0.2	.02	-180	19.8	9.75	161	-22.4	.076	10	.05	-56	1.04
0.3	.02	-143	19.4	9.38	153	-22.2	.077	15	.07	-76	1.05
0.4	.03	-113	19.1	8.99	145	-21.8	.081	17	.08	-91	1.04
0.5	.05	-105	18.7	8.57	138	-21.3	.086	21	.10	-104	1.04
0.6	.07	-101	18.2	8.14	131	-20.7	.092	25	.11	-116	1.03
0.8	.10	-111	17.3	7.32	119	-19.7	.103	28	.13	-134	1.01
1.0	.13	-118	16.4	6.57	107	-18.8	.115	28	.14	-150	0.99
1.5	.21	-140	14.1	5.06	84	-17.1	.140	28	.15	180	1.00
2.0	.29	-163	12.0	3.98	65	-15.8	.163	26	.16	157	1.02
2.5	.34	-176	10.3	3.26	55	-15.2	.174	28	.16	150	1.06
3.0	.41	169	8.7	2.71	42	-14.8	.181	25	.15	143	1.10
3.5	.46	157	7.2	2.31	30	-14.2	.194	22	.13	144	1.11
4.0	.49	146	6.1	2.01	18	-13.8	.203	20	.10	156	1.13
4.5	.52	135	5.0	1.77	7	-13.4	.215	17	.09	173	1.14
5.0	.54	123	4.1	1.60	-3	-12.9	.226	15	.09	-178	1.14

A model for this device is available in the DEVICE MODELS section.

Features

- Cascadable 50 Ω Gain Block
- Low Operating Voltage (3.5 V typical V_d)
- 3 dB Bandwidth: DC to 0.8 GHz
- High Gain: 18.5 dB typical at 0.5 GHz
- Low Noise Figure: 3.0 dB typical at 0.5 GHz
- Surface Mount Plastic Package
- Tape-and-Reel Packaging Option Available¹

Description

Avantek's MSA-0686 is a high performance silicon bipolar Monolithic Microwave Integrated Circuit (MMIC) housed in a low cost, surface mount plastic package. This MODAMP™ MMIC is designed for use as a general purpose 50 Ω gain block. Applications include narrow and broad band IF and RF amplifiers in commercial and industrial applications.

The MODAMP MSA-series is fabricated using a 10 GHz f_T , 25 GHz f_{MAX} silicon bipolar MMIC process which utilizes nitride self-alignment, ion implantation and gold metallization to achieve excellent uniformity, performance, and reliability. The use of an external bias resistor for temperature and current stability also allows bias flexibility.

Avantek 86 Plastic Package

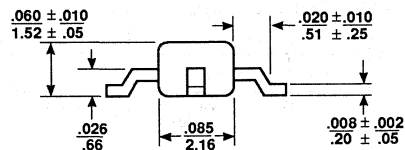
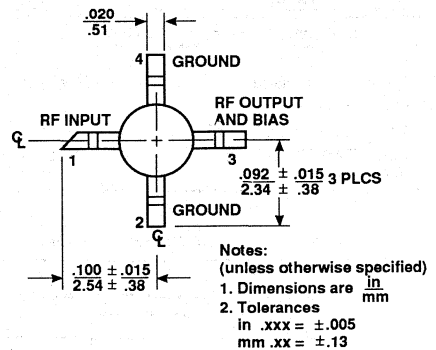

Typical Biasing Configuration

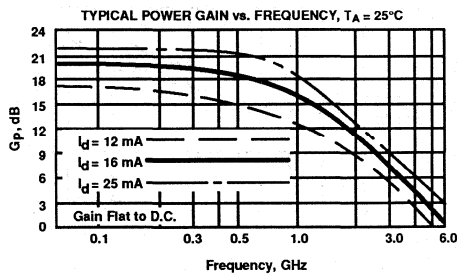
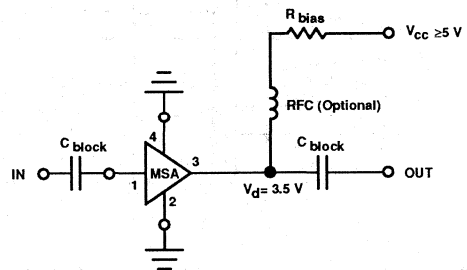

Electrical Specifications², $T_A = 25^\circ\text{C}$

Symbol	Parameters and Test Conditions: $I_d = 16\text{ mA}$, $Z_0 = 50\ \Omega$	Units	Min.	Typ.	Max.
G_p	Power Gain ($ S_{21} ^2$) $f = 0.1\text{ GHz}$ $f = 0.5\text{ GHz}$	dB	16.5	20.0 18.5	
ΔG_p	Gain Flatness $f = 0.1\text{ to }0.5\text{ GHz}$	dB		±0.7	
$f_{3\text{ dB}}$	3 dB Bandwidth	GHz		0.8	
VSWR	Input VSWR $f = 0.1\text{ to }1.5\text{ GHz}$			1.7:1	
	Output VSWR $f = 0.1\text{ to }1.5\text{ GHz}$			1.7:1	
$P_{1\text{ dB}}$	Output Power @ 1 dB Gain Compression $f = 0.5\text{ GHz}$	dBm		2.0	
NF	50Ω Noise Figure $f = 0.5\text{ GHz}$	dB		3.0	
IP_3	Third Order Intercept Point $f = 0.5\text{ GHz}$	dBm		14.5	
t_D	Group Delay $f = 0.5\text{ GHz}$	psec.		225	
V_d	Device Voltage	V	2.8	3.5	4.2
dV/dT	Device Voltage Temperature Coefficient	$\text{mV}/^\circ\text{C}$		-8.0	

Notes: 1. Refer to PACKAGING section "Tape-and-Reel Packaging for Surface Mount Semiconductors".

2. The recommended operating current range for this device is 12 mA to 30 mA. Typical performance as a function of current is on the following page.

MSA-0686 MODAMP™ Cascadable Silicon Bipolar Monolithic Microwave Integrated Circuit Amplifiers

Absolute Maximum Ratings

Parameter	Absolute Maximum ¹
Device Current	50 mA
Power Dissipation ^{2,3}	200 mW
RF Input Power	+20 dBm
Junction Temperature	150°C
Storage Temperature	-65°C to 150°C

Thermal Resistance^{2,4}: $\theta_{jc} = 120^\circ\text{C/W}$

Notes:

- Permanent damage may occur if any of these limits are exceeded.
- $T_{CASE} = 25^\circ\text{C}$
- Derate at 8.3 mW/°C for $T_C > 126^\circ\text{C}$.
- See MEASUREMENTS section "Thermal Resistance" for more information.

Part Number Ordering Information

Part Number	Devices Per Reel	Reel Size
MSA-0686-TR1	1000	7"
MSA-0686-TR2	4000	13"

Typical Performance, $T_A = 25^\circ\text{C}$

(unless otherwise noted)

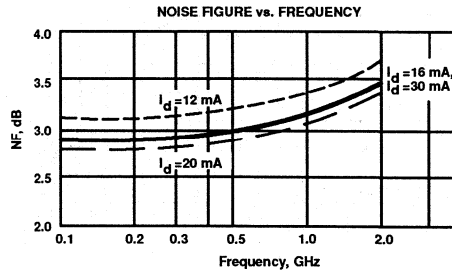
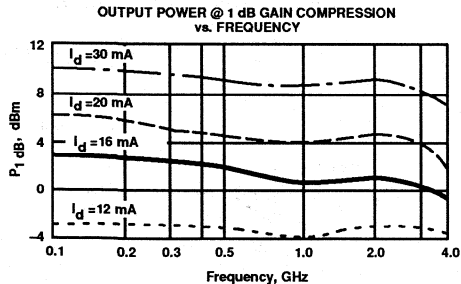
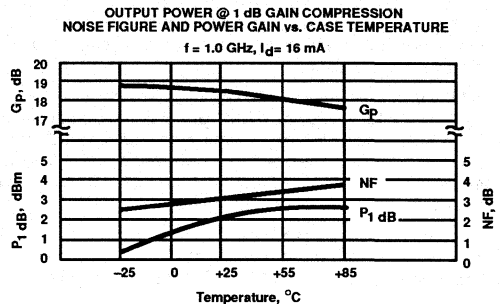
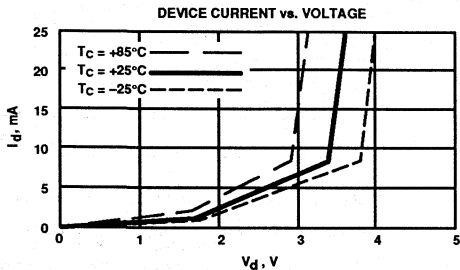

Typical Scattering Parameters: $Z_0 = 50 \Omega$

Freq. GHz	S_{11}		S_{21}		S_{12}		S_{22}		k		
	Mag	Ang	dB	Mag	Ang	dB	Mag	Ang			
0.1	.06	-175	20.1	10.08	170	-23.3	.069	4	.04	-84	1.05
0.2	.06	-169	19.8	9.77	161	-23.2	.069	8	.07	-103	1.05
0.3	.07	-164	19.4	9.35	152	-22.5	.075	13	.10	-113	1.03
0.4	.08	-158	19.1	8.98	144	-22.2	.078	16	.13	-123	1.02
0.5	.08	-154	18.7	8.58	135	-21.6	.083	18	.15	-131	1.01
0.6	.09	-152	18.0	7.94	128	-21.1	.088	21	.18	-140	1.01
0.8	.12	-152	17.2	7.25	114	-20.3	.097	25	.21	-155	1.00
1.0	.15	-154	16.3	6.51	102	-19.5	.106	25	.24	-168	0.99
1.5	.25	-171	14.0	5.01	76	-17.6	.133	22	.27	165	0.99
2.0	.34	171	11.9	3.94	56	-16.1	.157	19	.27	147	1.01
2.5	.43	155	9.8	3.09	42	-15.9	.161	16	.27	134	1.06
3.0	.49	140	8.0	2.51	28	-15.3	.171	11	.26	124	1.10
3.5	.56	128	6.4	2.09	15	-15.1	.175	6	.25	118	1.13
4.0	.61	118	5.0	1.78	3	-14.9	.180	3	.24	115	1.15
5.0	.70	99	2.4	1.32	-18	-14.7	.185	-2	.24	118	1.16

A model for this device is available in the DEVICE MODELS section.

Features

- Cascadable 50 Ω Gain Block
- Low Operating Voltage (4.0 V typical V_d)
- 3 dB Bandwidth: DC to 2.5 GHz
- 13.0 dB typical Gain at 1.0 GHz

Description

Avantek's MSA-0700 is a high performance silicon bipolar Monolithic Microwave Integrated Circuit (MMIC) chip. This MODAMP™ MMIC is designed for use as a general purpose 50 Ω gain block. Typical applications include narrow and broad band IF and RF amplifiers in commercial, industrial and military applications.

The MODAMP MSA-series is fabricated using a 10 GHz f_T , 25 GHz f_{MAX} silicon bipolar MMIC process which utilizes nitride self-alignment, ion implantation and gold metallization to achieve excellent uniformity, performance, and reliability. The use of an external bias resistor for temperature and current stability also allows bias flexibility.

The recommended assembly procedure is gold-eutectic die attach at 400°C and either wedge or ball bonding using 0.7 mil gold wire. See APPLICATIONS section, "Chip Use".

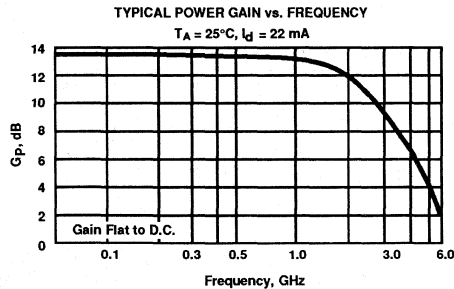
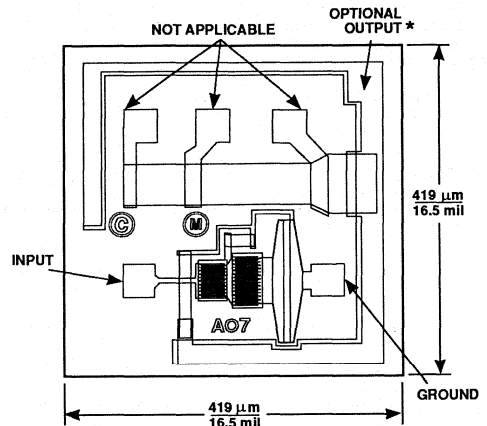
Avantek Chip Outline¹

Unless otherwise specified, tolerances are $\pm 13\ \mu\text{m} / \pm 0.5\ \text{mil}$.
Chip thickness is $114\ \mu\text{m} / 4.5\ \text{mil}$. Bond pads are $41\ \mu\text{m} / 1.6\ \text{mil}$ typical on each side.
* Output contact is made by die attaching the backside of the die.

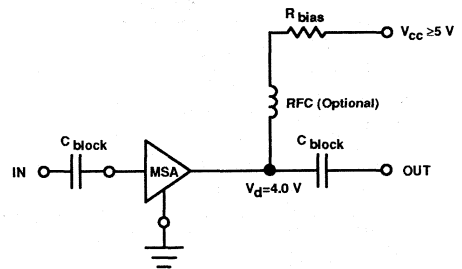
Typical Biasing Configuration

Electrical Specifications², $T_A = 25^\circ\text{C}$

Symbol	Parameters and Test Conditions ³ : $I_d = 22\ \text{mA}$, $Z_0 = 50\ \Omega$	Units	Min.	Typ.	Max.
G_p	Power Gain ($ S_{21} ^2$) $f = 0.1\ \text{GHz}$	dB		13.5	
ΔG_p	Gain Flatness $f = 0.1\ \text{to}\ 1.5\ \text{GHz}$	dB		± 0.6	
$f_3\ \text{dB}$	3 dB Bandwidth	GHz		2.5	
VSWR	Input VSWR $f = 0.1\ \text{to}\ 2.5\ \text{GHz}$			2.0:1	
	Output VSWR $f = 0.1\ \text{to}\ 2.5\ \text{GHz}$			1.6:1	
$P_1\ \text{dB}$	Output Power @ 1 dB Gain Compression, $f = 1.0\ \text{GHz}$	dBm		5.5	
NF	50 Ω Noise Figure $f = 1.0\ \text{GHz}$	dB		4.5	
IP_3	Third Order Intercept Point $f = 1.0\ \text{GHz}$	dBm		19.0	
t_D	Group Delay $f = 1.0\ \text{GHz}$	psec.		130	
V_d	Device Voltage	V	3.6	4.0	4.4
dV/dT	Device Voltage Temperature Coefficient	$\text{mV}/^\circ\text{C}$		-7.0	

Notes: 1. This chip contains additional biasing options. The performance specified applies only to the bias option whose bond pads are indicated on the chip outline. Refer to the APPLICATIONS section "MODAMP™ Silicon MMIC Chip Use" for additional information.

2. The recommended operating current range for this device is 15 mA to 40 mA. Typical performance as a function of current is on the following page.

3. RF performance of the chip is determined by packaging and testing 10 devices per wafer in a dual ground configuration.

MSA-0700 MODAMP™ Cascadable Silicon Bipolar Monolithic Microwave Integrated Circuit Amplifiers

Absolute Maximum Ratings

Parameter	Absolute Maximum ¹
Device Current	60 mA
Power Dissipation ^{2,3}	275 mW
RF Input Power	+20 dBm
Junction Temperature	200°C
Storage Temperature	-65°C to 200°C

Thermal Resistance^{2,4}: $\theta_{jc} = 50^\circ\text{C/W}$

Notes:

- Permanent damage may occur if any of these limits are exceeded.
- T_{MOUNTING SURFACE} = 25°C
- Derate at 20 mW/°C for T_{MOUNTING SURFACE} > 186°C.
- The small spot size of this technique results in a higher, though more accurate determination of θ_{jc} than do alternate methods. See MEASUREMENTS section "Thermal Resistance" for more information.

Part Number Ordering Information

Part Number	Devices Per Tray
MSA-0700-GP2	10
MSA-0700-GP4	up to 100
MSA-0700-GP6	up to 300

Typical Performance, T_A = 25°C

(unless otherwise noted)

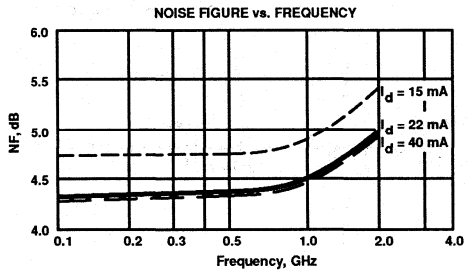
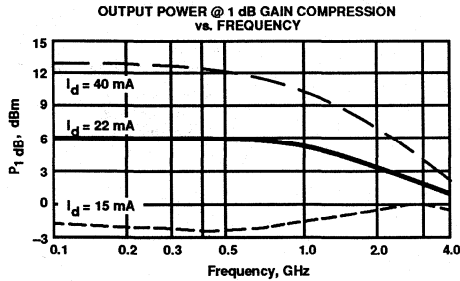
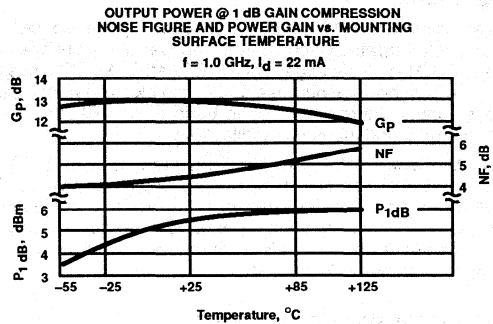
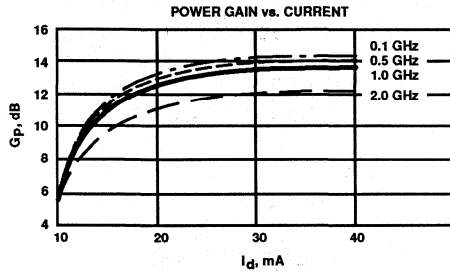

Typical Scattering Parameters⁴: Z₀ = 50 Ω

T_A = 25°C, I_d = 22 mA

Freq. GHz	S ₁₁		S ₂₁			S ₁₂			S ₂₂		k
	Mag	Ang	dB	Mag	Ang	dB	Mag	Ang	Mag	Ang	
0.1	.04	-5	13.5	4.75	176	-18.6	.118	2	.20	-9	1.14
0.2	.05	-8	13.5	4.74	172	-18.4	.120	3	.19	-16	1.14
0.4	.06	-19	13.5	4.74	163	-18.3	.121	7	.20	-30	1.13
0.6	.08	-32	13.5	4.71	156	-18.1	.124	9	.21	-44	1.12
0.8	.10	-41	13.4	4.67	147	-17.5	.133	12	.23	-69	1.07
1.0	.12	-50	13.2	4.59	138	-17.6	.133	13	.23	-68	1.07
1.5	.20	-73	12.7	4.30	117	-16.6	.147	17	.23	-91	1.01
2.0	.31	-98	12.1	4.05	97	-15.8	.163	17	.22	-105	0.94
2.5	.38	-112	11.0	3.55	85	-15.3	.171	18	.18	-103	0.93
3.0	.43	-128	9.6	3.01	69	-15.3	.171	17	.19	-96	0.97
3.5	.48	-141	8.2	2.57	56	-15.3	.172	17	.21	-87	1.01
4.0	.48	-153	6.8	2.20	45	-15.2	.174	14	.26	-83	1.07
5.0	.49	-179	4.6	1.70	26	-15.2	.174	12	.31	-86	1.22
6.0	.54	154	2.5	1.34	9	-15.6	.166	13	.33	-98	1.38

Note: 4. S-parameters are de-embedded from 70 mil package measured data using the package model found in the DEVICE MODELS section.

Features

- Cascadable 50 Ω Gain Block
- 3 dB Bandwidth: DC to 1.9 GHz
- 12.0 dB typical Gain at 1.0 GHz
- Unconditionally Stable ($k > 1$)
- Low Cost Surface Mount Plastic Package
- Tape-and-Reel Packaging Option Available¹

Description

Avantek's MSA-0711 is a low cost silicon bipolar Monolithic Microwave Integrated Circuit (MMIC) housed in the surface mount plastic SOT-143 package. This MODAMP™ MMIC is designed for use as a general purpose 50 Ω gain block. Typical applications include narrow and broad band IF and RF amplifiers in commercial and industrial applications.

The MODAMP MSA-series is fabricated using a 10 GHz f_T , 25 GHz f_{MAX} silicon bipolar MMIC process which utilizes nitride self-alignment, ion implantation and gold metallization to achieve excellent uniformity, performance, and reliability. The use of an external bias resistor for temperature and current stability also allows bias flexibility.

Typical Biasing Configuration

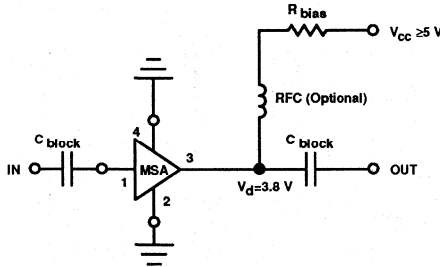

Avantek SOT-143 Package

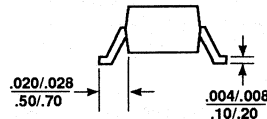
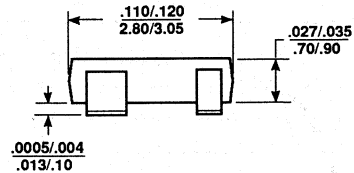
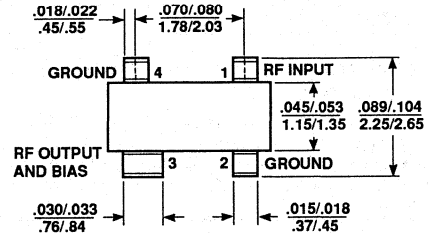

Notes:
(unless otherwise specified)
Dimensions are:
in (min/max)
mm (min/max)

Electrical Specifications², T_A = 25°C

Symbol	Parameters and Test Conditions: I _d = 22 mA, Z _O = 50 Ω	Units	Min.	Typ.	Max.
G _P	Power Gain (S ₂₁ ²) f = 0.1 GHz f = 1.0 GHz	dB	10.0	13.0 12.0	
ΔG _P	Gain Flatness f = 0.1 to 1.3 GHz	dB		±0.8	
f _{3 dB}	3 dB Bandwidth	GHz		1.9	
VSWR	Input VSWR f = 0.1 to 2.0 GHz			1.5:1	
	Output VSWR f = 0.1 to 2.0 GHz			1.5:1	
P _{1 dB}	Output Power @ 1 dB Gain Compression f = 1.0 GHz	dBm		5.5	
NF	50 Ω Noise Figure f = 1.0 GHz	dB		5.0	
IP ₃	Third Order Intercept Point f = 1.0 GHz	dBm		18.0	
t _D	Group Delay f = 1.0 GHz	psec.		145	
V _d	Device Voltage T _C = 25°C	V	3.0	3.8	4.6
dV/dT	Device Voltage Temperature Coefficient	mV/°C		-7.0	

Notes: 1. Refer to PACKAGING section "Tape-and-Reel Packaging for Surface Mount Semiconductors".
2. The recommended operating current range for this device is 15 mA to 30 mA. Gain performance as a function of current is on the following page.

MSA-0711 MODAMP™ Cascadable Silicon Bipolar Monolithic Microwave Integrated Circuit Amplifiers

Absolute Maximum Ratings

Parameter	Absolute Maximum ¹
Device Current	50 mA
Power Dissipation ^{2,3}	175 mW
RF Input Power	+20 dBm
Junction Temperature	150°C
Storage Temperature	-65°C to 150°C
Thermal Resistance ^{2,4} : $\theta_{JC} = 505^\circ\text{C/W}$	

Notes:

1. Permanent damage may occur if any of these limits are exceeded.
2. TCASE = 25°C
3. Derate at 2.0 mW/°C for $T_C > 62^\circ\text{C}$.
4. See MEASUREMENTS section "Thermal Resistance" for more information.

Part Number Ordering Information

Part Number	Devices Per Reel	Reel Size
MSA-0711-TR1	3000	7"
MSA-0711-TR2	10000	13"

Typical Performance, $T_A = 25^\circ\text{C}$

(unless otherwise noted)

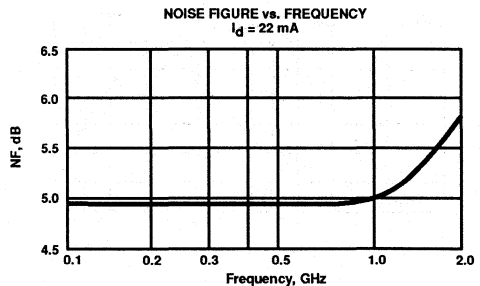
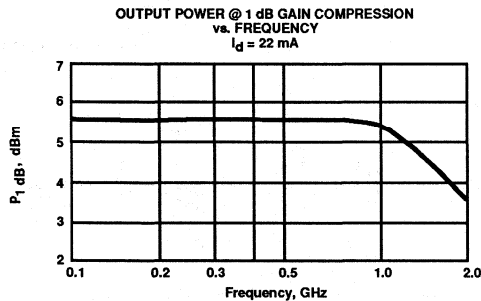
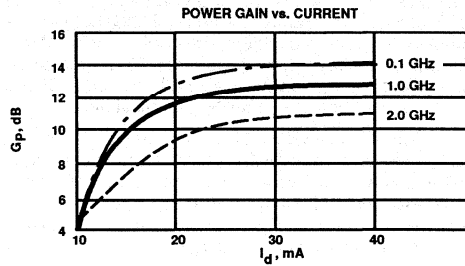
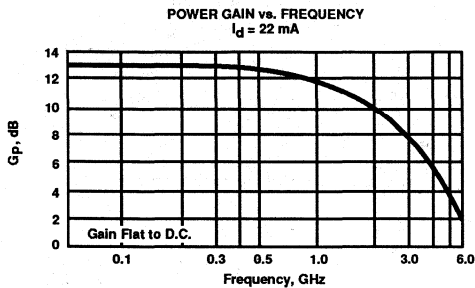

Typical Scattering Parameters: $Z_0 = 50\ \Omega$

$T_A = 25^\circ\text{C}, I_d = 22\text{ mA}$

Freq. GHz	S ₁₁		S ₂₁			S ₁₂			S ₂₂	
	Mag	Ang	dB	Mag	Ang	dB	Mag	Ang	Mag	Ang
0.1	.03	1	13.0	4.47	174	-18.6	.118	1	.19	-8
0.2	.04	1	12.9	4.42	168	-18.5	.119	2	.19	-18
0.4	.04	-4	12.8	4.38	157	-18.4	.120	4	.19	-36
0.6	.05	-19	12.6	4.28	146	-18.1	.125	9	.19	-52
0.8	.07	-32	12.3	4.14	135	-17.7	.130	10	.20	-68
1.0	.08	-44	12.0	3.99	123	-17.4	.135	12	.19	-82
1.5	.13	-88	10.9	3.52	98	-16.1	.157	13	.19	-113
2.0	.18	-130	9.8	3.08	75	-15.2	.173	8	.18	-138
2.5	.25	-155	8.6	2.68	61	-14.7	.184	9	.18	-151
3.0	.32	-178	7.2	2.30	42	-14.7	.185	5	.17	-158
3.5	.38	165	5.8	1.96	26	-14.8	.181	3	.17	-150
4.0	.42	152	4.5	1.68	12	-14.7	.184	1	.20	-142

A model for this device is available in the DEVICE MODELS section.

Features

- Cascadable 50 Ω Gain Block
- Low Operating Voltage (4.0 V typical V_d)
- 3 dB Bandwidth: DC to 2.4 GHz
- 13.0 dB typical Gain at 1.0 GHz
- Unconditionally Stable ($k > 1$)
- Cost Effective Ceramic Microstrip Package

Description

Avantek's MSA-0735 is a high performance silicon bipolar Monolithic Microwave Integrated Circuit (MMIC) housed in a cost effective, microstrip package. This MODAMP™ MMIC is designed for use as a general purpose 50 Ω gain block. Typical applications include narrow and broad band IF and RF amplifiers in industrial and military applications.

The MODAMP MSA-series is fabricated using a 10 GHz f_T , 25 GHz f_{MAX} silicon bipolar MMIC process which utilizes nitride self-alignment, ion implantation and gold metallization to achieve excellent uniformity, performance, and reliability. The use of an external bias resistor for temperature and current stability also allows bias flexibility.

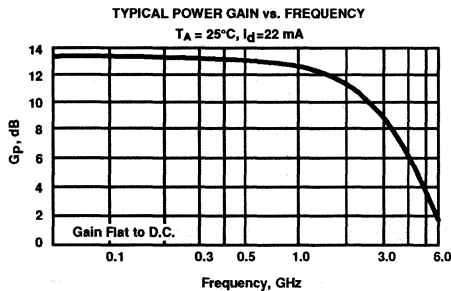
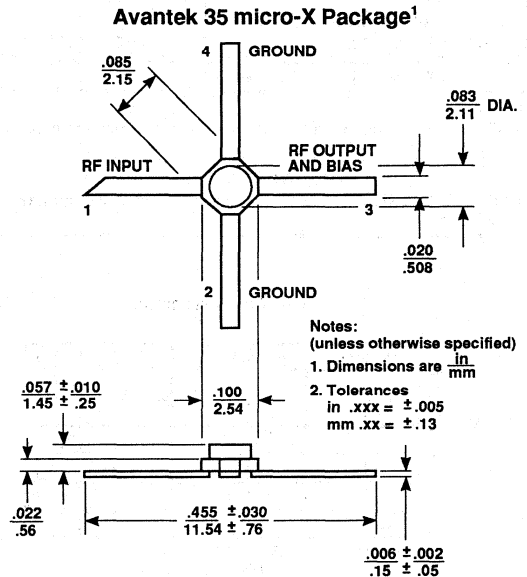

Typical Biasing Configuration

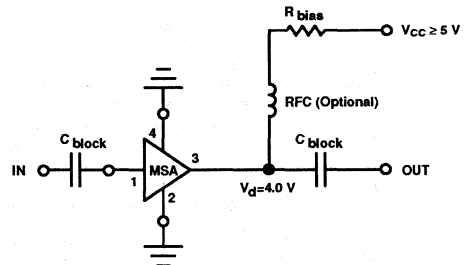

Electrical Specifications², $T_A = 25^\circ\text{C}$

Symbol	Parameters and Test Conditions: $I_d = 22 \text{ mA}, Z_O = 50 \Omega$	Units	Min.	Typ.	Max.
GP	Power Gain ($ S_{21} ^2$)	$f = 0.1 \text{ GHz}$	12.5	13.5	14.5
ΔGP	Gain Flatness	$f = 0.1 \text{ to } 1.3 \text{ GHz}$		±0.6	±1.0
$f_{3 \text{ dB}}$	3 dB Bandwidth			2.4	
VSWR	Input VSWR	$f = 0.1 \text{ to } 2.5 \text{ GHz}$		2.0:1	
	Output VSWR	$f = 0.1 \text{ to } 2.5 \text{ GHz}$		1.8:1	
$P_1 \text{ dB}$	Output Power @ 1 dB Gain Compression	$f = 1.0 \text{ GHz}$		5.5	
NF	50 Ω Noise Figure	$f = 1.0 \text{ GHz}$		4.5	
IP ₃	Third Order Intercept Point	$f = 1.0 \text{ GHz}$		19.0	
t_D	Group Delay	$f = 1.0 \text{ GHz}$		140	
V_d	Device Voltage		3.6	4.0	4.4
dV/dT	Device Voltage Temperature Coefficient			-7.0	

Notes: 1. Short leaded 36 package available upon request.
 2. The recommended operating current range for this device is 15 mA to 40 mA. Typical performance as a function of current is on the following page.

MSA-0735 MODAMP™ Cascadable Silicon Bipolar Monolithic Microwave Integrated Circuit Amplifiers

Absolute Maximum Ratings

Parameter	Absolute Maximum ¹
Device Current	60 mA
Power Dissipation ^{2,3}	275 mW
RF Input Power	+20 dBm
Junction Temperature	200°C
Storage Temperature ⁴	-65°C to 200°C

Thermal Resistance^{2,5}: $\theta_{jc} = 155^\circ\text{C}/\text{W}$

Notes:

- Permanent damage may occur if any of these limits are exceeded.
- $T_{\text{CASE}} = 25^\circ\text{C}$
- Derate at 6.5 mW/°C for $T_C > 157^\circ\text{C}$.
- Storage above +150°C may tarnish the leads of this package making it difficult to solder into a circuit.
- The small spot size of this technique results in a higher, though more accurate determination of θ_{jc} than do alternate methods. See MEASUREMENTS section "Thermal Resistance" for more information.

Typical Performance, $T_A = 25^\circ\text{C}$

(unless otherwise noted)

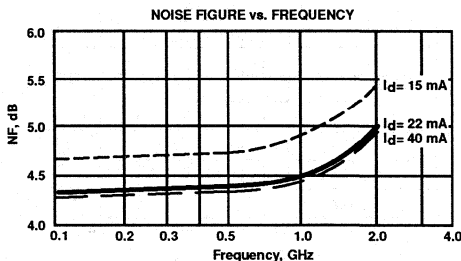
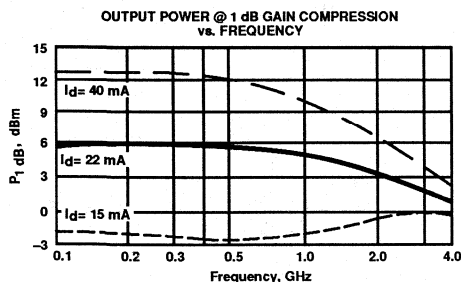
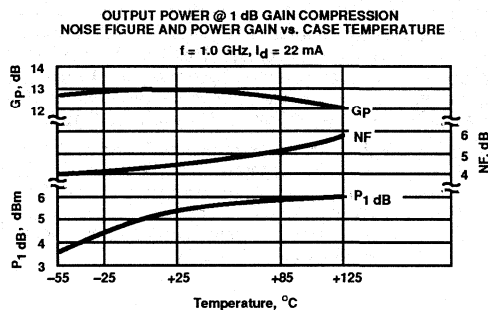
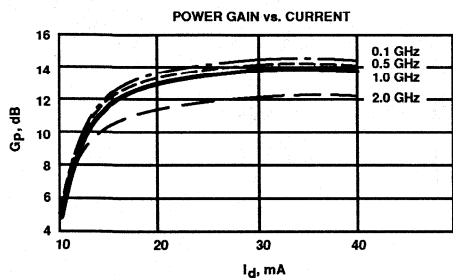
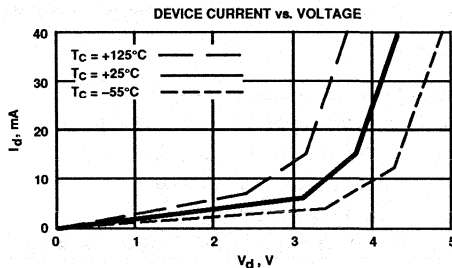

Typical Scattering Parameters: $Z_0 = 50 \Omega$

$T_A = 25^\circ\text{C}, I_d = 22 \text{ mA}$

Freq. GHz	S_{11}		S_{21}			S_{12}			S_{22}	
	Mag	Ang	dB	Mag	Ang	dB	Mag	Ang	Mag	Ang
0.1	.13	-3	13.5	4.71	175	-19.0	.112	2	.29	-7
0.2	.13	-6	13.4	4.69	170	-18.5	.119	3	.29	-12
0.4	.14	-13	13.4	4.68	160	-18.6	.118	6	.29	-24
0.6	.16	-20	13.3	4.64	150	-18.4	.120	7	.28	-35
0.8	.19	-29	13.2	4.60	140	-18.1	.125	8	.28	-47
1.0	.21	-40	12.9	4.42	129	-17.6	.131	10	.27	-58
1.5	.27	-71	12.2	4.07	104	-16.5	.149	10	.24	-83
2.0	.32	-107	11.5	3.74	79	-15.6	.165	7	.19	-103
2.5	.37	-134	10.3	3.26	62	-15.3	.173	5	.15	-113
3.0	.43	-160	8.8	2.76	44	-15.4	.171	0	.14	-120
3.5	.47	-179	7.5	2.37	27	-15.3	.173	-4	.16	-120
4.0	.49	167	6.2	2.05	12	-15.2	.168	-6	.21	-121
5.0	.51	134	4.0	1.59	-15	-15.2	.173	-11	.28	-135
6.0	.60	96	2.1	1.27	-42	-14.6	.185	-16	.29	-167

A model for this device is available in the DEVICE MODELS section.

Features

- Cascadable 50 Ω Gain Block
- Low Operating Voltage (4.0 V typical V_d)
- 3 dB Bandwidth: DC to 2.5 GHz
- 13.0 dB typical Gain at 1.0 GHz
- Unconditionally Stable ($k > 1$)
- Hermetic, Gold-ceramic Microstrip Package

Description

Avantek's MSA-0770 is a high performance silicon bipolar Monolithic Microwave Integrated Circuit (MMIC) housed in a hermetic, high reliability package. This MODAMP™ MMIC is designed for use as a general purpose 50 Ω gain block. Typical applications include narrow and broad band IF and RF amplifiers in industrial and military applications.

The MODAMP MSA-series is fabricated using a 10 GHz f_T , 25 GHz f_{MAX} silicon bipolar MMIC process which utilizes nitride self-alignment, ion implantation and gold metallization to achieve excellent uniformity, performance, and reliability. The use of an external bias resistor for temperature and current stability also allows bias flexibility.

Avantek 70 mil Package

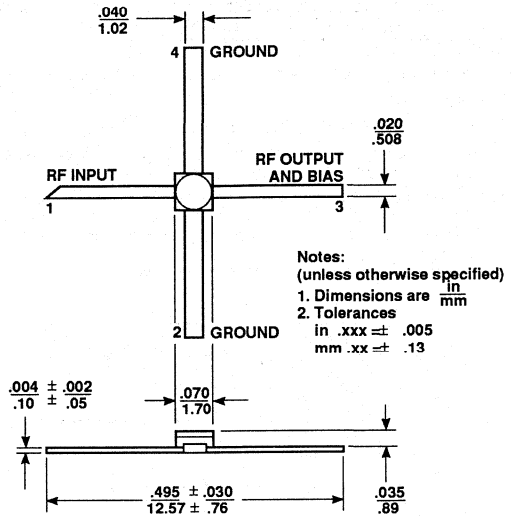

TYPICAL POWER GAIN vs. FREQUENCY
 $T_A = 25^\circ C, I_d = 22 mA$

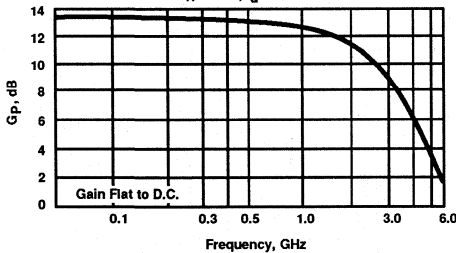

Typical Biasing Configuration

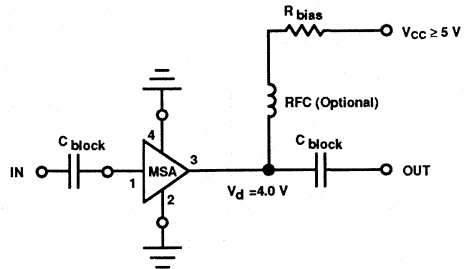

Electrical Specifications¹, $T_A = 25^\circ C$

Symbol	Parameters and Test Conditions: $I_d = 22 mA, Z_0 = 50 \Omega$	Units	Min.	Typ.	Max.
G_p	Power Gain ($ S_{21} ^2$)	f = 0.1 GHz	12.5	13.5	14.5
ΔG_p	Gain Flatness	f = 0.1 to 1.5 GHz		± 0.6	± 1.0
f_3 dB	3 dB Bandwidth			2.5	
VSWR	Input VSWR	f = 0.1 to 2.5 GHz		2.0:1	
	Output VSWR	f = 0.1 to 2.5 GHz		1.6:1	
P_1 dB	Output Power @ 1 dB Gain Compression	f = 1.0 GHz		5.5	
NF	50 Ω Noise Figure	f = 1.0 GHz		4.5	
IP_3	Third Order Intercept Point	f = 1.0 GHz		19.0	
t_D	Group Delay	f = 1.0 GHz		130	
V_d	Device Voltage		3.6	4.0	4.4
dV/dT	Device Voltage Temperature Coefficient			-7.0	

Note: 1. The recommended operating current range for this device is 15 mA to 40 mA. Typical performance as a function of current is on the following page.

MSA-0770 MODAMP™ Cascadable Silicon Bipolar Monolithic Microwave Integrated Circuit Amplifiers

Absolute Maximum Ratings

Parameter	Absolute Maximum ¹
Device Current	60 mA
Power Dissipation ^{2,3}	275 mW
RF Input Power	+20 dBm
Junction Temperature	200°C
Storage Temperature	-65°C to 200°C

Thermal Resistance^{2,4}: $\theta_{jc} = 130^\circ\text{C}/\text{W}$

Notes:

- Permanent damage may occur if any of these limits are exceeded.
- $T_{\text{CASE}} = 25^\circ\text{C}$
- Derate at $7.7 \text{ mW}/^\circ\text{C}$ for $T_{\text{C}} > 164^\circ\text{C}$.
- The small spot size of this technique results in a higher, though more accurate determination of θ_{jc} than do alternate methods. See MEASUREMENTS section "Thermal Resistance" for more information.

Typical Performance, $T_A = 25^\circ\text{C}$

(unless otherwise noted)

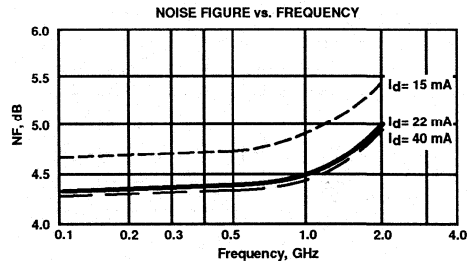
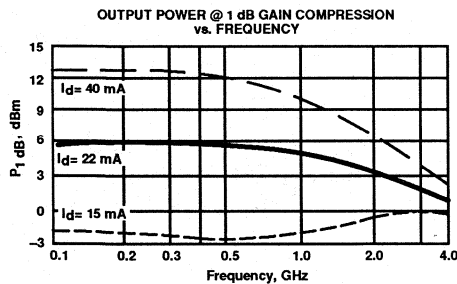
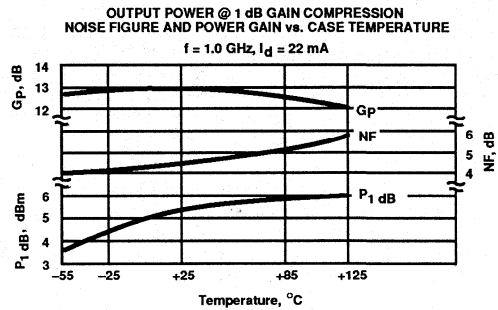
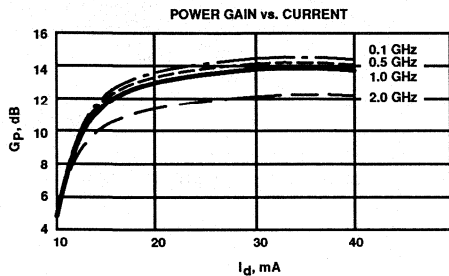
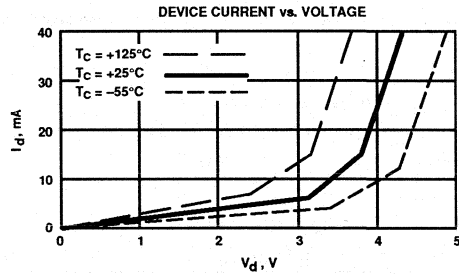

Typical Scattering Parameters: $Z_0 = 50 \Omega$

$T_A = 25^\circ\text{C}, I_d = 22 \text{ mA}$

Freq. GHz	S_{11}		S_{21}			S_{12}			S_{22}	
	Mag	Ang	dB	Mag	Ang	dB	Mag	Ang	Mag	Ang
0.1	.04	-7	13.5	4.74	175	-18.6	.118	2	.20	-10
0.2	.05	-11	13.5	4.72	170	-18.4	.120	2	.19	-18
0.4	.06	-24	13.4	4.70	160	-18.4	.121	6	.20	-34
0.6	.08	-38	13.4	4.65	151	-18.1	.124	7	.21	-50
0.8	.10	-48	13.2	4.58	141	-17.8	.133	9	.23	-76
1.0	.12	-58	13.0	4.47	131	-17.5	.133	9	.23	-76
1.5	.20	-82	12.3	4.12	107	-16.6	.148	10	.23	-101
2.0	.30	-107	11.6	3.82	85	-15.7	.163	8	.22	-116
2.5	.37	-123	10.4	3.33	70	-15.3	.171	7	.19	-116
3.0	.42	-140	9.0	2.83	52	-15.4	.170	3	.20	-111
3.5	.46	-154	7.7	2.42	37	-15.4	.170	1	.23	-107
4.0	.47	-167	6.4	2.08	23	-15.5	.169	-4	.29	-107
5.0	.47	163	4.2	1.63	-1	-15.5	.167	-9	.35	-116
6.0	.51	131	2.3	1.30	-23	-15.9	.160	-11	.38	-133

A model for this device is available in the DEVICE MODELS section.

Features

- Cascadable 50 Ω Gain Block
- Low Operating Voltage (4.0 V typical V_d)
- 3 dB Bandwidth: DC to 2.0 GHz
- 12.5 dB typical Gain at 1.0 GHz
- Unconditionally Stable ($k > 1$)
- Low Cost Plastic Package

Description

Avantek's MSA-0785 is a high performance silicon bipolar Monolithic Microwave Integrated Circuit (MMIC) housed in a low cost plastic package. This MODAMP™ MMIC is designed for use as a general purpose 50 Ω gain block. Typical applications include narrow and broad band IF and RF amplifiers in commercial and industrial applications.

The MODAMP MSA-series is fabricated using a 10 GHz f_T , 25 GHz f_{max} silicon bipolar MMIC process which utilizes nitride self-alignment, ion implantation and gold metallization to achieve excellent uniformity, performance, and reliability. The use of an external bias resistor for temperature and current stability also allows bias flexibility.

Avantek 85 Plastic Package

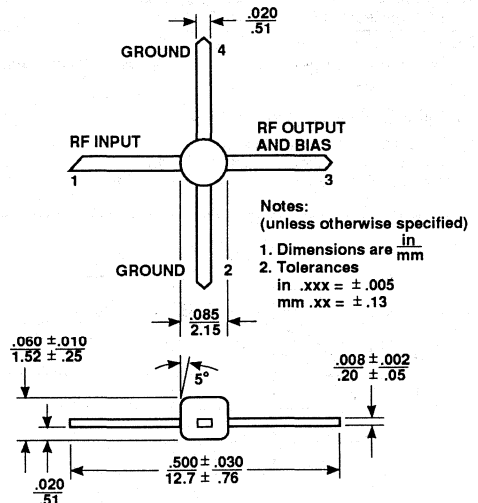

Typical Biasing Configuration

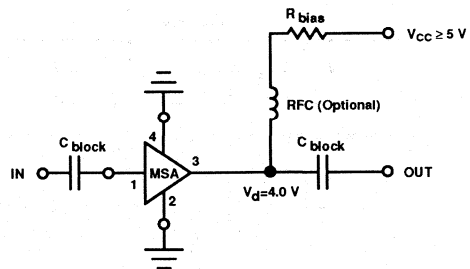

TYPICAL POWER GAIN vs. FREQUENCY
 $T_A = 25^\circ\text{C}, I_d = 22\text{ mA}$

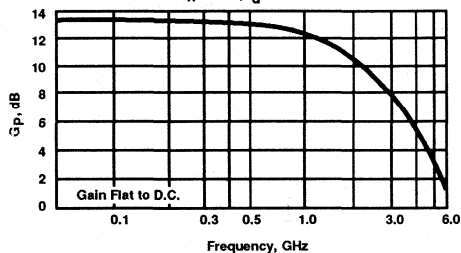

Electrical Specifications¹, $T_A = 25^\circ\text{C}$

Symbol	Parameters and Test Conditions: $I_d = 22\text{ mA}, Z_0 = 50\ \Omega$	Units	Min.	Typ.	Max.
G_p	Power Gain ($ S_{21} ^2$) $f = 0.1\text{ GHz}$ $f = 1.0\text{ GHz}$	dB		13.5 12.5	
ΔG_p	Gain Flatness $f = 0.1\text{ to }1.3\text{ GHz}$	dB		±0.7	
$f_3\text{ dB}$	3 dB Bandwidth	GHz		2.0	
VSWR	Input VSWR $f = 0.1\text{ to }2.5\text{ GHz}$			1.4:1	
	Output VSWR $f = 0.1\text{ to }2.5\text{ GHz}$			1.5:1	
$P_1\text{ dB}$	Output Power @ 1 dB Gain Compression $f = 1.0\text{ GHz}$	dBm		5.5	
NF	50 Ω Noise Figure $f = 1.0\text{ GHz}$	dB		5.0	
IP ₃	Third Order Intercept Point $f = 1.0\text{ GHz}$	dBm		19.0	
t_d	Group Delay $f = 1.0\text{ GHz}$	psec.		140	
V_d	Device Voltage	V	3.2	4.0	4.8
dV/dT	Device Voltage Temperature Coefficient	$\text{mV}/^\circ\text{C}$		-7.0	

Note: 1. The recommended operating current range for this device is 15 mA to 40 mA. Typical performance as a function of current is on the following page.

MSA-0785 MODAMP™ Cascadable Silicon Bipolar Monolithic Microwave Integrated Circuit Amplifiers

Absolute Maximum Ratings

Parameter	Absolute Maximum ¹
Device Current	60 mA
Power Dissipation ^{2,3}	275 mW
RF Input Power	+20 dBm
Junction Temperature	150°C
Storage Temperature	-65°C to 150°C

Thermal Resistance^{2,4}: $\theta_{jC} = 110^\circ\text{C/W}$

Notes:

- Permanent damage may occur if any of these limits are exceeded.
- TCASE = 25°C
- Derate at 9.1 mW/°C for TC > 120°C.
- See MEASUREMENTS section "Thermal Resistance" for more information.

Typical Performance, T_A = 25°C

(unless otherwise noted)

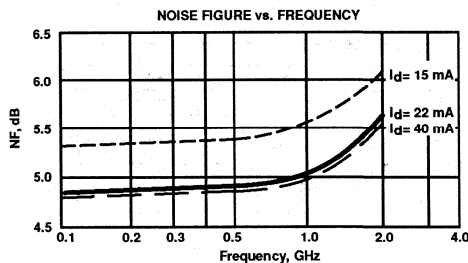
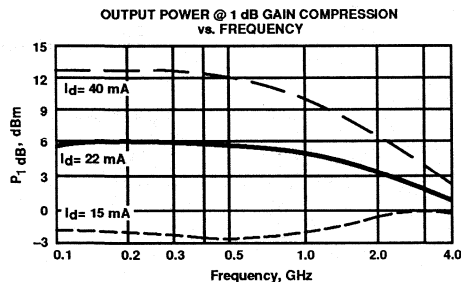
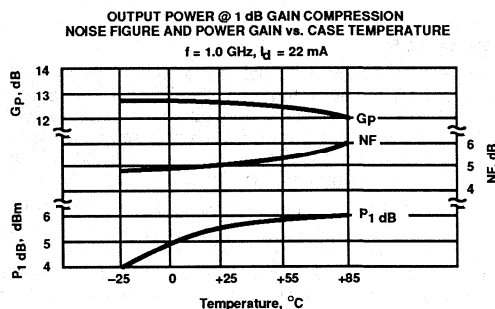
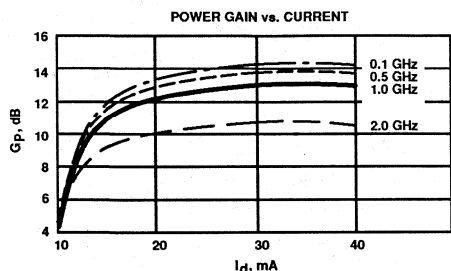
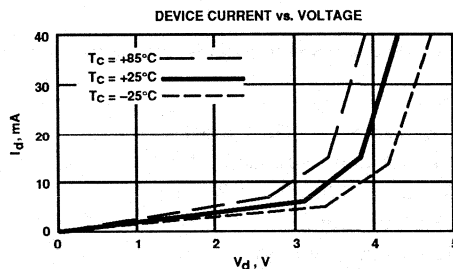

Typical Scattering Parameters: Z₀ = 50 Ω

T_A = 25°C, I_d = 22 mA

Freq. GHz	S ₁₁		S ₂₁			S ₁₂			S ₂₂	
	Mag	Ang	dB	Mag	Ang	dB	Mag	Ang	Mag	Ang
0.1	.05	166	13.5	4.73	174	-18.4	.120	1	.14	-11
0.2	.05	151	13.4	4.70	169	-18.3	.122	3	.14	-21
0.4	.04	115	13.3	4.63	158	-18.3	.121	6	.14	-40
0.6	.04	65	13.1	4.53	148	-18.0	.125	7	.16	-58
0.8	.05	26	12.9	4.41	138	-17.8	.129	9	.17	-71
1.0	.06	-5	12.6	4.25	127	-17.6	.132	10	.18	-84
1.5	.08	-51	11.6	3.82	104	-16.5	.149	12	.18	-109
2.0	.11	-99	10.5	3.33	82	-15.9	.161	11	.17	-126
2.5	.14	-127	9.3	2.91	68	-15.2	.174	13	.16	-134
3.0	.20	-154	7.9	2.48	52	-14.8	.183	7	.16	-139
3.5	.25	-173	6.7	2.16	37	-14.7	.184	5	.16	-132
4.0	.29	171	5.5	1.88	23	-14.8	.182	1	.18	-130
5.0	.35	139	3.5	1.50	-1	-14.3	.193	-6	.21	-133
6.0	.46	100	1.7	1.22	-26	-14.5	.189	-14	.20	-169

A model for this device is available in the DEVICE MODELS section.

Features

- Cascadable 50 Ω Gain Block
- Low Operating Voltage (4.0 V typical V_d)
- 3 dB Bandwidth: DC to 2.0 GHz
- 12.5 dB typical Gain at 1.0 GHz
- Unconditionally Stable ($k > 1$)
- Surface Mount Plastic Package
- Tape-and-Reel Packaging Option Available¹

Description

Avantek's MSA-0786 is a high performance silicon bipolar Monolithic Microwave Integrated Circuit (MMIC) housed in a low cost, surface mount plastic package. This MODAMP™ MMIC is designed for use as a general purpose 50 Ω gain block. Applications include narrow and broad band IF and RF amplifiers in commercial and industrial applications.

The MODAMP MSA-series is fabricated using a 10 GHz f_T , 25 GHz f_{MAX} silicon bipolar MMIC process which utilizes nitride self-alignment, ion implantation and gold metallization to achieve excellent uniformity, performance, and reliability. The use of an external bias resistor for temperature and current stability also allows bias flexibility.

Avantek 86 Plastic Package

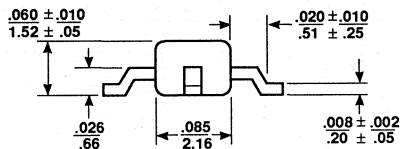
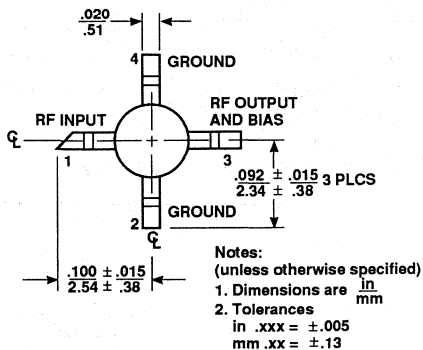

Typical Biasing Configuration

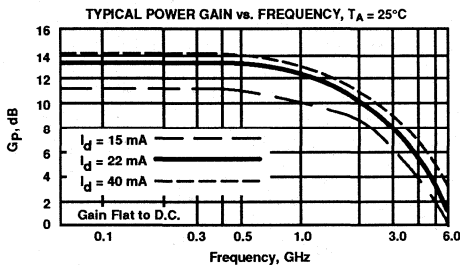
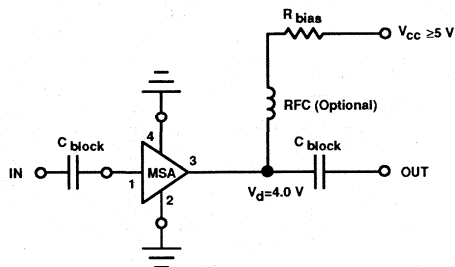

Electrical Specifications², $T_A = 25^\circ\text{C}$

Symbol	Parameters and Test Conditions: $I_d = 22 \text{ mA}$, $Z_0 = 50 \Omega$	Units	Min.	Typ.	Max.
G_p	Power Gain ($ S_{21} ^2$) $f = 0.1 \text{ GHz}$ $f = 1.0 \text{ GHz}$	dB	10.5	13.5 12.5	
ΔG_p	Gain Flatness $f = 0.1 \text{ to } 1.3 \text{ GHz}$	dB		± 0.7	
$f_3 \text{ dB}$	3 dB Bandwidth	GHz		2.0	
VSWR	Input VSWR $f = 0.1 \text{ to } 2.5 \text{ GHz}$			1.7:1	
	Output VSWR $f = 0.1 \text{ to } 2.5 \text{ GHz}$			1.7:1	
$P_1 \text{ dB}$	Output Power @ 1 dB Gain Compression $f = 1.0 \text{ GHz}$	dBm		5.5	
NF	50 Ω Noise Figure $f = 1.0 \text{ GHz}$	dB		5.0	
IP_3	Third Order Intercept Point $f = 1.0 \text{ GHz}$	dBm		19.0	
t_D	Group Delay $f = 1.0 \text{ GHz}$	psec.		150	
V_d	Device Voltage	V	3.2	4.0	4.8
dV/dT	Device Voltage Temperature Coefficient	mV/°C		-7.0	

Notes: 1. Refer to PACKAGING section "Tape-and-Reel Packaging for Surface Mount Semiconductors".
 2. The recommended operating current range for this device is 15 mA to 40 mA. Typical performance as a function of current is on the following page.

MSA-0786 MODAMP™ Cascadable Silicon Bipolar Monolithic Microwave Integrated Circuit Amplifiers

Absolute Maximum Ratings

Parameter	Absolute Maximum ¹
Device Current	60 mA
Power Dissipation ^{2,3}	275 mW
RF Input Power	+20 dBm
Junction Temperature	150°C
Storage Temperature	-65°C to 150°C

Thermal Resistance^{2,4}: $\theta_{jC} = 120^\circ\text{C/W}$

Notes:

- Permanent damage may occur if any of these limits are exceeded.
- $T_{\text{CASE}} = 25^\circ\text{C}$
- Derate at 8.3 mW/°C for $T_{\text{C}} > 117^\circ\text{C}$.
- See MEASUREMENTS section "Thermal Resistance" for more information.

Part Number Ordering Information

Part Number	Devices Per Reel	Reel Size
MSA-0786-TR1	1000	7"
MSA-0786-TR2	4000	13"

Typical Performance, $T_A = 25^\circ\text{C}$

(unless otherwise noted)

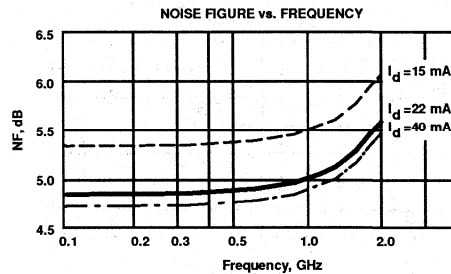
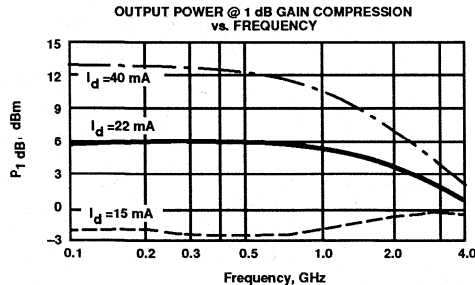
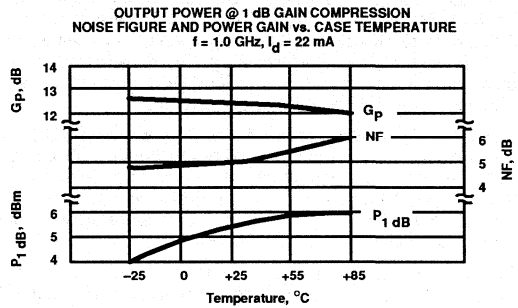
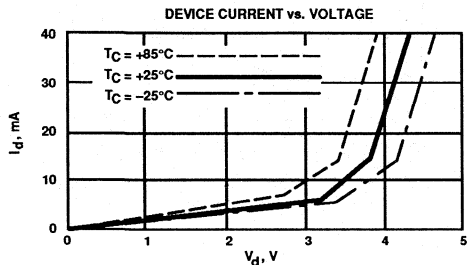

Typical Scattering Parameters: $Z_0 = 50 \Omega$

$T_A = 25^\circ\text{C}$, $I_d = 22 \text{ mA}$

Freq. GHz	S ₁₁		S ₂₁			S ₁₂			S ₂₂	
	Mag	Ang	dB	Mag	Ang	dB	Mag	Ang	Mag	Ang
0.1	.05	175	13.5	4.74	174	-18.7	.116	1	.14	-12
0.2	.05	174	13.4	4.71	169	-18.7	.117	3	.14	-22
0.4	.04	167	13.3	4.64	158	-18.4	.120	4	.15	-44
0.6	.04	175	13.1	4.52	148	-18.3	.122	7	.16	-65
0.8	.05	-156	12.9	4.39	138	-18.0	.126	8	.17	-84
1.0	.06	-134	12.6	4.25	127	-17.5	.134	10	.18	-102
1.5	.08	-142	11.6	3.79	103	-16.6	.148	9	.21	-139
2.0	.15	-159	10.5	3.34	80	-15.7	.164	7	.23	-164
2.5	.25	-176	9.2	2.89	63	-15.1	.176	5	.24	174
3.0	.33	166	7.8	2.45	44	-14.7	.185	1	.24	159
3.5	.41	150	6.5	2.11	27	-14.9	.179	-5	.24	149
4.0	.49	137	5.2	1.82	12	-15.1	.177	-9	.23	145
5.0	.60	116	3.0	1.41	-14	-15.4	.169	-14	.26	145

A model for this device is available in the DEVICE MODELS section.

Features

- Usable Gain to 6.0 GHz
- High Gain:
 32.5 dB typical at 0.1 GHz
 23.5 dB typical at 1.0 GHz
- Low Noise Figure:
 3.0 dB typical at 1.0 GHz

Description

Avantek's MSA-0800 is a high performance silicon bipolar Monolithic Microwave Integrated Circuit (MMIC) chip. This MODAMP™ MMIC is designed for use as a general purpose 50 Ω gain block above 0.5 GHz and can be used as a high gain transistor below this frequency. Typical applications include narrow and broad band IF and RF amplifiers in commercial, industrial and military applications.

The MODAMP MSA-series is fabricated using a 10 GHz f_T , 25 GHz f_{MAX} silicon bipolar MMIC process which utilizes nitride self-alignment, ion implantation and gold metallization to achieve excellent uniformity, performance, and reliability. The use of an external bias resistor for temperature and current stability also allows bias flexibility.

The recommended assembly procedure is gold-eutectic die attach at 400°C and either wedge or ball bonding using 0.7 mil gold wire. See APPLICATIONS section, "Chip Use".

Avantek Chip Outline¹

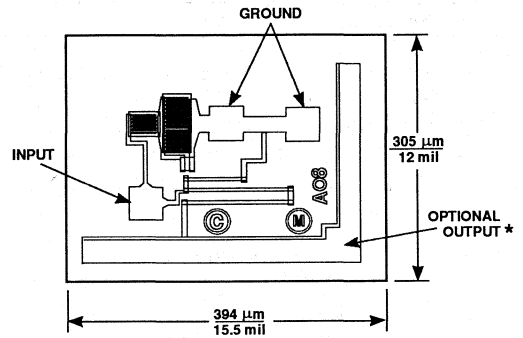

Unless otherwise specified, tolerances are $\pm 13 \mu\text{m} / \pm 0.5 \text{ mils}$.
 Chip thickness is $114 \mu\text{m} / 4.5 \text{ mil}$. Bond pads are $41 \mu\text{m} / 1.6 \text{ mil}$ typical on each side.

* Output contact is made by die attaching the backside of the die.

TYPICAL POWER GAIN vs. FREQUENCY
 $T_A = 25^\circ\text{C}$, $I_d = 36 \text{ mA}$

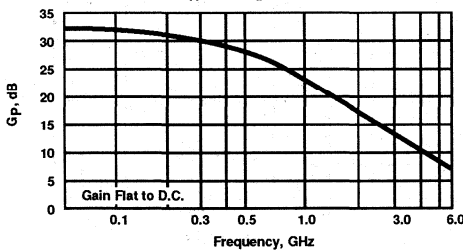

Typical Biasing Configuration

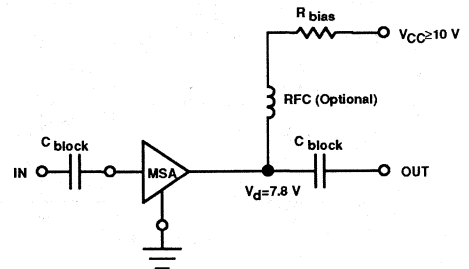

Electrical Specifications², $T_A = 25^\circ\text{C}$

Symbol	Parameters and Test Conditions ³ : $I_d = 36 \text{ mA}$, $Z_0 = 50 \Omega$	Units	Min.	Typ.	Max.
Gp	Power Gain ($ S_{21} ^2$)	$f = 0.1 \text{ GHz}$		32.5	
		$f = 1.0 \text{ GHz}$		23.5	
		$f = 4.0 \text{ GHz}$		11.0	
VSWR	Input VSWR	$f = 1.0 \text{ to } 3.0 \text{ GHz}$		2.0:1	
	Output VSWR	$f = 1.0 \text{ to } 3.0 \text{ GHz}$		1.9:1	
P1 dB	Output Power @ 1 dB Gain Compression,	$f = 1.0 \text{ GHz}$		12.5	
NF	50 Ω Noise Figure	$f = 1.0 \text{ GHz}$		3.0	
IP3	Third Order Intercept Point	$f = 1.0 \text{ GHz}$		27.0	
tD	Group Delay	$f = 1.0 \text{ GHz}$		125	
Vd	Device Voltage		7.0	7.8	8.4
dV/dT	Device Voltage Temperature Coefficient			-17.0	

Notes: 1. Refer to the APPLICATIONS section "MODAMP™ Silicon MMIC Chip Use" for additional information.

2. The recommended operating current range for this device is 20 mA to 40 mA. Typical performance as a function of current is on the following page.

3. RF performance of the chip is determined by packaging and testing 10 devices per wafer in a dual ground configuration.

MSA-0800 MODAMP™ Cascadable Silicon Bipolar Monolithic Microwave Integrated Circuit Amplifiers

Absolute Maximum Ratings

Parameter	Absolute Maximum ¹
Device Current	80 mA
Power Dissipation ^{2,3}	750 mW
RF Input Power	+20 dBm
Junction Temperature	200°C
Storage Temperature	200°C

Thermal Resistance^{2,4}: $\theta_{jC} = 70^\circ\text{C}/\text{W}$

Notes:

- Permanent damage may occur if any of these limits are exceeded.
- T_{MOUNTING SURFACE} = 25°C
- Derate at 14.3 mW/°C for T_{MOUNTING SURFACE} > 148°C.
- The small spot size of this technique results in a higher, though more accurate determination of θ_{jC} than do alternate methods. See MEASUREMENTS section "Thermal Resistance" for more information.

Part Number Ordering Information

Part Number	Devices Per Tray
MSA-0800-GP2	10
MSA-0800-GP4	100
MSA-0800-GP6	up to 300

Typical Performance, T_A = 25°C

(unless otherwise noted)

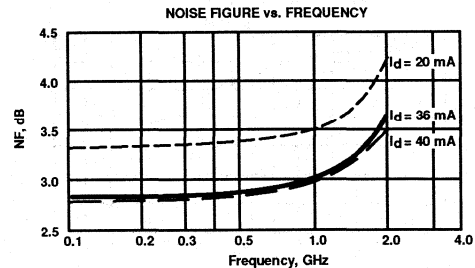
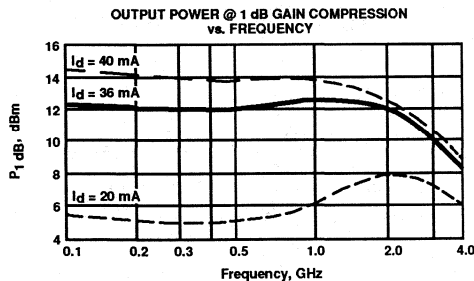
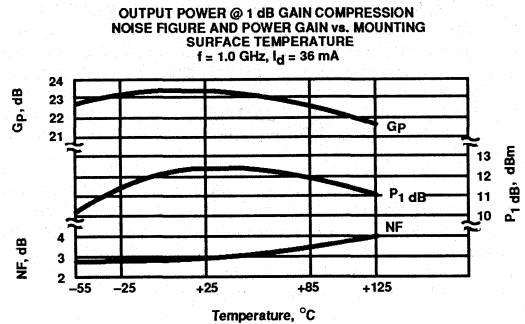
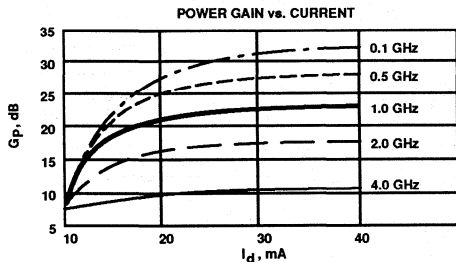

Typical Scattering Parameters⁴: Z₀ = 50 Ω

T_A = 25°C, I_d = 36 mA

Freq. GHz	S ₁₁		S ₂₁		S ₁₂			S ₂₂		k	
	Mag	Ang	dB	Mag	Ang	dB	Mag	Ang			
0.1	.65	-17	32.6	42.50	163	-36.9	.014	39	.64	-20	0.80
0.2	.61	-31	31.7	38.59	148	-34.1	.020	47	.59	-39	0.68
0.4	.50	-54	29.6	30.22	126	-31.0	.028	52	.49	-68	0.63
0.6	.43	-70	27.5	23.64	113	-28.5	.038	52	.40	-90	0.69
0.8	.38	-81	25.6	19.05	103	-26.7	.046	53	.35	-106	0.75
1.0	.34	-95	24.2	16.27	93	-25.4	.054	55	.30	-120	0.80
1.5	.31	-110	20.9	11.12	78	-23.6	.066	53	.23	-142	0.88
2.0	.32	-124	18.3	8.22	66	-22.6	.075	53	.17	-158	0.98
2.5	.33	-129	16.3	6.52	61	-20.7	.092	57	.13	-162	1.00
3.0	.34	-138	14.4	5.24	54	-20.3	.097	54	.07	-165	1.11
3.5	.36	-146	12.8	4.36	45	-19.0	.112	50	.07	-140	1.11
4.0	.36	-155	11.3	3.68	37	-18.3	.122	49	.10	-96	1.16
5.0	.35	177	8.7	2.73	23	-17.2	.138	43	.15	-75	1.28
6.0	.43	150	6.3	2.07	10	-16.6	.148	35	.15	-81	1.40

Note: 4. S-parameters are de-embedded from 70 mil package measured data using the package model found in the DEVICE MODELS section.

Features

- Usable Gain to 6.0 GHz
- High Gain: 32.5 dB typical at 0.1 GHz
23.0 dB typical at 1.0 GHz
- Low Noise Figure: 3.0 dB typical at 1.0 GHz
- Cost Effective Ceramic Microstrip Package

Description

Avantek's MSA-0835 is a high performance silicon bipolar Monolithic Microwave Integrated Circuit (MMIC) housed in a cost effective, microstrip package. This MODAMP™ MMIC is designed for use as a general purpose 50 Ω gain block above 0.5 GHz and can be used as a high gain transistor below this frequency. Typical applications include narrow and moderate band IF and RF amplifiers in commercial and industrial applications.

The MODAMP MSA-series is fabricated using a 10 GHz f_T , 25 GHz f_{MAX} silicon bipolar MMIC process which utilizes nitride self-alignment, ion implantation and gold metallization to achieve excellent uniformity, performance, and reliability. The use of an external bias resistor for temperature and current stability also allows bias flexibility.

Avantek 35 micro-X Package¹

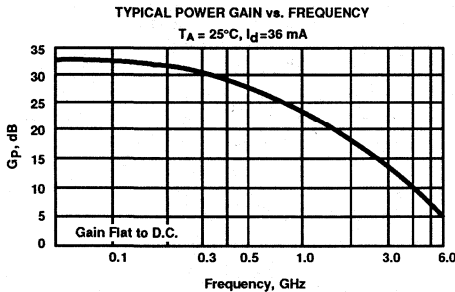
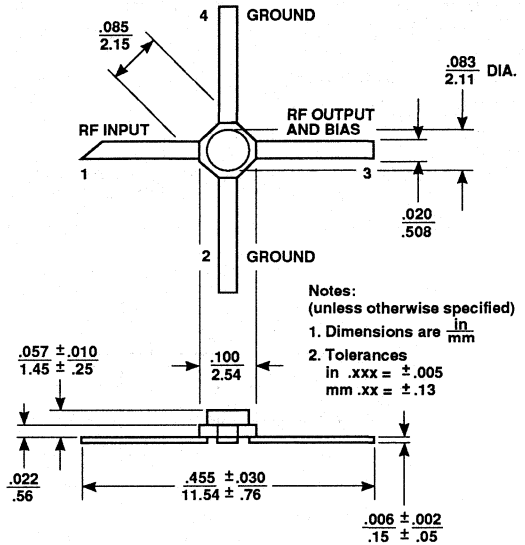

Typical Biasing Configuration

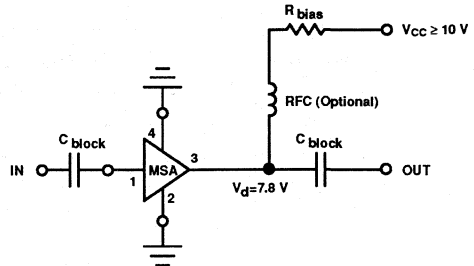

Electrical Specifications², TA = 25°C

Symbol	Parameters and Test Conditions: $I_d = 36 \text{ mA}$, $Z_0 = 50 \Omega$	Units	Min.	Typ.	Max.
Gp	Power Gain ($ S_{21} ^2$) $f = 0.1 \text{ GHz}$ $f = 1.0 \text{ GHz}$ $f = 4.0 \text{ GHz}$	dB	22.0	32.5 23.0 10.5	25.0
VSWR	Input VSWR $f = 1.0 \text{ to } 3.0 \text{ GHz}$			2.0:1	
	Output VSWR $f = 1.0 \text{ to } 3.0 \text{ GHz}$			1.5:1	
P1 dB	Output Power @ 1 dB Gain Compression $f = 1.0 \text{ GHz}$	dBm		12.5	
NF	50 Ω Noise Figure $f = 1.0 \text{ GHz}$	dB		3.0	
IP3	Third Order Intercept Point $f = 1.0 \text{ GHz}$	dBm		27.0	
tD	Group Delay $f = 1.0 \text{ GHz}$	psec.		125	
Vd	Device Voltage	V	7.0	7.8	8.4
dV/dT	Device Voltage Temperature Coefficient	mV/°C		-17.0	

Notes: 1. Short leaded 36 package available upon request.

2. The recommended operating current range for this device is 20 mA to 40 mA. Typical performance as a function of current is on the following page.

MSA-0835 MODAMP™ Cascadable Silicon Bipolar Monolithic Microwave Integrated Circuit Amplifiers

Absolute Maximum Ratings

Parameter	Absolute Maximum ¹
Device Current	80 mA
Power Dissipation ^{2,3}	750 mW
RF Input Power	+20 dBm
Junction Temperature	200°C
Storage Temperature ⁴	-65°C to 200°C

Thermal Resistance^{2,5}: $\theta_{jc} = 175^\circ\text{C/W}$

Notes:

- Permanent damage may occur if any of these limits are exceeded.
- TCASE = 25°C
- Derate at 5.7 mW/°C for $T_C > 69^\circ\text{C}$.
- Storage above +150°C may tarnish the leads of this package making it difficult to solder into a circuit.
- The small spot size of this technique results in a higher, though more accurate determination of θ_{jc} than do alternate methods. See MEASUREMENTS section "Thermal Resistance" for more information.

Typical Performance, $T_A = 25^\circ\text{C}$

(unless otherwise noted)

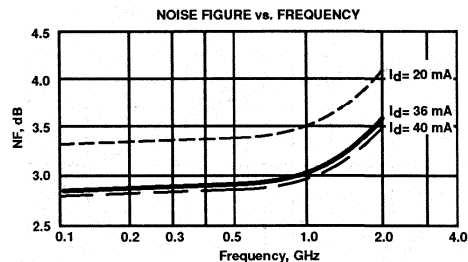
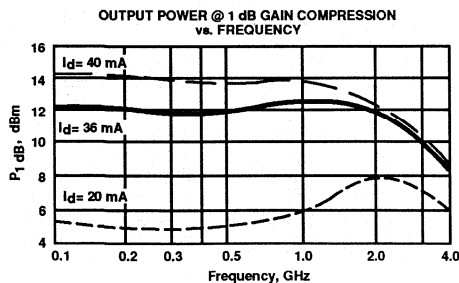
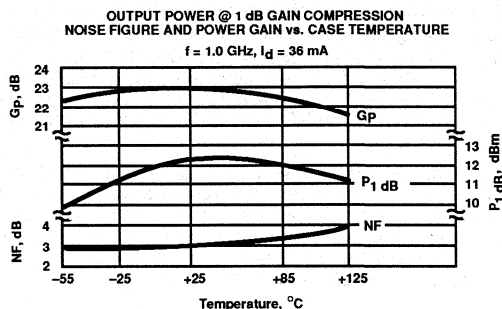
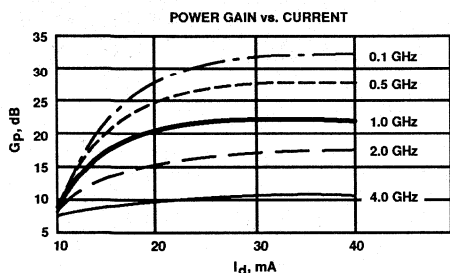
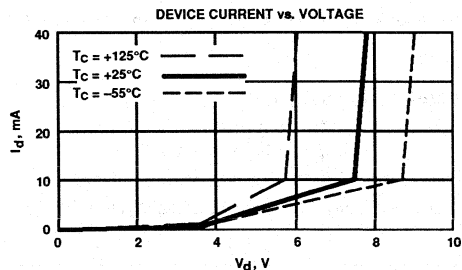

Typical Scattering Parameters: $Z_0 = 50 \Omega$

$T_A = 25^\circ\text{C}, I_d = 36 \text{ mA}$

Freq. GHz	S_{11}		S_{21}			S_{12}			S_{22}		k
	Mag	Ang	dB	Mag	Ang	dB	Mag	Ang	Mag	Ang	
0.1	.63	-17	32.5	42.02	161	-37.7	.013	55	.63	-19	0.72
0.2	.58	-33	31.5	37.52	145	-33.7	.021	47	.56	-37	0.73
0.4	.49	-56	29.1	28.50	119	-29.7	.033	54	.42	-66	0.72
0.6	.40	-70	26.7	21.54	103	-27.9	.040	55	.32	-84	0.78
0.8	.35	-80	24.6	17.01	92	-26.0	.050	53	.24	-98	0.85
1.0	.33	-89	22.9	13.98	82	-24.9	.057	52	.18	-107	0.89
1.5	.30	-111	19.5	9.45	64	-22.1	.079	51	.09	-126	0.95
2.0	.30	-133	16.9	7.03	48	-20.2	.098	44	.07	-141	0.99
2.5	.32	-150	14.9	5.53	39	-19.2	.110	42	.06	-166	1.04
3.0	.34	-170	13.2	4.56	26	-18.3	.122	36	.06	-106	1.06
3.5	.38	175	11.7	3.86	14	-17.5	.133	32	.08	-100	1.08
4.0	.39	162	10.5	3.33	2	-16.7	.146	27	.12	-101	1.08
5.0	.41	132	7.9	2.47	-21	-15.6	.165	19	.21	-113	1.10
6.0	.52	95	5.8	1.94	-45	-14.6	.187	7	.20	-149	1.05

A model for this device is available in the DEVICE MODELS section.

Features

- Usable Gain to 6.0 GHz
- High Gain: 32.5 dB typical at 0.1 GHz
23.5 dB typical at 1.0 GHz
- Low Noise Figure: 3.0 dB typical at 1.0 GHz
- Hermetic Gold-ceramic Microstrip Package

Description

Avantek's MSA-0870 is a high performance silicon bipolar Monolithic Microwave Integrated Circuit (MMIC) housed in a hermetic, high reliability package. This MODAMP™ MMIC is designed for use as a general purpose 50 Ω gain block above 0.5 GHz and can be used as a high gain transistor below this frequency. Typical applications include narrow and moderate band IF and RF amplifiers in industrial and military applications.

The MODAMP MSA-series is fabricated using a 10 GHz f_t , 25 GHz f_{MAX} silicon bipolar MMIC process which utilizes nitride self-alignment, ion implantation and gold metallization to achieve excellent uniformity, performance, and reliability. The use of an external bias resistor for temperature and current stability also allows bias flexibility.

Avantek 70 mil Package

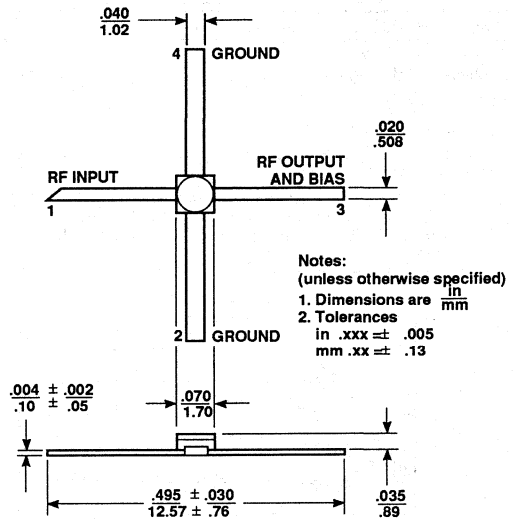

TYPICAL POWER GAIN vs. FREQUENCY
 $T_A = 25^\circ\text{C}, I_d = 36\text{ mA}$

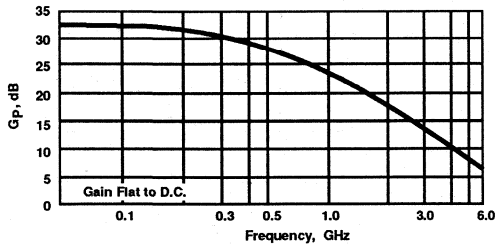

Typical Biasing Configuration

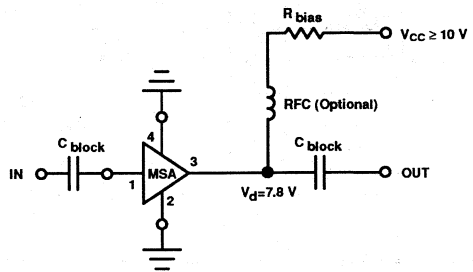

Electrical Specifications¹, $T_A = 25^\circ\text{C}$

Symbol	Parameters and Test Conditions: $I_d = 36\text{ mA}, Z_o = 50\ \Omega$	Units	Min.	Typ.	Max.
Gp	Power Gain ($ S_{21} ^2$)	$f = 0.1\text{ GHz}$		32.5	
		$f = 1.0\text{ GHz}$	22.0	23.5	25.0
		$f = 4.0\text{ GHz}$	10.0	11.0	12.0
VSWR	Input VSWR	$f = 1.0\text{ to }3.0\text{ GHz}$		2.0:1	
	Output VSWR	$f = 1.0\text{ to }3.0\text{ GHz}$		1.9:1	
P ₁ dB	Output Power @ 1 dB Gain Compression	$f = 1.0\text{ GHz}$		12.5	
NF	50 Ω Noise Figure	$f = 1.0\text{ GHz}$		3.0	
IP ₃	Third Order Intercept Point	$f = 1.0\text{ GHz}$		27.0	
t _D	Group Delay	$f = 1.0\text{ GHz}$		125	
V _d	Device Voltage		7.0	7.8	8.4
dV/dT	Device Voltage Temperature Coefficient			-17.0	

Note: 1. The recommended operating current range for this device is 20 mA to 40 mA. Typical performance as a function of current is on the following page.

MSA-0870 MODAMP™ Cascadable Silicon Bipolar Monolithic Microwave Integrated Circuit Amplifiers

Absolute Maximum Ratings

Parameter	Absolute Maximum ¹
Device Current	80 mA
Power Dissipation ^{2,3}	750 mW
RF Input Power	+20 dBm
Junction Temperature	200°C
Storage Temperature	-65°C to 200°C
Thermal Resistance ^{2,4} : $\theta_{jc} = 150^\circ\text{C}/\text{W}$	

Notes:

- Permanent damage may occur if any of these limits are exceeded.
- T_{case} = 25°C.
- Derate at 6.7 mW/°C for T_C > 88°C.
- The small spot size of this technique results in a higher, though more accurate determination of θ_{jc} than do alternate methods. See MEASUREMENTS section "Thermal Resistance" for more information.

Typical Performance, T_A = 25°C

(unless otherwise noted)

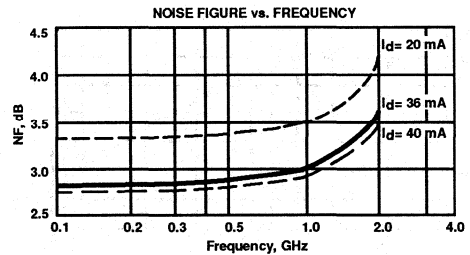
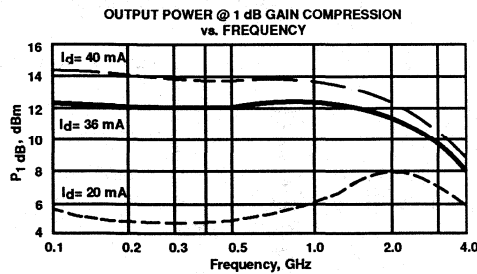
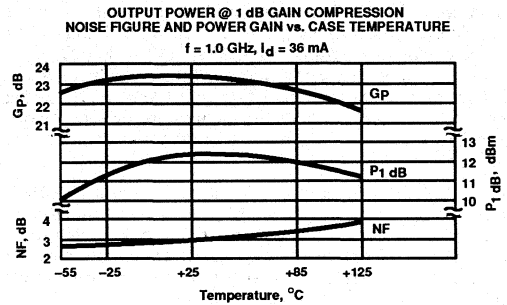
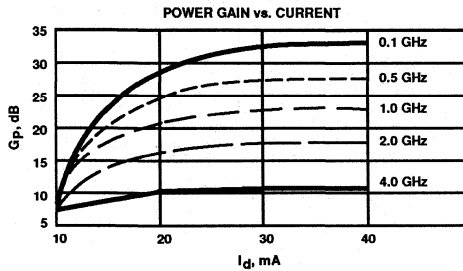
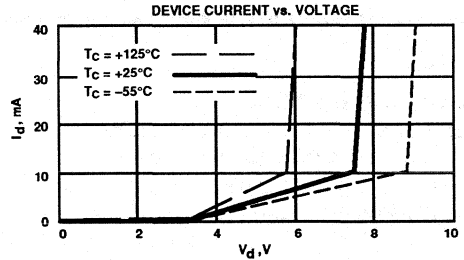

Typical Scattering Parameters: Z₀ = 50 Ω

T_A = 25°C, I_d = 36 mA

Freq. MHz	S ₁₁		S ₂₁			S ₁₂			S ₂₂			k
	Mag	Ang	dB	Mag	Ang	dB	Mag	Ang	Mag	Ang		
0.1	.65	-19	32.5	42.04	161	-36.3	.015	40	.64	-22	0.78	
0.2	.60	-35	31.5	37.54	145	-33.7	.021	47	.58	-43	0.66	
0.4	.48	-60	29.1	28.49	122	-30.5	.030	51	.47	-74	0.64	
0.6	.40	-76	26.8	21.90	108	-28.0	.040	50	.38	-97	0.72	
0.8	.35	-88	24.9	17.48	97	-26.2	.049	50	.33	-113	0.78	
1.0	.32	-102	23.4	14.85	87	-24.9	.057	51	.28	-128	0.83	
1.5	.29	-118	20.1	10.14	70	-23.0	.071	47	.22	-151	0.91	
2.0	.30	-133	17.6	7.55	56	-21.9	.081	45	.16	-167	0.98	
2.5	.31	-139	15.6	6.01	49	-20.0	.100	46	.12	-172	1.02	
3.0	.32	-149	13.8	4.87	39	-19.5	.106	41	.07	-170	1.11	
3.5	.34	-158	12.2	4.09	28	-18.4	.121	35	.07	-143	1.12	
4.0	.34	-168	10.8	3.48	17	-17.7	.131	31	.12	-112	1.16	
5.0	.33	161	8.4	2.63	-3	-16.6	.147	21	.19	-103	1.26	
6.0	.39	128	6.2	2.04	-22	-16.2	.155	10	.21	-115	1.36	

A model for this device is available in the DEVICE MODELS section.

Features

- Usable Gain to 6.0 GHz
- High Gain: 32.5 dB typical at 0.1 GHz
 22.5 dB typical at 1.0 GHz
- Low Noise Figure: 3.3 dB typical at 1.0 GHz
- Low Cost Plastic Package

Description

Avantek's MSA-0885 is a high performance silicon bipolar Monolithic Microwave Integrated Circuit (MMIC) housed in a low cost plastic package. This MODAMP™ MMIC is designed for use as a general purpose 50 Ω gain block above 0.5 GHz and can be used as a high gain transistor below this frequency. Typical applications include narrow and moderate band IF and RF amplifiers in commercial and industrial applications.

The MODAMP MSA-series is fabricated using a 10 GHz f_T , 25 GHz f_{MAX} silicon bipolar MMIC process which utilizes nitride self-alignment, ion implantation and gold metallization to achieve excellent uniformity, performance, and reliability. The use of an external bias resistor for temperature and current stability also allows bias flexibility.

Avantek 85 Plastic Package

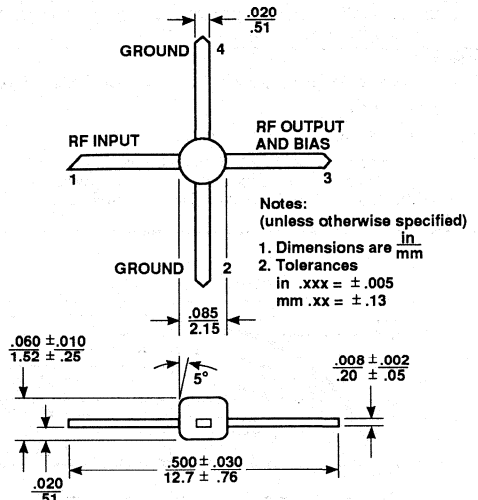

TYPICAL POWER GAIN vs. FREQUENCY

$T_A = 25^\circ\text{C}$, $I_d = 36\text{ mA}$

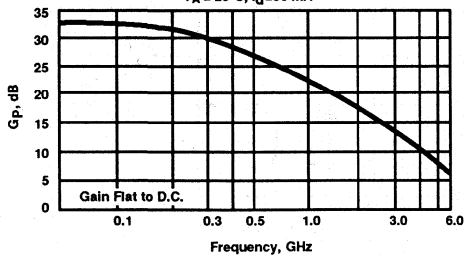

Typical Biasing Configuration

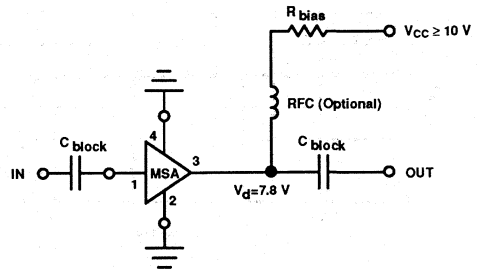

Electrical Specifications¹, $T_A = 25^\circ\text{C}$

Symbol	Parameters and Test Conditions: $I_d = 36\text{ mA}$, $Z_0 = 50\ \Omega$	Units	Min.	Typ.	Max.
Gp	Power Gain ($ S_{21} ^2$) $f = 0.1\text{ GHz}$ $f = 1.0\text{ GHz}$	dB	21.0	32.5 22.5	
VSWR	Input VSWR $f = 0.1\text{ to }3.0\text{ GHz}$			1.9:1	
	Output VSWR $f = 0.1\text{ to }3.0\text{ GHz}$			1.6:1	
P ₁ dB	Output Power @ 1 dB Gain Compression $f = 1.0\text{ GHz}$	dBm		12.5	
NF	50 Ω Noise Figure $f = 1.0\text{ GHz}$	dB		3.3	
IP ₃	Third Order Intercept Point $f = 1.0\text{ GHz}$	dBm		27.0	
t _D	Group Delay $f = 1.0\text{ GHz}$	psec.		125	
V _d	Device Voltage	V	6.2	7.8	9.4
dV/dT	Device Voltage Temperature Coefficient	mV/°C		-17.0	

Note: 1. The recommended operating current range for this device is 20 mA to 40 mA. Typical performance as a function of current is on the following page.

MSA-0885 MODAMP™ Cascadable Silicon Bipolar Monolithic Microwave Integrated Circuit Amplifiers

Absolute Maximum Ratings

Parameter	Absolute Maximum ¹
Device Current	65 mA
Power Dissipation ^{2,3}	500 mW
RF Input Power	+20 dBm
Junction Temperature	150°C
Storage Temperature	-65°C to 150°C

Thermal Resistance^{2,4}: $\theta_{jc} = 130^\circ\text{C/W}$

Notes:

- Permanent damage may occur if any of these limits are exceeded.
- T_{CASE} = 25°C
- Derate at 7.7 mW/°C for T_C > 85°C.
- See MEASUREMENTS section "Thermal Resistance" for more information.

Typical Performance, T_A = 25°C

(unless otherwise noted)

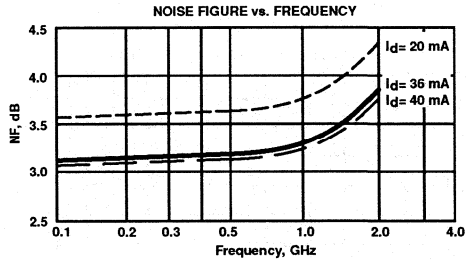
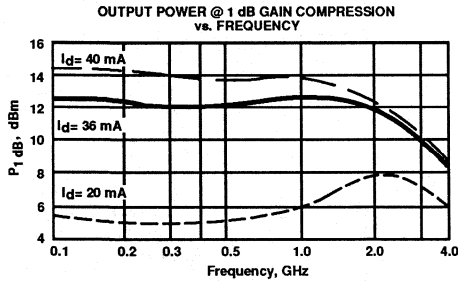
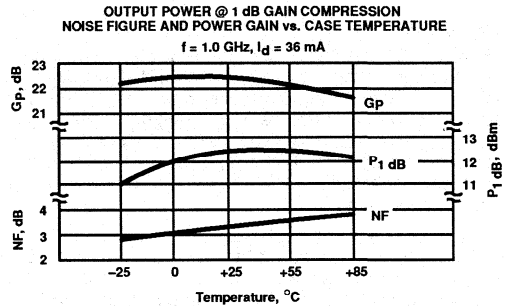
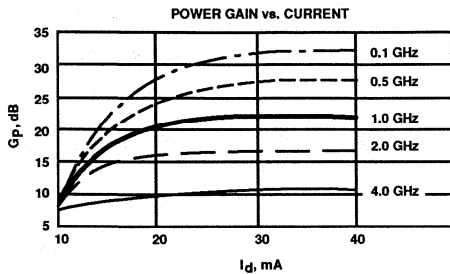
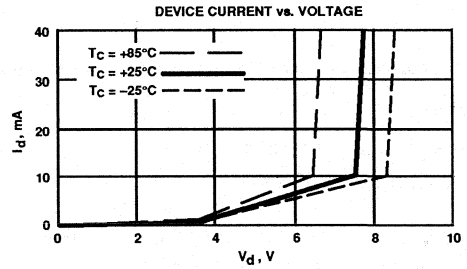

Typical Scattering Parameters: Z₀ = 50 Ω

Freq. GHz	S ₁₁		S ₂₁			S ₁₂			S ₂₂		k
	Mag	Ang	dB	Mag	Ang	dB	Mag	Ang	Mag	Ang	
0.1	.64	-21	32.5	42.29	160	-36.5	.015	40	.61	-24	0.78
0.2	.58	-39	31.3	36.89	144	-32.8	.023	50	.54	-45	0.67
0.4	.44	-65	28.7	27.20	120	-29.4	.034	54	.42	-77	0.69
0.6	.36	-82	26.3	20.57	106	-27.2	.044	53	.33	-98	0.77
0.8	.31	-95	24.3	16.31	96	-25.2	.055	53	.28	-115	0.83
1.0	.27	-105	22.5	13.36	87	-24.2	.061	51	.25	-129	0.87
1.5	.24	-125	19.3	9.24	71	-21.4	.085	50	.18	-153	0.96
2.0	.26	-147	16.7	6.82	56	-19.7	.103	47	.15	-173	0.98
2.5	.29	-159	14.9	5.57	48	-18.4	.120	44	.12	-180	1.00
3.0	.34	-175	13.1	4.51	37	-17.7	.130	42	.09	-165	1.03
3.5	.38	-172	11.6	3.80	25	-16.9	.144	37	.06	-172	1.04
4.0	.42	-161	10.1	3.21	14	-16.3	.153	33	.04	-139	1.06
5.0	.48	-135	7.7	2.43	-7	-15.6	.167	24	.09	-90	1.09
6.0	.60	-102	5.5	1.88	-29	-14.9	.179	17	.08	-140	1.06

A model for this device is available in the DEVICE MODELS section.

Features

- Usable Gain to 5.5 GHz
- High Gain: 32.5 dB typical at 0.1 GHz
22.5 dB typical at 1.0 GHz
- Low Noise Figure: 3.3 dB typical at 1.0 GHz
- Surface Mount Plastic Package
- Tape-and-Reel Packaging Option Available¹

Description

Avantek's MSA-0886 is a high performance silicon bipolar Monolithic Microwave Integrated Circuit (MMIC) housed in a low cost, surface mount plastic package. This MODAMP™ MMIC is designed for use as a general purpose 50 Ω gain block above 0.5 GHz and can be used as a high gain transistor below this frequency. Typical applications include narrow and moderate band IF and RF amplifiers in commercial and industrial applications.

The MODAMP MSA-series is fabricated using a 10 GHz f_T , 25 GHz f_{MAX} silicon bipolar MMIC process which utilizes nitride self-alignment, ion implantation and gold metallization to achieve excellent uniformity, performance, and reliability. The use of an external bias resistor for temperature and current stability also allows bias flexibility.

Avantek 86 Plastic Package

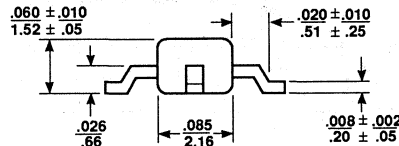
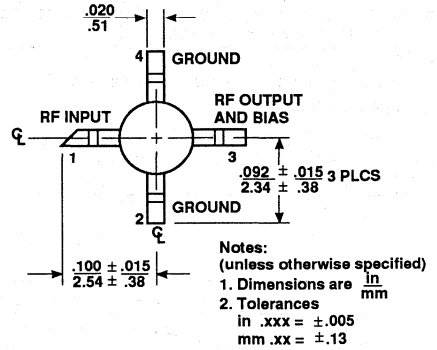

Typical Biasing Configuration

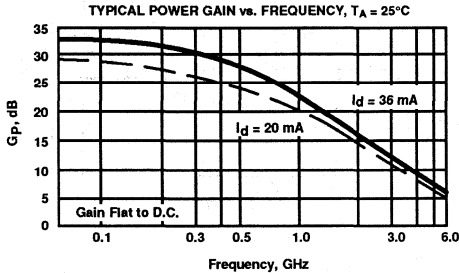
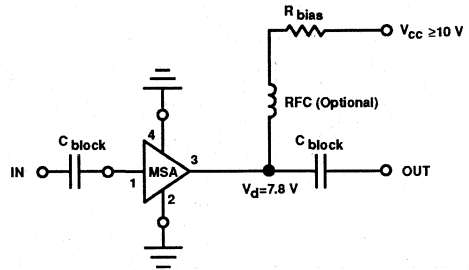

Electrical Specifications², TA = 25°C

Symbol	Parameters and Test Conditions: $I_d = 36$ mA, $Z_0 = 50$ Ω	Units	Min.	Typ.	Max.
GP	Power Gain ($ S_{21} ^2$) $f = 0.1$ GHz $f = 1.0$ GHz	dB	20.5	32.5 22.5	
VSWR	Input VSWR $f = 0.1$ to 3.0 GHz			2.1:1	
	Output VSWR $f = 0.1$ to 3.0 GHz			1.9:1	
P_1 dB	Output Power @ 1 dB Gain Compression $f = 1.0$ GHz	dBm		12.5	
NF	50 Ω Noise Figure $f = 1.0$ GHz	dB		3.3	
IP_3	Third Order Intercept Point $f = 1.0$ GHz	dBm		27.0	
t_D	Group Delay $f = 1.0$ GHz	psec.		140	
V_d	Device Voltage	V	6.2	7.8	9.4
dV/dT	Device Voltage Temperature Coefficient	mV/°C		-17.0	

Notes: 1. Refer to PACKAGING section "Tape-and-Reel Packaging for Surface Mount Semiconductors".
 2. The recommended operating current range for this device is 20 mA to 40 mA. Typical performance as a function of current is on the following page.

MSA-0886 MODAMP™ Cascadable Silicon Bipolar Monolithic Microwave Integrated Circuit Amplifiers

Absolute Maximum Ratings

Parameter	Absolute Maximum ¹
Device Current	65 mA
Power Dissipation ^{2,3}	500 mW
RF Input Power	+20 dBm
Junction Temperature	150°C
Storage Temperature	-65°C to 150°C

Thermal Resistance^{2,4}: $\theta_{JC} = 140^\circ\text{C/W}$

Notes:

1. Permanent damage may occur if any of these limits are exceeded.
2. T_{case} = 25°C
3. Derate at 7.1 mW/°C for T_C > 80°C.
4. See MEASUREMENTS section "Thermal Resistance" for more information.

Part Number Ordering Information

Part Number	Devices Per Reel	Reel Size
MSA-0886-TR1	1000	7"
MSA-0886-TR2	4000	13"

Typical Performance, T_A = 25°C

(unless otherwise noted)

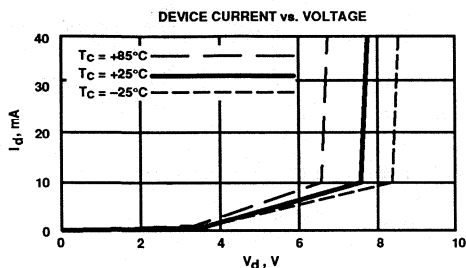

OUTPUT POWER @ 1 dB GAIN COMPRESSION
NOISE FIGURE AND POWER GAIN vs. CASE TEMPERATURE
f = 1.0 GHz, I_d = 36 mA

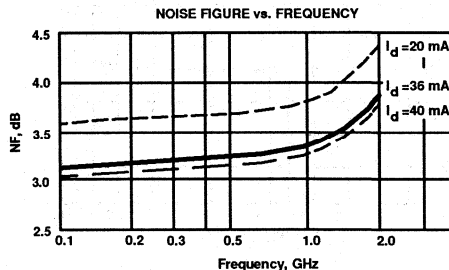
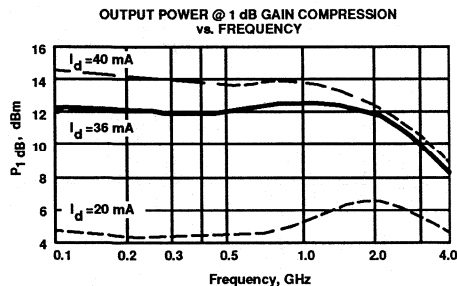
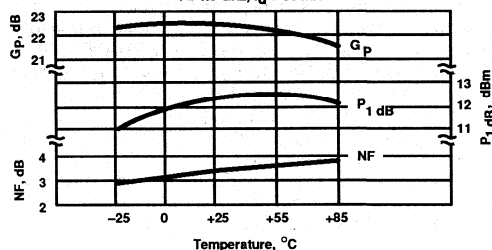

Typical Scattering Parameters: Z₀ = 50 Ω

T_A = 25°C, I_d = 36 mA

Freq. GHz	S ₁₁			S ₂₁			S ₁₂			S ₂₂			k
	Mag	Ang	dB	Mag	Ang	dB	Mag	Ang	dB	Mag	Ang		
0.1	.63	-22	32.5	42.12	160	-36.7	.015	54	.62	-24	0.68		
0.2	.56	-41	31.3	36.68	143	-33.9	.020	50	.55	-46	0.64		
0.4	.43	-69	28.6	26.94	119	-29.1	.035	52	.43	-79	0.69		
0.6	.35	-88	26.4	20.89	104	-27.0	.045	49	.34	-103	0.77		
0.8	.30	-104	24.2	16.21	93	-25.3	.054	50	.29	-124	0.83		
1.0	.27	-116	22.4	13.20	83	-24.2	.062	49	.26	-139	0.87		
1.5	.27	-144	19.2	9.15	65	-21.6	.083	46	.23	-172	0.93		
2.0	.31	-166	16.7	6.84	49	-19.5	.105	41	.22	163	0.96		
2.5	.35	178	14.8	5.50	38	-17.9	.128	36	.21	149	0.96		
3.0	.40	162	12.9	4.41	25	-17.4	.135	30	.20	132	1.01		
3.5	.45	149	11.4	3.72	13	-16.8	.145	25	.19	124	1.02		
4.0	.51	137	9.9	3.14	1	-16.1	.157	19	.18	121	1.01		
5.0	.61	116	7.3	2.31	-22	-15.7	.164	10	.17	130	1.00		
6.0	.68	100	4.6	1.69	-42	-15.2	.173	4	.23	143	0.95		

A model for this device is available in the DEVICE MODELS section.

Features

- **Broadband, Minimum Ripple Cascadable 50 Ω Gain Block**
- **8.0 ± 0.2 dB typical Gain Flatness from 0.1 to 4.0 GHz**
- **3 dB Bandwidth: 0.1 to 6.0 GHz**
- **Low VSWR: ≤ 1.5:1 from 0.1 to 4.0 GHz**
- **11.5 dBm typical P_{1 dB} at 1.0 GHz**
- **Hermetic Gold-ceramic Microstrip Package**

Description

Avantek's MSA-0910 is a high performance silicon bipolar Monolithic Microwave Integrated Circuit (MMIC) housed in a hermetic, high reliability package. This MODAMP™ MMIC is designed for very wide bandwidth industrial and military applications that require flat gain and low VSWR. The MODAMP MSA-series is fabricated using a 10 GHz f_T , 25 GHz f_{MAX} silicon bipolar MMIC process which utilizes nitride self-alignment, ion implantation and gold metallization to achieve excellent uniformity, performance, and reliability. The use of an external bias resistor for temperature and current stability also allows bias flexibility.

Avantek 100 mil Package

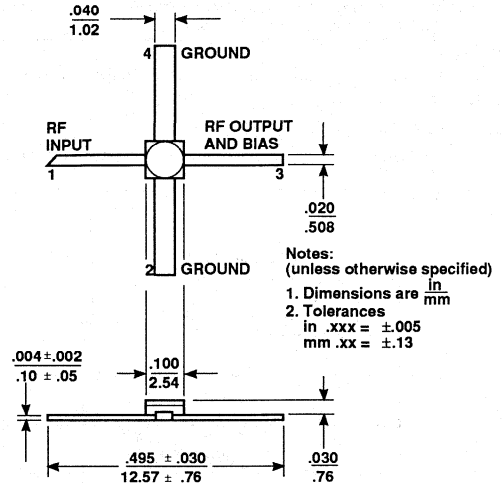

TYPICAL POWER GAIN vs. FREQUENCY
 $T_A = 25^\circ\text{C}, I_d = 35\text{ mA}$

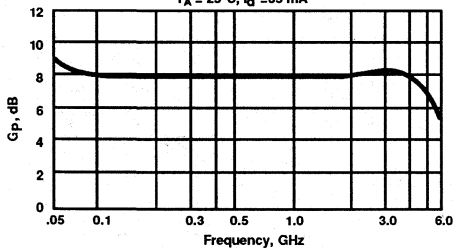

Typical Biasing Configuration

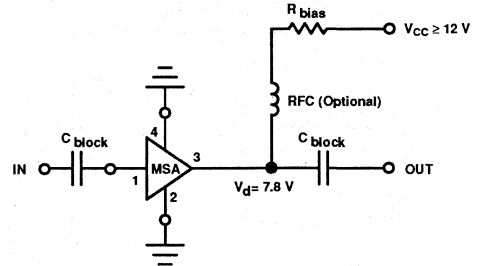

Electrical Specifications¹, $T_A = 25^\circ\text{C}$

Symbol	Parameters and Test Conditions: $I_d = 35\text{ mA}, Z_0 = 50\ \Omega$	Units	Min.	Typ.	Max.
G _P	Power Gain ($ S_{21} ^2$) $f = 0.1\text{ GHz}$	dB	7.0	8.0	9.0
ΔG_P	Gain Flatness $f = 0.1\text{ to }4.0\text{ GHz}$	dB		±0.2	±0.5
$f_3\text{ dB}$	3 dB Bandwidth ²	GHz		6.0	
VSWR	Input VSWR $f = 0.1\text{ to }4.0\text{ GHz}$			1.3:1	
	Output VSWR $f = 0.1\text{ to }4.0\text{ GHz}$			1.5:1	
P _{1 dB}	Output Power @ 1 dB Gain Compression $f = 1.0\text{ GHz}$ $f = 4.0\text{ GHz}$	dBm		11.5 6.5	
NF	50 Ω Noise Figure $f = 1.0\text{ GHz}$ $f = 4.0\text{ GHz}$	dB		6.0 6.5	
IP ₃	Third Order Intercept Point $f = 1.0\text{ GHz}$	dBm		23.0	
t _D	Group Delay $f = 1.0\text{ GHz}$	psec.		100	
V _d	Device Voltage	V	7.0	7.8	8.6
dV/dT	Device Voltage Temperature Coefficient	mV/°C		-16.0	

Notes: 1. The recommended operating current range for this device is 25 mA to 45 mA. Typical performance as a function of current is on the following page.
 2. Referenced from 0.1 GHz Gain (G_P).

MSA-0910 MODAMP™ Cascadable Silicon Bipolar Monolithic Microwave Integrated Circuit Amplifiers

Absolute Maximum Ratings

Parameter	Absolute Maximum ¹
Device Current	80 mA
Power Dissipation ^{2,3}	750 mW
RF Input Power	+20 dBm
Junction Temperature	200°C
Storage Temperature	-65°C to 200°C

Thermal Resistance^{2,4}: $\theta_{JC} = 145^\circ\text{C/W}$

Notes:

- Permanent damage may occur if any of these limits are exceeded.
- TCASE = 25°C
- Derate at 6.9 mW/°C for TC > 91°C.
- The small spot size of this technique results in a higher, though more accurate, determination of θ_{JC} than do alternate methods. See MEASUREMENTS section "Thermal Resistance" for more information.

Typical Performance, T_A = 25°C

(unless otherwise noted)

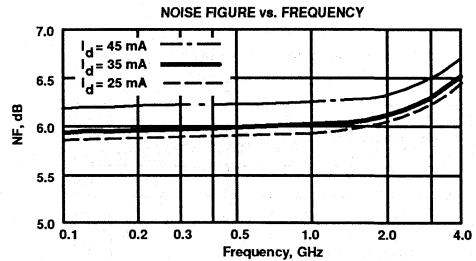
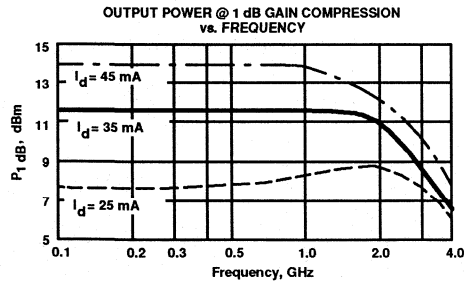
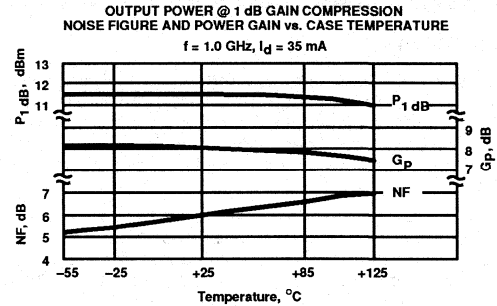
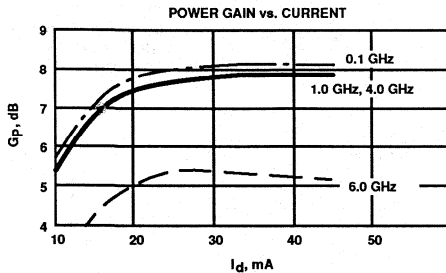
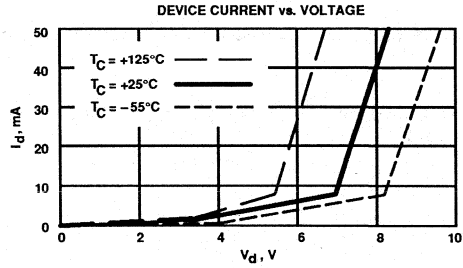

Typical Scattering Parameters: Z₀ = 50 Ω

T_A = 25°C, I_d = 35 mA

Freq. GHz	S ₁₁		S ₂₁			S ₁₂			S ₂₂		k
	Mag	Ang	dB	Mag	Ang	dB	Mag	Ang	Mag	Ang	
0.02	.31	-108	10.6	3.38	150	-13.8	.202	16	.31	-107	0.85
0.05	.18	-114	8.8	2.75	160	-13.5	.212	8	.20	-117	1.06
0.1	.12	-141	8.1	2.53	166	-13.4	.214	3	.14	-139	1.16
0.2	.10	-166	7.9	2.47	167	-13.4	.215	1	.13	-157	1.19
0.4	.10	170	7.8	2.46	163	-13.3	.215	-1	.12	-165	1.20
0.6	.10	156	7.8	2.45	157	-13.3	.216	-3	.13	-167	1.20
0.8	.10	145	7.8	2.46	151	-13.3	.216	-4	.13	-168	1.19
1.0	.10	133	7.8	2.46	144	-13.3	.217	-6	.14	-169	1.19
1.5	.10	111	7.9	2.49	127	-13.2	.220	-10	.16	-173	1.17
2.0	.09	88	8.0	2.51	110	-13.0	.224	-13	.18	177	1.15
2.5	.07	89	8.2	2.58	96	-12.8	.230	-16	.21	167	1.11
3.0	.04	90	8.2	2.58	78	-12.8	.230	-21	.20	151	1.11
3.5	.06	145	8.2	2.57	59	-12.7	.233	-27	.19	137	1.11
4.0	.12	152	8.0	2.50	40	-12.7	.230	-33	.16	125	1.12
4.5	.19	142	7.5	2.38	22	-13.0	.223	-40	.13	116	1.16
5.0	.26	131	6.9	2.21	4	-13.5	.211	-47	.09	118	1.22
5.5	.32	120	6.2	2.04	-12	-14.1	.198	-52	.07	160	1.28
6.0	.38	109	5.3	1.84	-27	-14.8	.181	-56	.13	-173	1.38
6.5	.43	99	4.4	1.65	-42	-15.6	.167	-59	.21	-172	1.46

A model for this device is available in the DEVICE MODELS section.

Features

- Broadband, Minimum Ripple Cascadable 50 Ω Gain Block
- 7.2 ± 0.5 dB typical Gain Flatness from 0.1 to 3.0 GHz
- 3 dB Bandwidth: 0.1 to 5.5 GHz
- 10.5 dBm typical P_{1 dB} at 2.0 GHz
- Surface Mount Plastic Package
- Tape-and-Reel Packaging Option Available¹

Description

Avantek's MSA-0986 is a high performance silicon bipolar Monolithic Microwave Integrated Circuit (MMIC) housed in a low cost surface mount plastic package. This MODAMP™ MMIC is designed for very wide bandwidth industrial and commercial applications that require flat gain and low VSWR.

The MODAMP MSA-series is fabricated using a 10 GHz f_r 25 GHz f_{max} silicon bipolar MMIC process which utilizes nitride self-alignment, ion implantation and gold metallization to achieve excellent uniformity, performance and reliability. The use of an external bias resistor for temperature and current stability also allows bias flexibility.

Avantek 86 Plastic Package

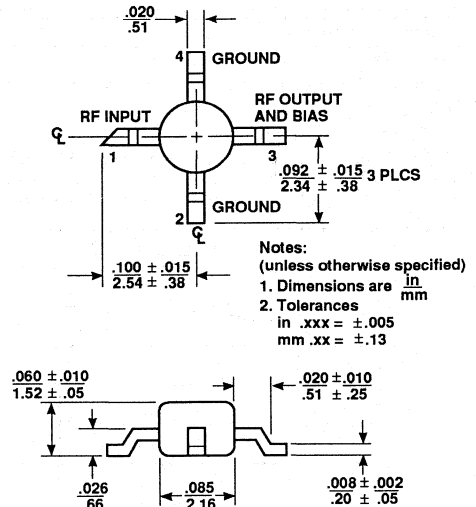

Typical Biasing Configuration

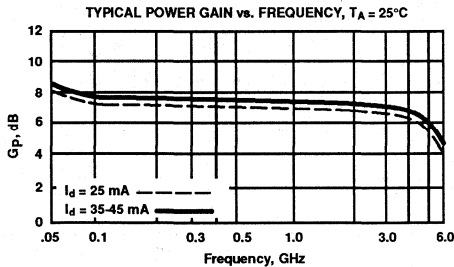
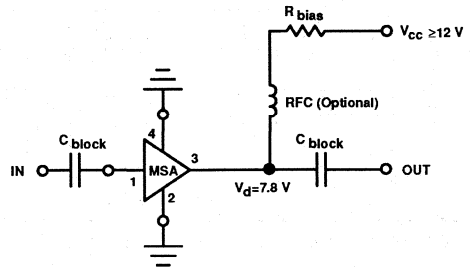

Electrical Specifications², T_A = 25°C

Symbol	Parameters and Test Conditions: I _d = 35 mA, Z ₀ = 50 Ω	Units	Min.	Typ.	Max.
G _p	Power Gain (S ₂₁ ²) f = 2.0 GHz	dB	6.0	7.2	
ΔG _p	Gain Flatness f = 0.1 to 3.0 GHz	dB		±0.5	
f _{3 dB}	3 dB Bandwidth ³	GHz		5.5	
VSWR	Input VSWR f = 0.1 to 3.0 GHz			1.6:1	
	Output VSWR f = 0.1 to 3.0 GHz			1.8:1	
P _{1 dB}	Output Power @ 1 dB Gain Compression f = 2.0 GHz	dBm		10.5	
NF	50 Ω Noise Figure f = 2.0 GHz	dB		6.2	
IP ₃	Third Order Intercept Point f = 2.0 GHz	dBm		26	
t _D	Group Delay f = 2.0 GHz	psec.		95	
V _d	Device Voltage	V	6.2	7.8	9.4
dV/dT	Device Voltage Temperature Coefficient	mV/°C		-16.0	

Notes: 1. Refer to PACKAGING section "Tape-and-Reel Packaging for Surface Mount Semiconductors".
 2. The recommended operating current range for this device is 25 mA to 45 mA. Typical performance as a function of current is on the following page.
 3. Referenced from 0.1 GHz Gain (G_p).

MSA-0986 MODAMP™ Cascadable Silicon Bipolar Monolithic Microwave Integrated Circuit Amplifiers

Absolute Maximum Ratings

Parameter	Absolute Maximum ¹
Device Current	65 mA
Power Dissipation ^{2,3}	500 mW
RF Input Power	+20 dBm
Junction Temperature	150°C
Storage Temperature	-65°C to +150°C

Thermal Resistance^{2,4}: $\theta_{jC} = 140^\circ\text{C/W}$

Notes:

1. Permanent damage may occur if any of these limits are exceeded.
2. TCASE = 25°C
3. Derate at 7.1 mW/°C for TC > 80°C.
4. See MEASUREMENTS section "Thermal Resistance" for more information.

Part Number Ordering Information

Part Number	Devices Per Reel	Reel Size
MSA-0986-TR1	1000	7"
MSA-0986-TR2	4000	13"

Typical Performance, T_A = 25°C

(unless otherwise noted)

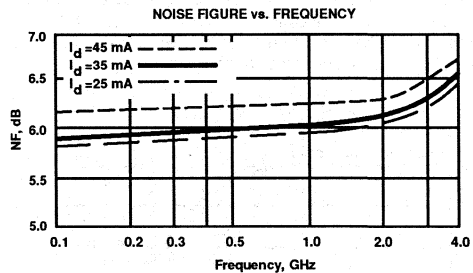
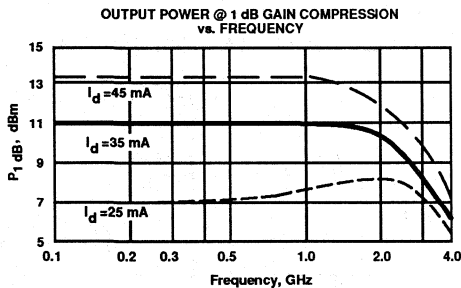
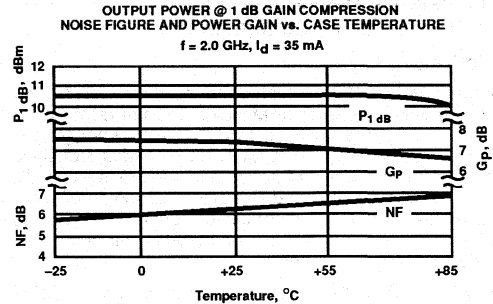
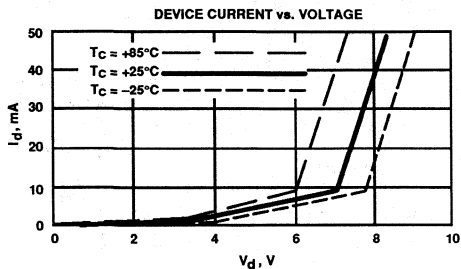

Typical Scattering Parameters: Z₀ = 50 Ω

T_A = 25°C, I_d = 35 mA

Freq. GHz	S ₁₁		S ₂₁		S ₁₂		S ₂₂		k		
	Mag	Ang	dB	Mag	Ang	dB	Mag	Ang			
0.02	.36	-105	11.4	3.72	145	-14.1	.198	18	.38	-102	0.73
0.05	.24	-145	8.5	2.65	156	-13.7	.205	5	.25	-143	1.08
0.1	.22	-164	7.7	2.43	166	-13.5	.211	4	.22	-158	1.17
0.2	.21	-179	7.5	2.37	167	-13.5	.212	1	.22	-172	1.20
0.4	.21	165	7.4	2.34	162	-13.4	.214	-1	.22	179	1.20
0.6	.22	155	7.4	2.33	156	-13.5	.212	-2	.22	175	1.21
0.8	.22	145	7.3	2.33	149	-13.4	.213	-2	.23	171	1.21
1.0	.23	136	7.3	2.32	142	-13.4	.214	-4	.24	167	1.20
1.5	.24	118	7.2	2.30	125	-13.3	.217	-6	.26	157	1.19
2.0	.25	106	7.2	2.28	109	-13.0	.224	-10	.28	148	1.16
2.5	.26	100	7.2	2.29	94	-13.0	.224	-12	.33	139	1.15
3.0	.26	94	7.1	2.26	77	-13.0	.224	-15	.34	128	1.15
3.5	.26	95	7.0	2.23	60	-12.8	.229	-21	.36	116	1.14
4.0	.28	96	6.7	2.17	43	-13.1	.221	-25	.35	104	1.18
4.5	.31	100	6.5	2.10	26	-13.6	.210	-31	.32	94	1.23
5.0	.37	101	6.0	2.00	9	-14.2	.196	-35	.26	86	1.30
5.5	.44	97	5.4	1.86	-7	-14.9	.181	-38	.19	88	1.38
6.0	.51	94	4.6	1.69	-22	-15.8	.162	-37	.14	107	1.47

A model for this device is available in the DEVICE MODELS section.

Features

- **High Output Power:**
 +27 dBm typical $P_{1\text{ dB}}$ at 1.0 GHz
- **Low Distortion:**
 37 dBm typical IP_3 at 1.0 GHz
- **8.5 dB typical Gain at 1.0 GHz**
- **Hermetic, Metal/Beryllia Stripline Package**
- **Impedance Matched to 25 Ω**
 for Push-Pull Configuration

Description

Avantek's MSA-1023 is a high performance, medium power silicon bipolar Monolithic Microwave Integrated Circuit (MMIC) housed in a hermetic, BeO flange package for good thermal characteristics. This MODAMP™ MMIC is designed for use in a push-pull configuration in a 25 Ω system. The MSA-1023 can also be used as a single-ended amplifier in a 50 Ω system with slightly reduced performance. Typical applications include narrow and broadband RF amplifiers in industrial and military systems.

The MODAMP MSA-series is fabricated using a 10 GHz f_T , 25 GHz f_{MAX} silicon bipolar MMIC process which utilizes nitride self-alignment, ion implantation and gold metallization to achieve excellent uniformity, performance, and reliability. The use of an external bias resistor for temperature and current stability also allows bias flexibility.

Avantek 230 mil BeO Flange Package

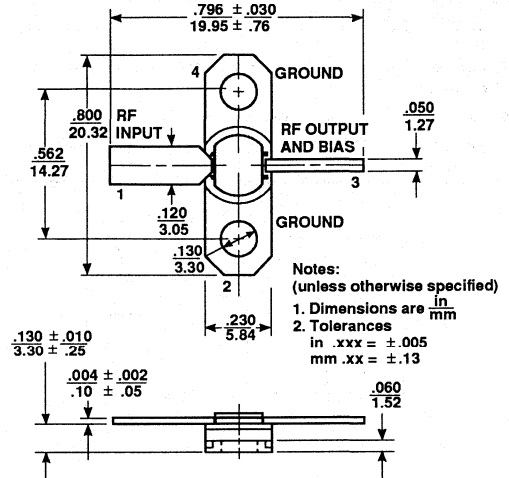

Typical Push-Pull Biasing Configuration

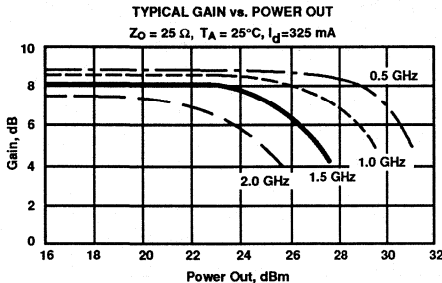
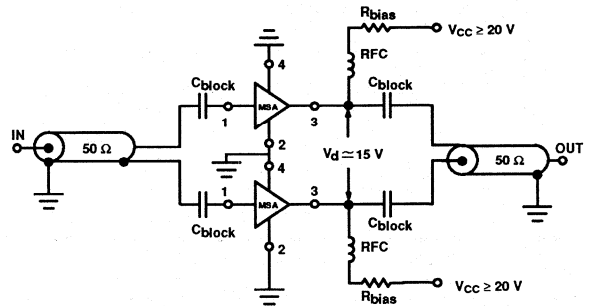

Electrical Specifications¹, $T_A = 25^\circ\text{C}$

Symbol	Parameters and Test Conditions: $I_d = 325 \text{ mA}$, $Z_0 = 25 \Omega$	Units	Min.	Typ.	Max.
$P_{1\text{ dB}}$	Output Power @ 1 dB Gain Compression $f = 1.0 \text{ GHz}$	dBm	25.0	27.0	
G_p	Power Gain ($ S_{21} ^2$) $f = 1.0 \text{ GHz}$	dB	7.5	8.5	9.5
ΔG_p	Gain Flatness $f = 0.1 \text{ to } 2.0 \text{ GHz}$	dB		±0.6	
$f_3 \text{ dB}$	3 dB Bandwidth ²	GHz		2.5	
VSWR	Input VSWR $f = 0.1 \text{ to } 2.0 \text{ GHz}$			2.0:1	
	Output VSWR $f = 0.1 \text{ to } 2.0 \text{ GHz}$			2.8:1	
IP_3	Third Order Intercept Point $f = 1.0 \text{ GHz}$	dBm		37.0	
$NF_{25 \Omega}$	25 Ω Noise Figure $f = 1.0 \text{ GHz}$	dB		7.0	
t_D	Group Delay $f = 1.0 \text{ GHz}$	psec.		250	
V_d	Device Voltage	V	13.5	15.0	16.5
dV/dT	Device Voltage Temperature Coefficient	mV/°C		-18.0	

Notes: 1. The recommended operating current range for this device is 150 mA to 400 mA. Typical performance as a function of current is on the following page.
 2. Referenced from 10 MHz Gain (G_p).

MSA-1023 MODAMP™ Cascadable Silicon Bipolar Monolithic Microwave Integrated Circuit Amplifiers

Absolute Maximum Ratings

Parameter	Absolute Maximum ¹
Device Current	425 mA
Power Dissipation ^{2,3}	7.0W
RF Input Power	+25 dBm
Junction Temperature	200°C
Storage Temperature	-65°C to 200°C

Thermal Resistance^{2,4}: $\theta_{jC} = 15^\circ\text{C/W}$

Notes:

- Permanent damage may occur if any of these limits are exceeded.
- TCASE = 25°C
- Derate at 66.7 mW/°C for $T_C > 95^\circ\text{C}$.
- The small spot size of this technique results in a higher, though more accurate determination of θ_{jC} than do alternate methods. See MEASUREMENTS section "Thermal Resistance" for more information.

Typical Performance, $T_A = 25^\circ\text{C}$

(unless otherwise noted)

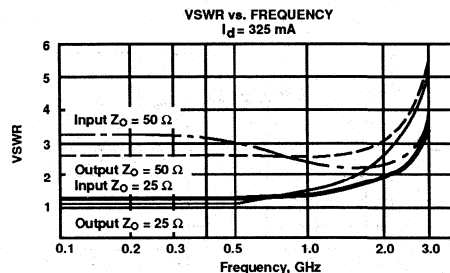
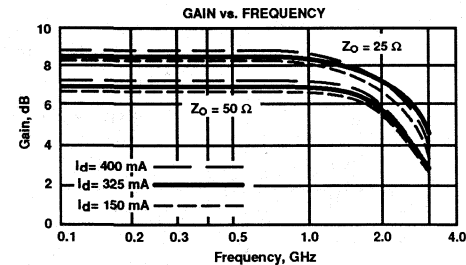
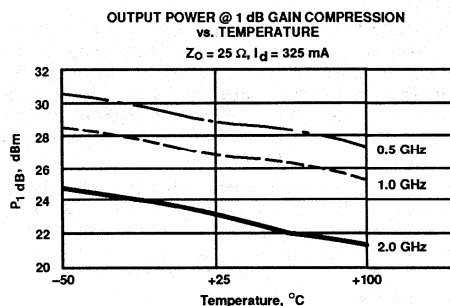
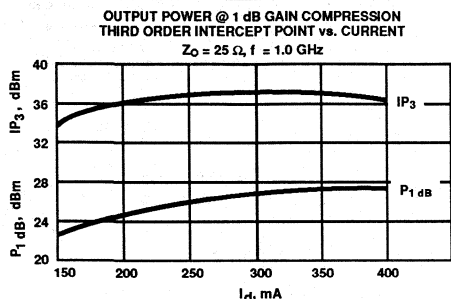
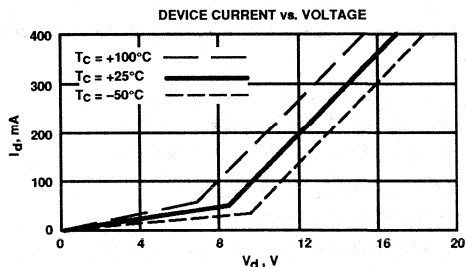

Typical Scattering Parameters: (50 Ω System)

$T_A = 25^\circ\text{C}, I_d = 325 \text{ mA}$

Freq. MHz	S ₁₁		S ₂₁		S ₁₂		S ₂₂		k		
	Mag	Ang	dB	Mag	Ang	dB	Mag	Ang			
1	.40	-121	15.3	5.85	149	-17.9	.128	22	.42	-99	0.69
5	.51	-167	8.5	2.67	156	-15.9	.160	6	.45	-161	1.05
10	.52	-174	7.5	2.36	166	-15.8	.162	3	.45	-171	1.16
25	.52	-178	7.2	2.28	172	-15.8	.162	1	.45	-177	1.20
50	.52	-179	7.1	2.26	173	-15.8	.161	-1	.45	-179	1.21
100	.53	-176	7.0	2.25	170	-15.8	.161	-3	.45	-179	1.21
200	.53	-172	7.0	2.25	163	-15.8	.161	-5	.46	-174	1.21
400	.51	-164	7.0	2.24	146	-15.8	.161	-11	.46	-170	1.22
600	.48	-157	7.0	2.24	130	-16.0	.159	-16	.45	-165	1.23
800	.45	-151	7.0	2.23	113	-16.1	.157	-21	.44	-161	1.24
1000	.42	-146	7.0	2.23	95	-16.2	.155	-26	.44	-157	1.24
1200	.38	-144	6.9	2.22	78	-16.4	.151	-31	.44	-155	1.24
1400	.35	-145	6.8	2.20	61	-16.7	.146	-36	.45	-154	1.24
1600	.34	-149	6.6	2.15	44	-17.0	.141	-41	.46	-153	1.22
1800	.36	-152	6.3	2.07	19	-17.3	.136	-45	.49	-150	1.18
2000	.39	-153	5.9	1.97	11	-17.7	.130	-49	.62	-148	1.13
2500	.51	-148	4.6	1.69	-24	-18.3	.121	-52	.52	-140	0.91
3000	.60	-133	3.0	1.41	-57	-17.9	.127	-57	.70	-128	0.59

A model for this device is available in the DEVICE MODELS section.

Features

- High Dynamic Range Cascadable
50 Ω or 75 Ω Gain Block
- 3 dB Bandwidth: 50 MHz to 1.3 GHz
- 17.5 dBm typical $P_{1\text{ dB}}$ at 0.5 GHz
- 12 dB typical 50 Ω Gain at 0.5 GHz
- 3.6 dB typical Noise Figure at 0.5 GHz
- Low Cost Plastic Package

Description

Avantek's MSA-1104 is a high performance silicon bipolar Monolithic Microwave Integrated Circuit (MMIC) housed in a low cost plastic package. This MODAMP™ MMIC is designed for high dynamic range in either 50 or 75 Ω systems by combining low noise figure with high IP_3 . Typical applications include narrow and broad band linear amplifiers in commercial and industrial applications.

The MODAMP MSA-series is fabricated using a 10 GHz f_T , 25 GHz f_{MAX} silicon bipolar MMIC process which utilizes nitride self-alignment, ion implantation and gold metallization to achieve excellent uniformity, performance, and reliability. The use of an external bias resistor for temperature and current stability also allows bias flexibility.

Avantek 04 Plastic Package

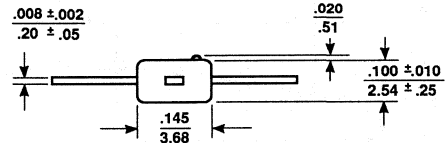
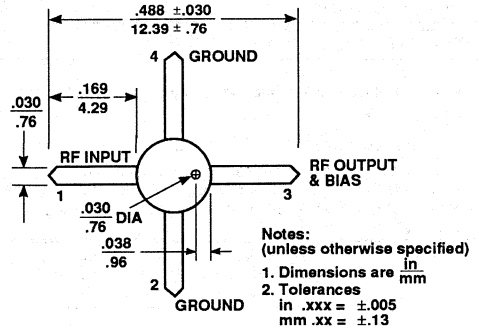

Typical Biasing Configuration

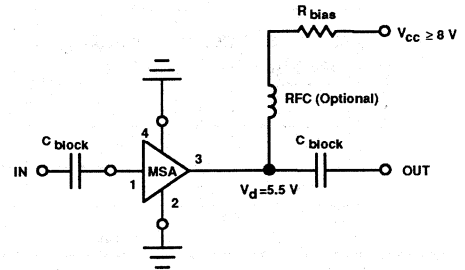

TYPICAL POWER GAIN vs. FREQUENCY
 $T_A = 25^\circ\text{C}$, $I_d = 60\text{ mA}$

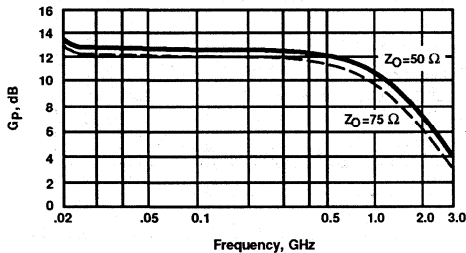

Electrical Specifications¹, $T_A = 25^\circ\text{C}$

Symbol	Parameters and Test Conditions: $I_d = 60\text{ mA}$, $Z_0 = 50\ \Omega$	Units	Min.	Typ.	Max.	
G_p	Power Gain ($ S_{21} ^2$)	$f = 0.05\text{ GHz}$	dB		12.7	
		$f = 0.5\text{ GHz}$	dB	10.0	12.0	
		$f = 1.0\text{ GHz}$	dB		10.5	
ΔG_p	Gain Flatness	dB		±1.0		
$f_{3\text{ dB}}$	3 dB Bandwidth ²	GHz		1.3		
VSWR	Input VSWR			1.5:1		
	Output VSWR			1.7:1		
$P_{1\text{ dB}}$	Output Power @ 1 dB Gain Compression	dBm		17.5		
NF	50 Ω Noise Figure	dB		3.6		
IP_3	Third Order Intercept Point	dBm		30		
t_D	Group Delay	psec.		200		
V_d	Device Voltage	V	4.4	5.5	6.6	
dV/dT	Device Voltage Temperature Coefficient	mV/°C		-8.0		

Notes: 1. The recommended operating current range for this device is 40 mA to 70 mA. Typical performance as a function of current is on the following page.
2. Referenced from 50 MHz Gain (G_p).

MSA-1104 MODAMP™ Cascadable Silicon Bipolar Monolithic Microwave Integrated Circuit Amplifiers

Absolute Maximum Ratings

Parameter	Absolute Maximum ¹
Device Current	80 mA
Power Dissipation ^{2,3}	550 mW
RF Input Power	+20 dBm
Junction Temperature	150°C
Storage Temperature	-65°C to 150°C

Thermal Resistance^{2,4}: $\theta_{jc} = 115^\circ\text{C}/\text{W}$

Notes:

1. Permanent damage may occur if any of these limits are exceeded.
2. TCASE = 25°C
3. Derate at 8.7 mW/°C for $T_C > 87^\circ\text{C}$.
4. See MEASUREMENTS section "Thermal Resistance" for more information.

Typical Performance, $T_A = 25^\circ\text{C}$, $Z_O = 50 \Omega$

(unless otherwise noted)

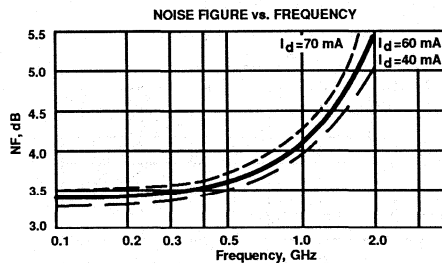
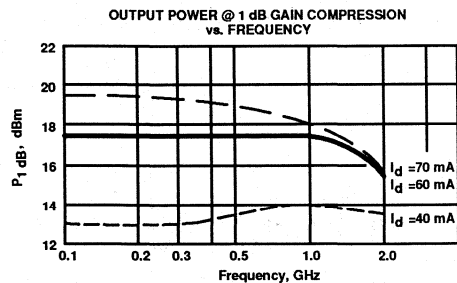
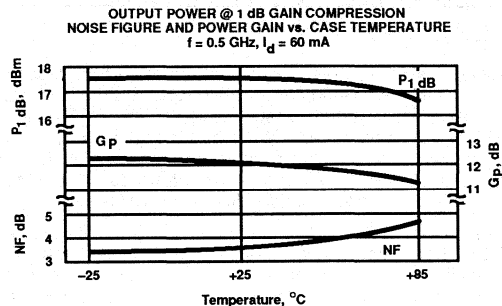
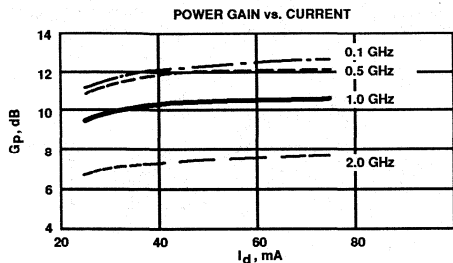
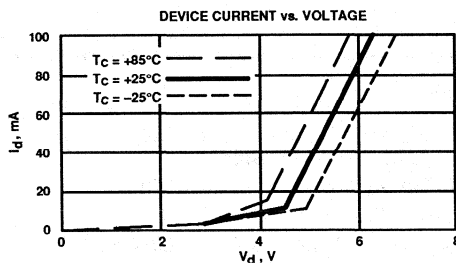

Typical Scattering Parameters: $Z_O = 50 \Omega$

$T_A = 25^\circ\text{C}$, $I_d = 60 \text{ mA}$

Freq. MHz	S11		S21		S12			S22		k	
	Mag	Ang	dB	Mag	Ang	dB	Mag	Ang	Mag		Ang
0.5	.76	-22	19.3	9.19	167	-24.4	.060	54	.77	-22	0.48
5.0	.20	-79	13.7	4.83	164	-16.5	.149	12	.21	-83	0.96
25.0	.05	-78	12.8	4.35	174	-16.2	.154	2	.06	-101	1.07
50.0	.04	-75	12.7	4.31	174	-16.4	.151	2	.05	-136	1.09
100.0	.04	-81	12.6	4.29	171	-16.4	.152	2	.05	-137	1.09
200.0	.04	-93	12.6	4.24	164	-16.3	.153	3	.07	-135	1.09
300.0	.06	-105	12.4	4.18	156	-16.2	.155	4	.10	-136	1.08
400.0	.07	-115	12.3	4.11	148	-16.0	.158	5	.12	-139	1.07
500.0	.09	-124	12.1	4.01	141	-15.8	.162	6	.15	-144	1.06
600.0	.11	-132	11.8	3.91	134	-15.6	.166	7	.17	-150	1.06
700.0	.13	-140	11.6	3.80	126	-15.4	.170	7	.19	-156	1.05
800.0	.15	-147	11.3	3.68	120	-15.2	.174	7	.22	-161	1.04
900.0	.16	-154	11.0	3.56	113	-14.9	.180	7	.24	-168	1.03
1000.0	.18	-161	10.7	3.43	106	-14.7	.184	6	.26	-173	1.03
1500.0	.28	171	9.1	2.85	77	-13.5	.211	2	.35	163	0.99
2000.0	.37	149	7.6	2.39	52	-13.0	.224	-5	.43	140	0.99
2500.0	.45	133	6.1	2.02	33	-12.7	.231	-10	.47	125	1.02
3000.0	.52	118	4.6	1.69	14	-12.6	.234	-16	.50	112	1.05

A model for this device is available in the DEVICE MODELS section.

Features

- High Dynamic Range Cascadable
50 Ω or 75 Ω Gain Block
- 3 dB Bandwidth: 50 MHz to 1.3 GHz
- 17.5 dBm typical P_{1 dB} at 0.5 GHz
- 3.6 dB typical Noise Figure at 0.5 GHz
- Surface Mount Plastic Package
- Tape-and-Reel Packaging Option Available¹

Description

Avantek's MSA-1105 is a high performance silicon bipolar Monolithic Microwave Integrated Circuit (MMIC) housed in a low cost, surface mount plastic package. This MODAMP™ MMIC is designed for high dynamic range in either 50 or 75 ohm systems by combining low noise figure with high IP₃. Typical applications include narrow and broad band linear amplifiers in commercial and industrial applications.

The MODAMP MSA-series is fabricated using a 10 GHz f_r, 25 GHz f_{max} silicon bipolar MMIC process which utilizes nitride self-alignment, ion implantation and gold metallization to achieve excellent uniformity, performance and reliability. The use of an external bias resistor for temperature and current stability also allows bias flexibility.

Avantek 05 Plastic Package

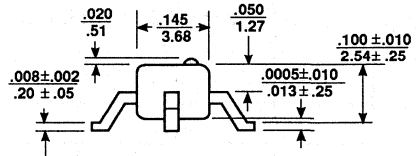
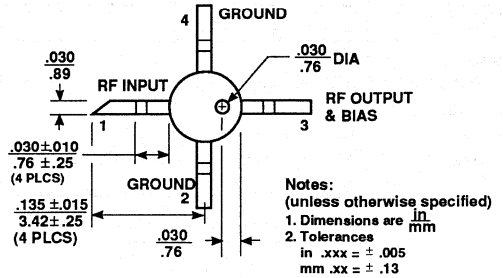

Typical Biasing Configuration

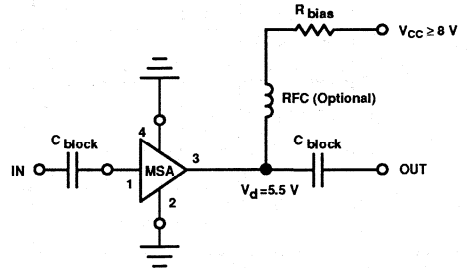

TYPICAL POWER GAIN vs. FREQUENCY

T_A = 25°C, I_d = 60 mA

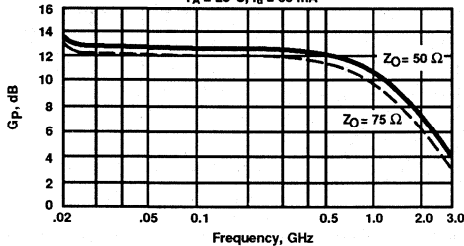

Electrical Specifications², T_A = 25°C

Symbol	Parameters and Test Conditions: I _d = 60 mA, Z ₀ = 50 Ω	Units	Min.	Typ.	Max.	
G _p	Power Gain (S ₂₁ ²)	f = 0.05 GHz	dB		12.7	
		f = 0.5 GHz	dB	10.0	12.0	
		f = 1.0 GHz	dB		10.5	
ΔG _p	Gain Flatness	f = 0.1 to 1.0 GHz	dB	±1.0		
f _{3 dB}	3 dB Bandwidth ³		GHz	1.3		
VSWR	Input VSWR	f = 0.1 to 1.0 GHz		1.5:1		
	Output VSWR	f = 0.1 to 1.0 GHz		1.7:1		
P _{1 dB}	Output Power @ 1 dB Gain Compression	f = 0.5 GHz	dBm	17.5		
NF	50 Ω Noise Figure	f = 0.5 GHz	dB	3.6		
IP ₃	Third Order Intercept Point	f = 0.5 GHz	dBm	30		
t _D	Group Delay	f = 0.5 GHz	psec.	200		
V _d	Device Voltage		V	4.4	5.5	6.6
dV/dT	Device Voltage Temperature Coefficient		mV/°C	-8.0		

Notes: 1. Refer to PACKAGING section "Tape-and-Reel Packaging for Surface Mount Semiconductors".

2. The recommended operating current range for this device is 40 mA to 70 mA. Typical performance as a function of current is on the following page.

3. Referenced from 50 MHz gain (G_p).

MSA-1105 MODAMP™ Cascadable Silicon Bipolar Monolithic Microwave Integrated Circuit Amplifiers

Absolute Maximum Ratings

Parameter	Absolute Maximum ¹
Device Current	80 mA
Power Dissipation ^{2,3}	550 mW
RF Input Power	+20 dBm
Junction Temperature	150°C
Storage Temperature	-65°C to 150°C

Thermal Resistance^{2,4}: $\theta_{jC} = 125^\circ\text{C/W}$

Notes:

1. Permanent damage may occur if any of these limits are exceeded.
2. TCASE = 25°C
3. Derate at 8 mW/°C for TC > 124°C.
4. See MEASUREMENTS section "Thermal Resistance" for more information.

Part Number Ordering Information

Part Number	Devices Per Reel	Reel Size
MSA-1105-TR1	500	7"
MSA-1105-TR2	1500	13"

Typical Performance, TA = 25°C, ZO = 50 Ω

(unless otherwise noted)

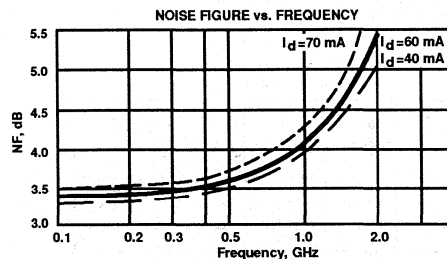
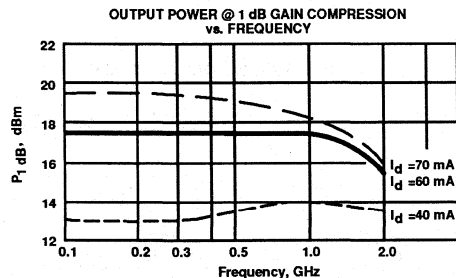
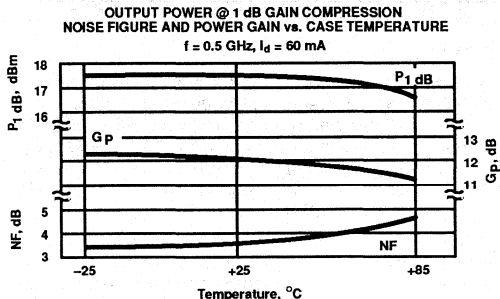
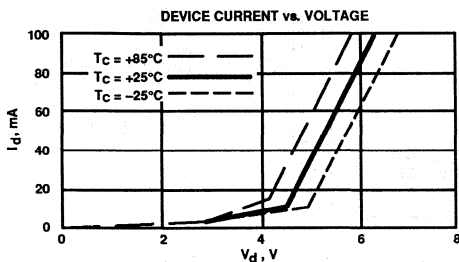

Typical Scattering Parameters: ZO = 50 Ω

TA = 25°C, Id = 60 mA

Freq. MHz	S11		S21			S12			S22		k
	Mag	Ang	dB	Mag	Ang	dB	Mag	Ang	Mag	Ang	
0.5	.80	-17	19.0	8.94	171	-26.0	.050	51	.81	-16	0.53
5.0	.26	-62	13.9	4.98	163	-16.8	.144	15	.26	-64	0.93
25.0	.07	-48	12.8	4.36	174	-16.4	.151	4	.08	-52	1.08
50.0	.06	-38	12.7	4.33	174	-16.3	.153	2	.06	-48	1.08
100.0	.05	-41	12.7	4.31	170	-16.4	.152	3	.06	-52	1.09
200.0	.06	-58	12.6	4.26	162	-16.2	.155	5	.08	-73	1.08
300.0	.07	-74	12.4	4.19	154	-16.1	.157	7	.10	-91	1.07
400.0	.09	-91	12.2	4.10	146	-15.8	.163	8	.12	-105	1.06
500.0	.10	-105	12.0	4.00	138	-15.6	.166	8	.14	-116	1.05
600.0	.11	-116	11.8	3.88	131	-15.4	.171	10	.17	-126	1.04
700.0	.13	-128	11.5	3.76	123	-15.0	.178	11	.18	-135	1.03
800.0	.15	-136	11.2	3.63	116	-14.7	.184	11	.21	-144	1.01
900.0	.16	-145	10.9	3.49	109	-15.5	.188	11	.22	-151	1.01
1000.0	.18	-152	10.5	3.37	102	-14.1	.197	11	.24	-159	1.00
1500.0	.28	174	8.8	2.75	72	-13.2	.219	7	.31	170	1.00
2000.0	.38	150	7.1	2.28	48	-12.1	.248	0	.34	151	0.99
2500.0	.46	133	5.6	1.90	28	-11.9	.254	-4	.38	134	1.02
3000.0	.53	118	4.2	1.62	11	-11.6	.262	-8	.40	122	1.04

A model for this device is available in the DEVICE MODELS section.

Features

- High Dynamic Range Cascadable
50 Ω or 75 Ω Gain Block
- 3 dB Bandwidth: 50 MHz to 1.6 GHz
- 17.5 dBm typical $P_{1\text{ dB}}$ at 0.5 GHz
- 12 dB typical 50 Ω Gain at 0.5 GHz
- 3.5 dB typical Noise Figure at 0.5 GHz
- Hermetic Gold-ceramic Microstrip Package

Description

Avantek's MSA-1110 is a high performance silicon bipolar Monolithic Microwave Integrated Circuit (MMIC) housed in a hermetic high reliability package. This MODAMP™ MMIC is designed for high dynamic range in either 50 or 75 Ω systems by combining low noise figure with high IP_3 . Typical applications include narrow and broad band linear amplifiers in industrial and military applications.

The MODAMP MSA-series is fabricated using a 10 GHz f_r , 25 GHz f_{MAX} silicon bipolar MMIC process which utilizes nitride self-alignment, ion implantation and gold metallization to achieve excellent uniformity, performance, and reliability. The use of an external bias resistor for temperature and current stability also allows bias flexibility.

Avantek 100 mil Package

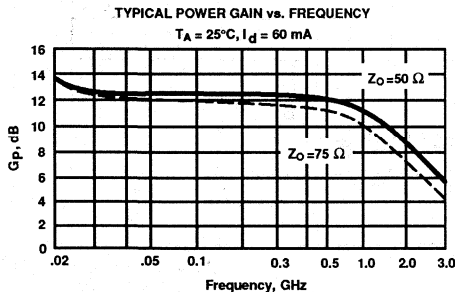
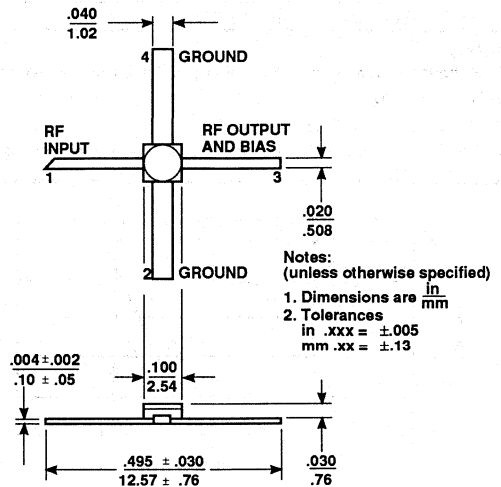

Typical Biasing Configuration

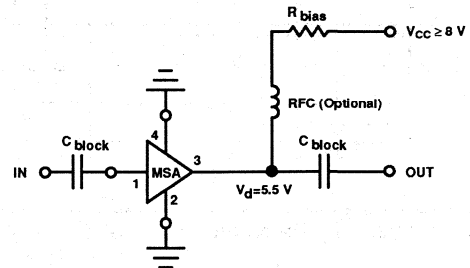

Electrical Specifications¹, $T_A = 25^\circ\text{C}$

Symbol	Parameters and Test Conditions: $I_d = 60\text{ mA}$, $Z_0 = 50\ \Omega$	Units	Min.	Typ.	Max.
G_P	Power Gain ($ S_{21} ^2$)	dB	11.5	12.5	13.5
ΔG_P	Gain Flatness	dB		±0.7	±1.0
$f_3\text{ dB}$	3 dB Bandwidth ²	GHz		1.6	
VSWR	Input VSWR			1.7:1	
	Output VSWR			1.9:1	
$P_{1\text{ dB}}$	Output Power @ 1 dB Gain Compression	dBm	16.0	17.5	
NF	50 Ω Noise Figure	dB		3.5	4.5
IP_3	Third Order Intercept Point	dBm		30.0	
t_D	Group Delay	psec.		160	
V_d	Device Voltage	V	4.5	5.5	6.5
dV/dT	Device Voltage Temperature Coefficient	mV/°C		-8.0	

Notes: 1. The recommended operating current range for this device is 40 mA to 75 mA. Typical performance as a function of current is on the following page.
2. Referenced from 50 MHz Gain (G_P).

MSA-1110 MODAMP™ Cascadable Silicon Bipolar Monolithic Microwave Integrated Circuit Amplifiers

Absolute Maximum Ratings

Parameter	Absolute Maximum ¹
Device Current	90 mA
Power Dissipation ^{2,3}	560 mW
RF Input Power	+20 dBm
Junction Temperature	200°C
Storage Temperature	-65°C to 200°C

Thermal Resistance^{2,4}: $\theta_{jc} = 135^\circ\text{C/W}$

Notes:

- Permanent damage may occur if any of these limits are exceeded.
- $T_{CASE} = 25^\circ\text{C}$
- Derate at 7.4 mW/°C for $T_C > 124^\circ\text{C}$.
- The small spot size of this technique results in a higher, though more accurate determination of θ_{jc} than do alternate methods. See MEASUREMENTS section "Thermal Resistance" for more information.

Typical Performance, $T_A = 25^\circ\text{C}$, $Z_0 = 50 \Omega$ (unless otherwise noted)

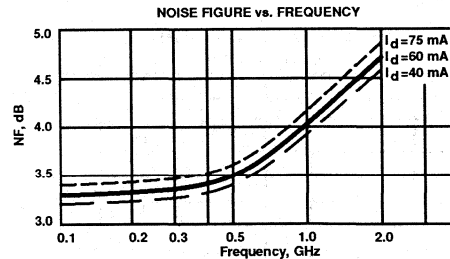
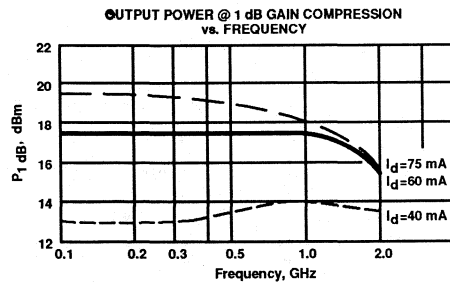
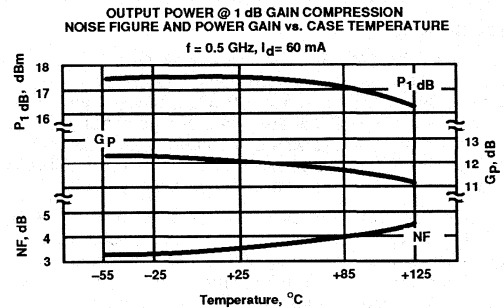
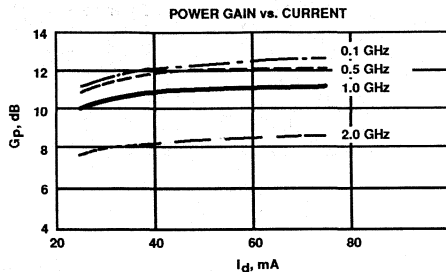
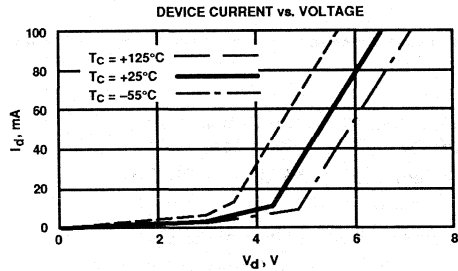

Typical Scattering Parameters: $Z_0 = 50 \Omega$

$T_A = 25^\circ\text{C}, I_d = 60 \text{ mA}$

Freq. MHz	S ₁₁		S ₂₁			S ₁₂			S ₂₂			k
	Mag	Ang	dB	Mag	Ang	dB	Mag	Ang	Mag	Ang		
0.5	.83	-7	19.5	9.44	176	-31.9	.025	39	.84	-7	0.77	
5.0	.54	-50	16.8	6.92	158	-18.7	.116	34	.55	-50	0.60	
25.0	.15	-78	13.0	4.47	167	-16.6	.148	9	.15	-79	1.03	
50.0	.10	-64	12.6	4.26	171	-16.5	.149	5	.10	-67	1.08	
100.0	.08	-63	12.5	4.23	171	-16.5	.150	4	.08	-66	1.09	
200.0	.09	-74	12.4	4.17	166	-16.4	.152	4	.09	-78	1.09	
300.0	.11	-85	12.3	4.10	160	-16.2	.154	5	.12	-89	1.07	
400.0	.13	-94	12.3	4.10	154	-16.1	.157	6	.15	-98	1.05	
500.0	.16	-102	12.1	4.04	148	-15.9	.161	7	.18	-106	1.02	
600.0	.18	-108	12.0	3.98	143	-15.6	.165	8	.20	-113	1.00	
700.0	.21	-114	11.8	3.89	137	-15.4	.169	8	.23	-120	0.97	
800.0	.23	-120	11.6	3.80	131	-15.2	.173	8	.25	-126	0.95	
900.0	.25	-126	11.4	3.71	126	-15.0	.178	8	.28	-132	0.92	
1000.0	.27	-131	11.1	3.60	120	-14.8	.182	8	.30	-137	0.91	
1500.0	.36	-153	9.8	3.10	96	-13.8	.203	4	.37	-160	0.83	
2000.0	.42	-171	8.4	2.64	74	-13.3	.217	1	.40	-178	0.82	
2500.0	.47	177	7.2	2.29	59	-12.5	.236	-2	.41	172	0.80	
3000.0	.47	159	5.9	1.97	43	-13.2	.220	-10	.38	157	0.95	

A model for this device is available in the DEVICE MODELS section.

Features

- High Dynamic Range Cascadable
50 Ω or 75 Ω Gain Block
- 3 dB Bandwidth: 50 MHz to 1.6 GHz
- 17.5 dBm typical P_{1dB} at 0.5 GHz
- 12 dB typical 50 Ω Gain at 0.5 GHz
- 3.5 dB typical Noise Figure at 0.5 GHz
- Hermetic Metal/Beryllia Microstrip Package

Description

Avantek's MSA-1120 is a high performance silicon bipolar Monolithic Microwave Integrated Circuit (MMIC) housed in a hermetic BeO disk package for good thermal characteristics. This MODAMP™ MMIC is designed for high dynamic range in either 50 or 75 Ω systems by combining low noise figure with high IP₃. Typical applications include narrow and broad band linear amplifiers in industrial and military applications.

The MODAMP MSA-series is fabricated using a 10 GHz f_T, 25 GHz f_{MAX} silicon bipolar MMIC process which utilizes nitride self-alignment, ion implantation and gold metallization to achieve excellent uniformity, performance, and reliability. The use of an external bias resistor for temperature and current stability also allows bias flexibility.

Avantek 200 mil BeO Package

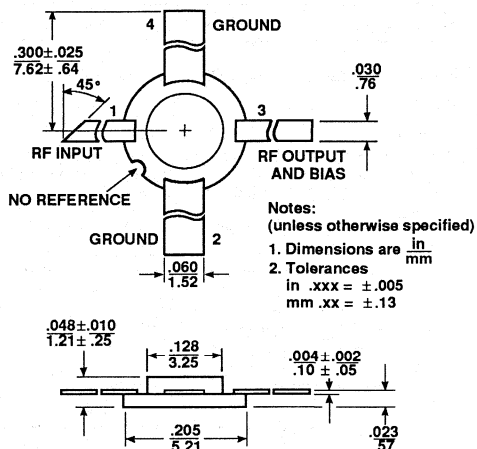

Typical Biasing Configuration

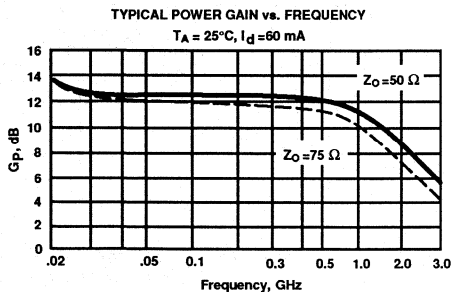
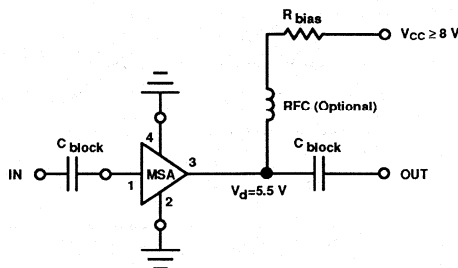

Electrical Specifications¹, T_A = 25°C

Symbol	Parameters and Test Conditions: I _d = 60 mA, Z ₀ = 50 Ω	Units	Min.	Typ.	Max.
G _p	Power Gain (S ₂₁ ²)	f = 0.1 GHz	11.5	12.5	13.5
ΔG _p	Gain Flatness	f = 0.1 to 1.0 GHz		±0.7	±1.0
f _{3dB}	3 dB Bandwidth ²			1.6	
VSWR	Input VSWR	f = 0.1 to 1.5 GHz		1.7:1	
	Output VSWR	f = 0.1 to 1.5 GHz		1.9:1	
P _{1dB}	Output Power @ 1 dB Gain Compression	f = 0.5 GHz	16.0	17.5	
NF	50 Ω Noise Figure	f = 0.5 GHz		3.5	4.5
IP ₃	Third Order Intercept Point	f = 0.5 GHz		30.0	
t _D	Group Delay	f = 0.5 GHz		200	
V _d	Device Voltage		4.5	5.5	6.5
dV/dT	Device Voltage Temperature Coefficient			-8.0	

Notes: 1. The recommended operating current range for this device is 40 mA to 75 mA. Typical performance as a function of current is on the following page.
2. Referenced from 50 MHz gain (G_p).

MSA-1120 MODAMP™ Cascadable Silicon Bipolar Monolithic Microwave Integrated Circuit Amplifiers

Absolute Maximum Ratings

Parameter	Absolute Maximum ¹
Device Current	100 mA
Power Dissipation ^{2,3}	650 mW
RF Input Power	+20 dBm
Junction Temperature	200°C
Storage Temperature	-65°C to 200°C

Thermal Resistance^{2,4}: $\theta_{jC} = 60^\circ\text{C}/\text{W}$

Notes:

- Permanent damage may occur if any of these limits are exceeded.
- $T_{\text{CASE}} = 25^\circ\text{C}$
- Derate at 16.7 mW/°C for $T_C > 161^\circ\text{C}$.
- The small spot size of this technique results in a higher, though more accurate determination of θ_{jC} than do alternate methods. See MEASUREMENTS section "Thermal Resistance" for more information.

Typical Performance, $T_A = 25^\circ\text{C}$, $Z_O = 50 \Omega$

(unless otherwise noted)

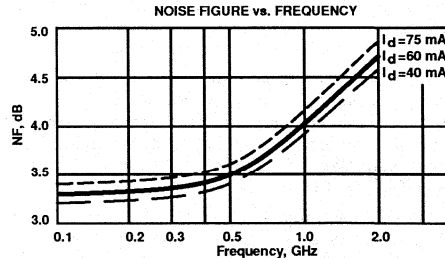
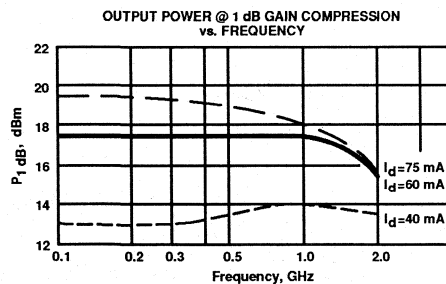
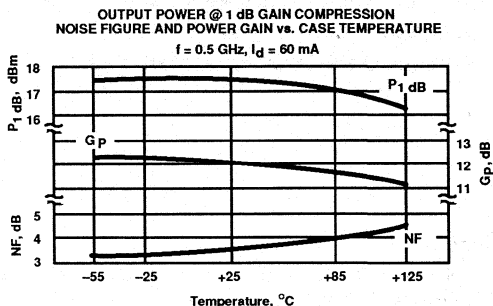
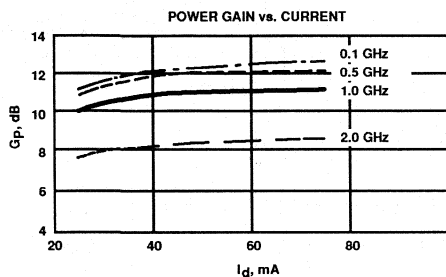
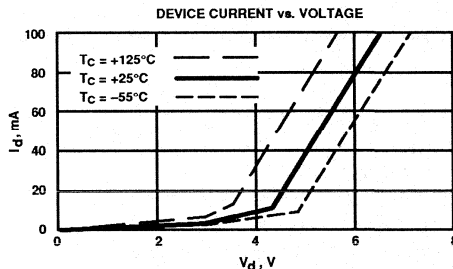

Typical Scattering Parameters: $Z_O = 50 \Omega$

$T_A = 25^\circ\text{C}, I_d = 60 \text{ mA}$

Freq. MHz	S ₁₁		S ₂₁			S ₁₂			S ₂₂		k
	Mag	Ang	dB	Mag	Ang	dB	Mag	Ang	Mag	Ang	
0.5	.78	-21	19.6	9.53	168	-25.1	.057	50	.79	-21	0.51
5.0	.19	-72	13.8	4.91	165	-16.8	.144	11	.19	-72	0.98
25.0	.05	-56	12.9	4.44	174	-16.5	.149	3	.06	-75	1.08
50.0	.04	-52	12.5	4.23	174	-16.1	.156	2	.04	-79	1.08
100.0	.04	-56	12.5	4.22	172	-16.2	.155	1	.04	-78	1.09
200.0	.05	-72	12.4	4.19	165	-16.1	.157	1	.06	-91	1.08
300.0	.07	-84	12.4	4.15	158	-16.0	.159	2	.09	-101	1.07
400.0	.09	-96	12.3	4.10	151	-15.9	.161	2	.11	-109	1.06
500.0	.10	-105	12.1	4.04	144	-15.8	.163	3	.13	-117	1.05
600.0	.12	-113	12.0	3.98	137	-15.6	.166	3	.16	-124	1.04
700.0	.14	-120	11.8	3.89	131	-15.4	.169	2	.18	-130	1.03
800.0	.15	-127	11.6	3.80	124	-15.2	.173	2	.20	-136	1.01
900.0	.17	-134	11.4	3.71	118	-15.0	.178	1	.22	-142	1.00
1000.0	.19	-140	11.1	3.60	112	-14.8	.181	2	.24	-148	0.99
1500.0	.25	-167	9.8	3.10	83	-14.0	.200	-3	.31	-174	0.95
2000.0	.31	171	8.4	2.64	58	-13.3	.216	-10	.35	163	0.95
2500.0	.35	157	7.3	2.31	39	-12.8	.228	-16	.36	148	0.96
3000.0	.40	140	6.1	2.02	19	-12.5	.236	-23	.36	134	0.99

A model for this device is available in the DEVICE MODELS section.

Features

- Open Loop Feedback Amplifier
- Performance Flexibility with User Selected External Feedback for:
 - Broadband Minimum Ripple Amplifiers
 - Low Return Loss Amplifiers
 - Negative Gain Slope Amplifiers
- Usable Gain to 6.0 GHz
- 16.0 dB Typical Open Loop Gain at 1.0 GHz
- 14.5 dBm Typical $P_{1\text{ dB}}$ at 1.0 GHz
- Hermetic Gold-Ceramic Microstrip Package

Description

Avantek's MSA-9970 is a high performance silicon bipolar Monolithic Microwave Integrated Circuit (MMIC) housed in a hermetic high reliability package. This MODAMP™ MMIC is designed with high open loop gain and is intended to be used with external resistive and reactive feedback elements to create a variety of special purpose gain blocks.

Applications include very broadband, minimum ripple amplifiers with extended low frequency performance possible through the use of a high valued external feedback blocking capacitor; extremely well matched (-20 dB return loss) amplifiers; and negative gain slope amplifiers for flattening MODAMP MMIC cascades.

The MODAMP MSA-series is fabricated using a 10 GHz f_T , 25 GHz f_{MAX} silicon bipolar MMIC process which utilizes nitride self-alignment, ion implantation and gold metallization to achieve excellent uniformity, performance, and reliability. The use of an external bias resistor for temperature and current stability also allows bias flexibility.

Avantek 70 mil Package

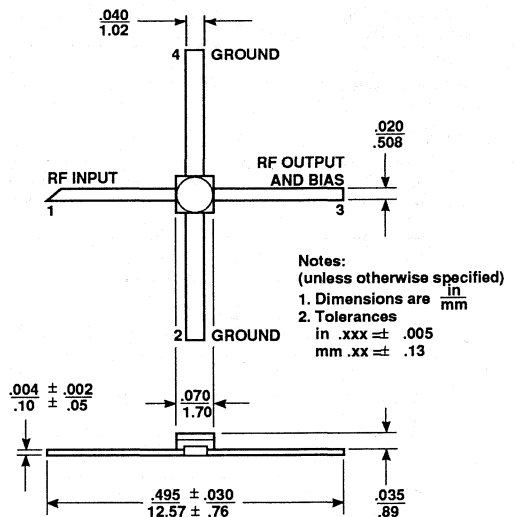

Typical Biasing Configuration

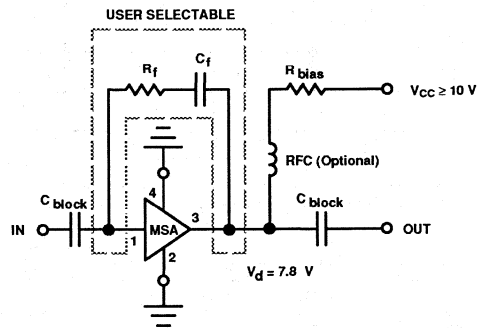

Electrical Specifications¹, $T_A = 25^\circ\text{C}$

Symbol	Parameters and Test Conditions: $I_d = 35\text{ mA}$, $Z_O = 50\ \Omega$	Units	Min.	Typ.	Max.
G_p	Power Gain ² ($ S_{21} ^2$) $f = 0.1\text{ GHz}$ $f = 1.0\text{ GHz}$ $f = 4.0\text{ GHz}$	dB		17.5 16.0 9.0	
$P_{1\text{ dB}}$	Output Power @ 1 dB Gain Compression ² $f = 1.0\text{ GHz}$	dBm	14.5 8.0	16.0 9.0	17.5 10.0
IP_3	Third Order Intercept Point ² $f = 1.0\text{ GHz}$	dBm		25.0	
V_d	Device Voltage	V	7.0	7.8	8.6
dV/dT	Device Voltage Temperature Coefficient	mV/ $^\circ\text{C}$		-16.0	

Notes: 1. The recommended operating current range for this device is 25 mA to 45 mA. Typical performance as a function of current is on the following page.
2. Open loop value. Adding external feedback will alter device performance.

M5A-9970 MODAMP™ Cascadable Silicon Bipolar Monolithic Microwave Integrated Circuit Amplifiers

Absolute Maximum Ratings

Parameter	Absolute Maximum ¹
Device Current	80 mA
Power Dissipation ^{2,3}	750 mW
RF Input Power	+25 dBm
Junction Temperature	200°C
Storage Temperature	-65°C to 200°C

Thermal Resistance^{2,4}: $\theta_{jC} = 150^\circ\text{C/W}$

Notes:

- Permanent damage may occur if any of these limits are exceeded.
- TCASE = 25°C
- Derate at 6.7 mW/°C for $T_C > 88^\circ\text{C}$.
- The small spot size of this technique results in a higher, though more accurate determination of θ_{jC} than do alternate methods. See MEASUREMENTS section "Thermal Resistance" for more information.

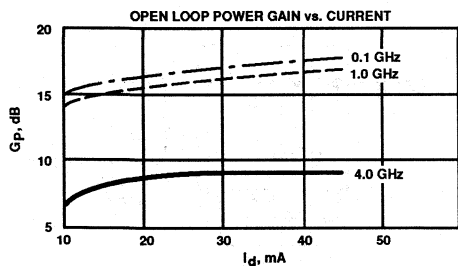
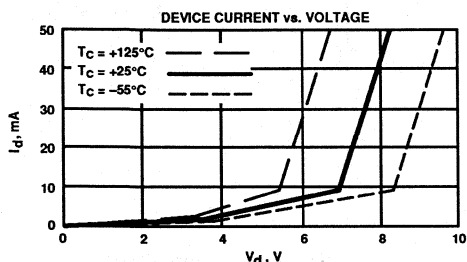

Typical Performance, $T_A = 25^\circ\text{C}$

(unless otherwise noted)

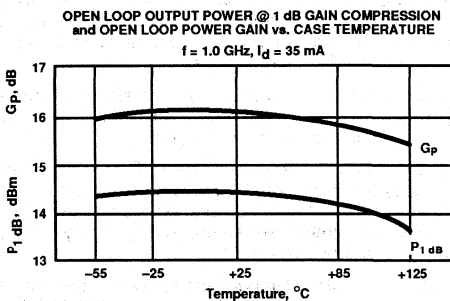
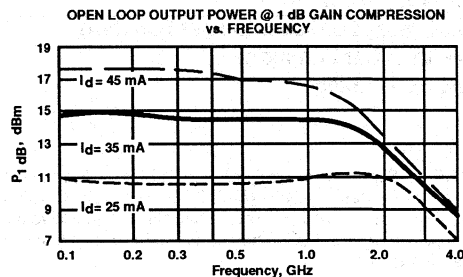
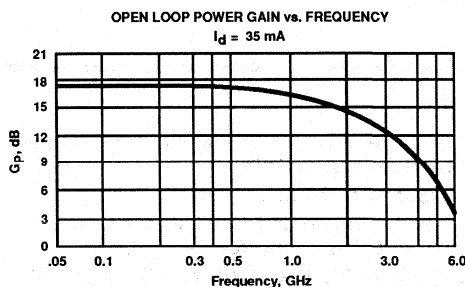

Typical Scattering Parameters: $Z_0 = 50 \Omega$

$T_A = 25^\circ\text{C}$, $I_d = 35 \text{ mA}$

Freq. GHz	S_{11}		S_{21}			S_{12}			S_{22}		k
	Mag	Ang	dB	Mag	Ang	dB	Mag	Ang	Mag	Ang	
0.02	.89	-1	17.5	7.51	179	-37.2	.014	4	.93	-1	1.01
0.05	.90	-3	17.5	7.47	177	-35.6	.017	34	.92	-3	.83
0.1	.90	-6	17.4	7.45	174	-33.2	.022	43	.93	-6	.70
0.2	.89	-12	17.4	7.43	168	-29.6	.033	61	.93	-13	.39
0.4	.87	-24	17.2	7.27	156	-24.4	.061	63	.91	-27	.24
0.6	.85	-36	17.0	7.06	145	-20.8	.091	58	.90	-40	.21
0.8	.82	-47	16.6	6.78	134	-18.8	.115	52	.87	-53	.21
1.0	.79	-59	16.2	6.49	124	-17.0	.141	44	.84	-66	.24
1.5	.72	-86	15.3	5.79	100	-14.6	.186	29	.74	-96	.28
2.0	.65	-113	14.2	5.10	77	-13.4	.215	16	.64	-123	.34
2.5	.59	-133	13.0	4.45	61	-12.9	.227	7	.57	-143	.39
3.0	.54	-155	11.6	3.79	42	-12.5	.236	-3	.51	-163	.46
3.5	.53	-174	10.3	3.28	26	-12.4	.239	-14	.45	-178	.53
4.0	.52	168	9.2	2.87	10	-12.5	.238	-22	.39	164	.59
4.5	.53	152	8.0	2.51	-4	-12.6	.234	-30	.34	155	.66
5.0	.55	140	6.9	2.21	-17	-12.8	.228	-37	.31	153	.72
5.5	.55	130	5.8	1.94	-31	-13.2	.220	-44	.30	154	.80
6.0	.55	121	4.6	1.70	-43	-13.6	.209	-48	.32	157	.88
6.5	.56	114	3.5	1.50	-53	-13.8	.203	-54	.37	158	.94
7.0	.56	107	2.6	1.34	-63	-14.0	.201	-59	.42	157	.97

A model for this device is available in the DEVICE MODELS section.

Features

- Up or Down Frequency Conversion with up to 12 dB Conversion Gain
- RF Input from 0.1 to 2.0 GHz
- Low Phase Noise Self-Oscillating LO from 0.1 to 2.0 GHz Using External Tank Circuit
- Downconverted IF Output from DC to 0.5 GHz
- Uniform Performance
- Low Power Consumption per Function
- Low Cost per Function
- Low Bias Voltage

Description

The MSF-86 Series is a family of silicon bipolar Monolithic Microwave Integrated Circuit (MMIC) Frequency Converters. These MMIC's are characterized as simple, 2-port active mixers with low power injected LO. They can also function as self-oscillating active mixers.

The MSF-86 Series is ideally suited for very low cost or size constrained designs where adequate conversion gain flatness, LO-RF and LO-IF isolation or spurious signal rejection can be achieved using simple external filters.

Typical applications include GPS navigation and INMARSAT receivers, mobile and cellular radio receivers, VHF/UHF converters, and communications and radar systems.

The MSF-86 Series is fabricated using a 10 GHz f_T silicon bipolar MMIC process that features sub-micrometer nitride self-alignment and ion-implantation to achieve excellent unit-to-unit uniformity. Biasing requires a fixed single polarity supply with an external current stabilizing resistor.

These MMIC's are offered in package styles suitable for industrial, military and commercial applications; model MSF-8635 is housed in a cost effective, glass sealed ceramic package, model MSF-8670 is in a high reliability, hermetically sealed gold-ceramic package, and model MSF-8685 is in a low cost, plastic package.

Functional Block Diagrams

2-Port Active Mixer

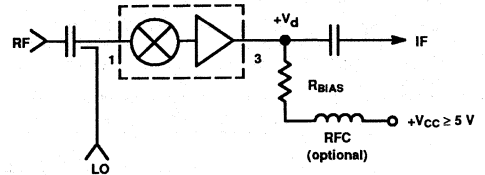

Self-Oscillating Mixer

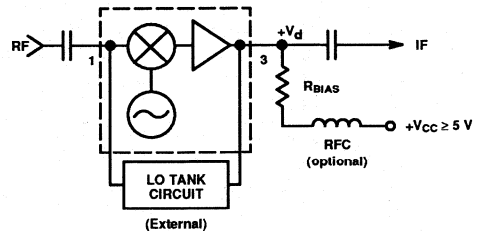

Electrical Specifications, $T_A = 25^\circ\text{C}$, $I_d = 16 \text{ mA}$, $Z_0 = 50 \Omega$
-20 dBm RF Input at 1.575 GHz and -8 dBm injected² LO at 1.4 GHz

Symbol	Parameters/Test Conditions	Units	MSF-8635			MSF-8670			MSF-8685		
			Min.	Typ.	Max.	Min.	Typ.	Max.	Min.	Typ.	Max.
G _C	Conversion Gain at 0.175 GHz IF $f = 1.575 \text{ GHz}$	dB	7.5	9.0		7.5	9.0		6.0	8.0	
P ₁ dB	Output Power at 1 dB Compression $f = 0.175 \text{ GHz}$	dBm		-2.5			-2.5			-2.5	
IP ₃	3rd Order Output Intercept Point $f = 0.175 \text{ GHz}$	dBm		7.0			7.0			7.0	
NF	Single-Side-Band Noise Figure $f = 1.575 \text{ GHz}$	dB		15.0			15.0			16.0	
VSWR	Input VSWR $f = 0.1 \text{ to } 1.5 \text{ GHz}$	-		1.4:1			1.9:1			1.5:1	
	Output VSWR $f = 0.1 \text{ to } 1.5 \text{ GHz}$	-		1.3:1			1.8:1			1.4:1	
V _d	Device Voltage	V	3.2	3.5	3.8	3.2	3.5	3.8	3.2	3.5	3.8
dV/dT	Device Voltage Temp. Coefficient	mV/°C		-8.0			-8.0			-8.0	

Notes: 1. The recommended operating range for this device is 12 mA to 25 mA. Typical performance as a function of current is on the following page.
 2. For the 2-port active mixer application, the LO power is specified at port 1 of the MMIC.

MSF-86 Series Silicon Bipolar MMIC Frequency Converter

Typical Performance, $T_A = 25^\circ\text{C}$
(unless otherwise noted)

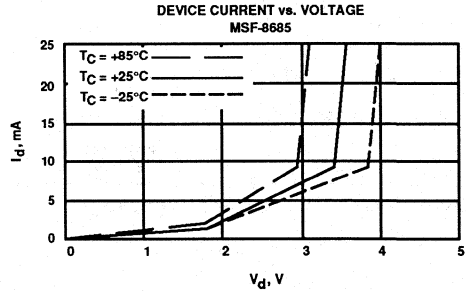
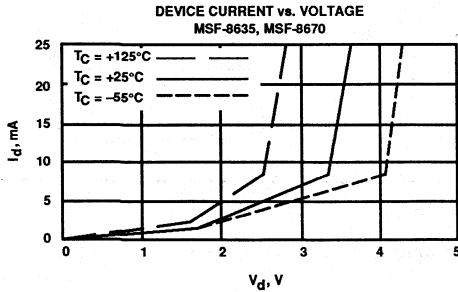
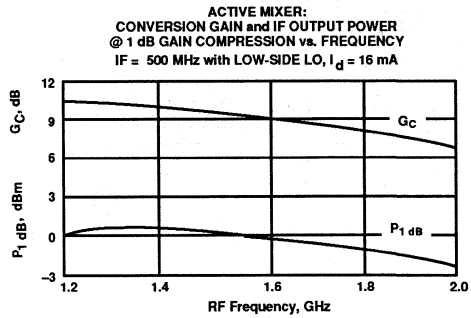
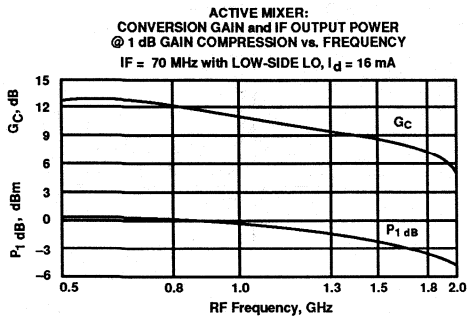
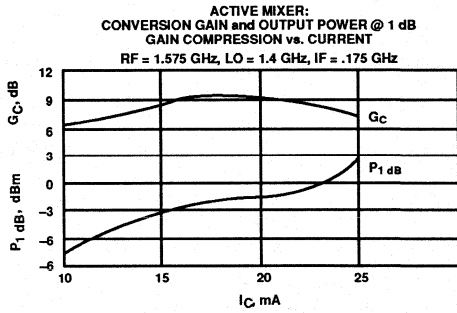
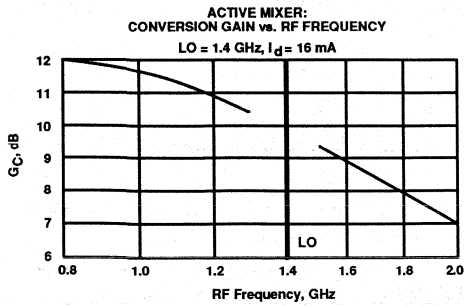

**EXAMPLE OF GPS DOWN CONVERTER USING MSF-86XX SERIES—CONVERSION GAIN = 8.5 dB AT 1.575 GHz
WITH INJECTION-LOCKED SELF-OSCILLATING LO AT 1.4 GHz**

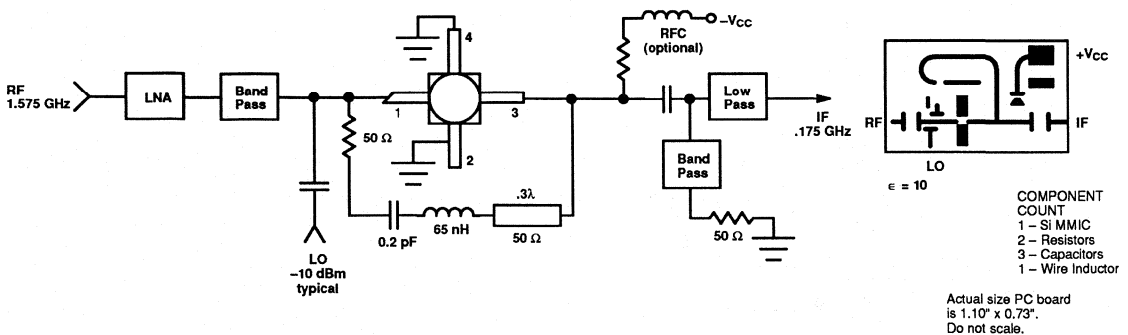

**MSF-86 Series Silicon Bipolar
MMIC Frequency Converter**

Absolute Maximum Ratings

Parameter	Absolute Maximum ¹		
	MSF-8635	MSF-8670	MSF-8685
Device Current	50 mA	50 mA	50 mA
Power Dissipation ^{2,4}	200 mW	200 mW	200 mW
RF Input Power	+20 dBm	+20 dBm	+20 dBm
Junction Temperature	200 °C	200 °C	150 °C
Storage Temperature	200 °C ³	200 °C	150 °C
Thermal Resistance ⁴	155 °C/W	130 °C/W	110 °C/W

Notes:

1. Permanent damage may occur if any of these limits are exceeded.
2. Derate at 6.5 mW/°C for $T_C > 169^\circ\text{C}$ (MSF-8635); 7.7 mW/°C for $T_C > 174^\circ\text{C}$ (MSF-8670); 9.1 mW/°C for $T_C > 128^\circ\text{C}$ (MSF-8685).
3. Storage above +150°C may tarnish the leads of this package making it difficult to solder into a circuit.
4. $T_{CASE} = 25^\circ\text{C}$.

MSF-8635 Avantek micro-X package

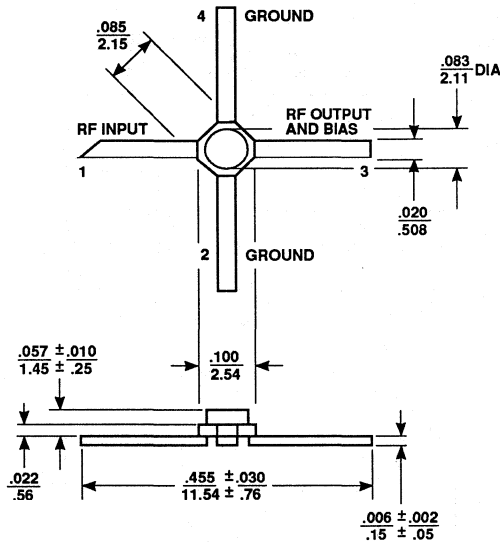

MSF-8670 Avantek 70 mil package

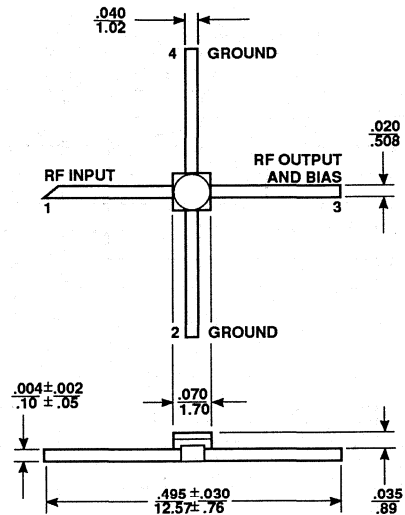

MSF-8685 Avantek 85 mil plastic package

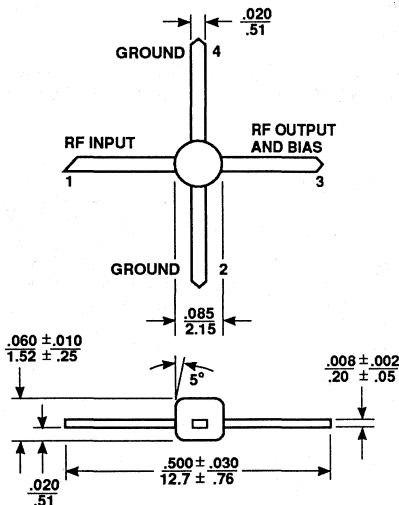

Notes:

1. Dimensions are in $\frac{\text{in}}{\text{mm}}$
2. Tolerances (unless otherwise specified)
in: .xxx = $\pm .005$
mm: .xx = $\pm .13$

**MSF-86 Series Silicon Bipolar
MMIC Frequency Converter**

Typical Scattering Parameters: MSF-8635

$T_A = 25^\circ\text{C}, I_d = 16 \text{ mA}$

Freq. GHz	S ₁₁		S ₂₁			S ₁₂			S ₂₂		k
	Mag	Ang	dB	Mag	Ang	dB	Mag	Ang	Mag	Ang	
0.1	.03	-178	20.5	10.59	171	-23.4	.068	5	.04	-44	1.05
0.2	.02	-177	20.3	10.31	161	-22.9	.071	8	.05	-68	1.04
0.3	.02	-164	20.0	9.96	152	-22.4	.076	14	.06	-87	1.04
0.4	.02	-116	19.6	9.55	144	-22.0	.079	19	.07	-104	1.03
0.5	.02	-100	19.2	9.08	136	-21.8	.081	21	.09	-114	1.04
0.6	.04	-89	18.7	8.59	128	-21.3	.086	24	.09	-123	1.04
0.8	.07	-96	17.7	7.66	115	-20.2	.098	29	.10	-140	1.03
1.0	.10	-108	16.6	6.79	103	-19.4	.107	31	.11	-156	1.02
1.5	.17	-134	14.2	5.13	79	-17.2	.138	30	.12	172	1.03
2.0	.24	-160	12.1	4.01	60	-15.8	.163	26	.12	148	1.04
2.5	.31	-178	10.3	3.26	48	-15.1	.175	27	.12	140	1.08
3.0	.37	166	8.7	2.72	34	-14.4	.190	24	.11	135	1.10
3.5	.42	151	7.4	2.33	21	-13.9	.203	19	.10	144	1.11
4.0	.46	139	6.2	2.04	9	-13.3	.216	16	.08	167	1.11
4.5	.48	126	5.1	1.81	-3	-12.8	.229	12	.08	-173	1.11
5.0	.52	110	4.2	1.62	-15	-12.2	.245	8	.09	-173	1.09

Typical Scattering Parameters: MSF-8670

$T_A = 25^\circ\text{C}, I_d = 16 \text{ mA}$

Freq. GHz	S ₁₁		S ₂₁			S ₁₂			S ₂₂		k
	Mag	Ang	dB	Mag	Ang	dB	Mag	Ang	Mag	Ang	
0.1	.05	-147	20.5	10.62	172	-23.3	.068	4	.05	-69	1.05
0.2	.07	-134	20.4	10.41	164	-23.0	.070	8	.09	-92	1.04
0.3	.09	-126	20.1	10.16	156	-22.6	.074	12	.13	-104	1.02
0.4	.11	-123	19.9	9.85	148	-22.4	.076	14	.16	-113	1.00
0.5	.13	-123	19.6	9.50	141	-22.0	.079	16	.20	-121	0.99
0.6	.15	-123	19.2	9.09	135	-21.8	.082	18	.22	-128	0.97
0.8	.19	-126	18.4	8.28	122	-20.7	.093	22	.25	-141	0.94
1.0	.24	-129	17.5	7.46	110	-19.8	.103	22	.27	-154	0.92
1.5	.31	-141	15.2	5.76	87	-18.2	.124	23	.27	-176	0.91
2.0	.38	-157	13.0	4.47	68	-17.2	.138	19	.24	166	0.94
2.5	.42	-167	11.1	3.59	57	-16.7	.146	20	.21	158	1.01
3.0	.46	178	9.5	2.97	45	-16.4	.152	16	.17	156	1.07
3.5	.48	173	7.9	2.49	33	-16.2	.155	11	.14	163	1.15
4.0	.48	164	6.6	2.13	22	-16.1	.156	9	.11	-175	1.27
4.5	.48	155	5.5	1.87	13	-15.9	.161	5	.11	-154	1.35
5.0	.48	143	4.5	1.67	3	-15.8	.163	3	.14	-141	1.46

Typical Scattering Parameters: MSF-8685

$T_A = 25^\circ\text{C}, I_d = 16 \text{ mA}$

Freq. GHz	S ₁₁		S ₂₁			S ₁₂			S ₂₂		k
	Mag	Ang	dB	Mag	Ang	dB	Mag	Ang	Mag	Ang	
0.1	.04	171	20.1	10.09	171	-22.5	.075	5	.04	-30	1.04
0.2	.02	-180	19.8	9.75	161	-22.4	.076	10	.05	-56	1.04
0.3	.02	-143	19.4	9.38	153	-22.2	.077	15	.07	-76	1.05
0.4	.03	-113	19.1	8.99	145	-21.8	.081	17	.08	-91	1.04
0.5	.05	-105	18.7	8.57	138	-21.3	.086	21	.10	-104	1.04
0.6	.07	-101	18.2	8.14	131	-20.7	.092	25	.11	-116	1.03
0.8	.10	-111	17.3	7.32	119	-19.7	.103	28	.13	-134	1.01
1.0	.13	-118	16.4	6.57	107	-18.8	.115	28	.14	-150	0.99
1.5	.21	-140	14.1	5.06	84	-17.1	.140	28	.15	180	1.00
2.0	.29	-163	12.0	3.98	65	-15.8	.163	26	.16	157	1.02
2.5	.34	-176	10.3	3.26	55	-15.2	.174	28	.16	150	1.06
3.0	.41	169	8.7	2.71	42	-14.8	.181	25	.15	143	1.10
3.5	.46	157	7.2	2.31	30	-14.2	.194	22	.13	144	1.11
4.0	.49	146	6.1	2.01	18	-13.8	.203	20	.10	156	1.13
4.5	.52	135	5.0	1.77	7	-13.4	.215	17	.09	173	1.14
5.0	.54	123	4.1	1.60	-3	-12.9	.226	15	.09	-178	1.14

Features

- Up or Down Frequency Conversion with up to 20 dB Conversion Gain
- RF Input from 0.5 to 8.0 GHz
- Low Phase Noise Self-Oscillating LO from 0.5 to 8.0 GHz Using External Tank Circuit
- Downconverted IF Output from DC to 2.0 GHz
- Uniform Performance
- Low Power Consumption per Function
- Low Cost per Function

Description

The MSF-88 Series is a family of silicon bipolar Monolithic Microwave Integrated Circuit (MMIC) Frequency Converters. These MMIC's are characterized as simple, 2-port active mixers with low power injected LO. They can also function as self-oscillating active mixers.

The MSF-88 Series is ideally suited for very low cost or size constrained designs where adequate conversion gain flatness, LO-RF and LO-IF isolation or spurious signal rejection can be achieved using simple external filters.

Typical applications include Satellite MATV and TVRO block converters, GPS navigation and INMARSAT receivers, mobile and cellular radio receivers, and communications and radar systems.

The MSF-88 Series is fabricated using a 10 GHz f_T silicon bipolar MMIC process that features sub-micrometer nitride self-alignment and ion-implantation to achieve excellent unit-to-unit uniformity. Biasing requires a fixed single polarity supply with an external current stabilizing resistor.

These MMIC's are offered in package styles suitable for industrial, military and commercial applications; model MSF-8835 is housed in a cost effective, glass sealed ceramic package, model MSF-8870 is in a high reliability, hermetically sealed gold-ceramic package, and model MSF-8885 is in a low cost, plastic package.

Functional Block Diagrams

2-Port Active Mixer

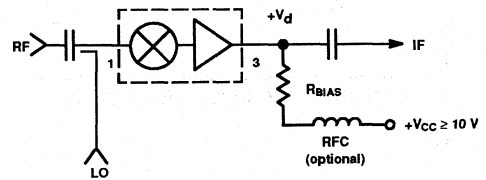

Self-Oscillating Mixer

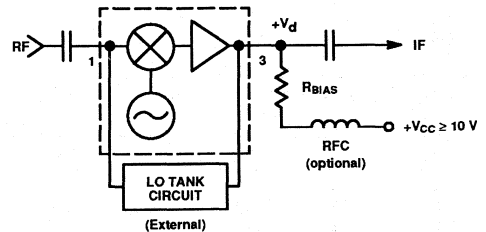

**Electrical Specifications, $T_A = 25^\circ\text{C}$, $I_d = 36 \text{ mA}$,¹ $Z_0 = 50 \Omega$
-20 dBm RF Input at 4.2 GHz and +5 dBm injected² LO at 5.15 GHz**

Symbol	Parameters/Test Conditions	Units	MSF-8835			MSF-8870			MSF-8885		
			Min.	Typ.	Max.	Min.	Typ.	Max.	Min.	Typ.	Max.
G_C	Conversion Gain at 0.95 GHz IF $f = 4.2 \text{ GHz}$	dB	7.5	9.0		7.5	9.0		7.0	8.5	
P_1 dB	Output Power at 1 dB Compression $f = 0.95 \text{ GHz}$	dBm		9.0			9.0			9.0	
IP_3	3rd Order Output Intercept Point $f = 0.95 \text{ GHz}$	dBm		16.0			16.0			16.0	
NF	Single-Side-Band Noise Figure $f = 4.2 \text{ GHz}$	dB		12.0			12.0			13.0	
VSWR	Input VSWR $f = 0.5 \text{ to } 5.0 \text{ GHz}$	-		2.3:1			2.3:1			2.5:1	
	Output VSWR $f = 0.5 \text{ to } 5.0 \text{ GHz}$	-		2.0:1			2.0:1			2.0:1	
V_d	Device Voltage	V	7.0	7.8	8.4	7.0	7.8	8.4	7.0	7.8	8.4
dV/dT	Device Voltage Temp. Coefficient	mV/ $^\circ\text{C}$		-17.0			-17.0			-17.0	

Notes: 1. The recommended operating range for this device is 20 mA to 40 mA. Typical performance as a function of current is on the following page.
2. For the 2-port active mixer application, the LO power is specified at port 1 of the MMIC.

MSF-88 Series Silicon Bipolar MMIC Frequency Converter

Typical Performance, $T_A = 25^\circ\text{C}$

(unless otherwise noted)

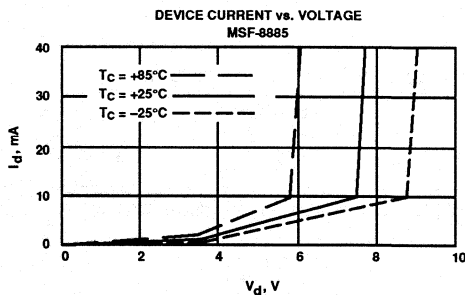
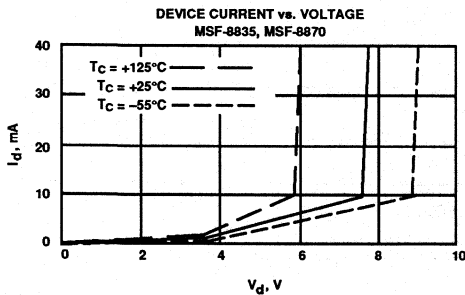
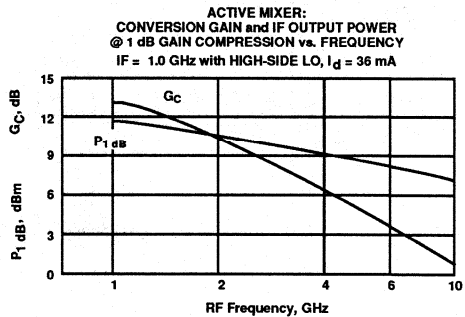
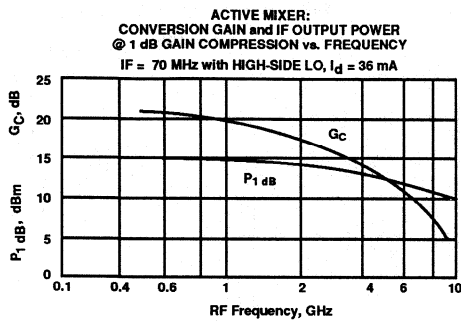
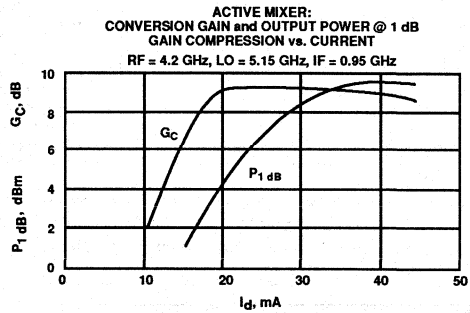
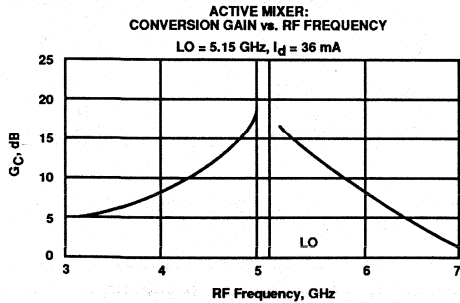

**EXAMPLE OF TVRO BLOCK DOWN CONVERTER USING MSF-88XX SERIES—CONVERSION GAIN = $7.5 \pm .5\text{ dB}$
FROM 3.7-4.2 GHz WITH SELF-OSCILLATING LO AT 5.15 GHz**

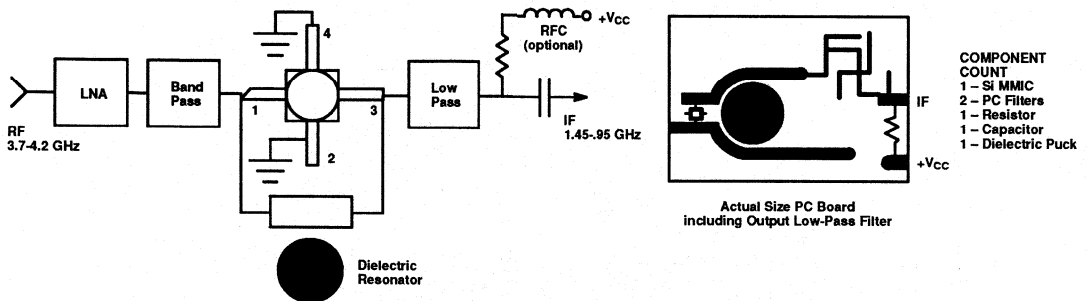

MSF-88 Series Silicon Bipolar MMIC Frequency Converter

Absolute Maximum Ratings

Parameter	Absolute Maximum ¹		
	MSF-8835	MSF-8870	MSF-8885
Device Current	80 mA	80 mA	65 mA
Power Dissipation ^{2,4}	750 mW	750 mW	500 mW
RF Input Power	+20 dBm	+20 dBm	+20 dBm
Junction Temperature	200 °C	200 °C	150 °C
Storage Temperature	200 °C ³	200 °C	150 °C
Thermal Resistance ⁴	175 °C/W	150 °C/W	130 °C/W

Notes:

- Permanent damage may occur if any of these limits are exceeded.
- Derate at 5.7 mW/°C for T_C > 69°C (MSF-8835); 6.7 mW/°C for T_C > 88°C (MSF-8870); 7.7 mW/°C for T_C > 85°C (MSF-8885).
- Storage above +150°C may tarnish the leads of this package making it difficult to solder into a circuit.
- T_{CASE} = 25°C.

MSF-8835 Avantek micro-X package

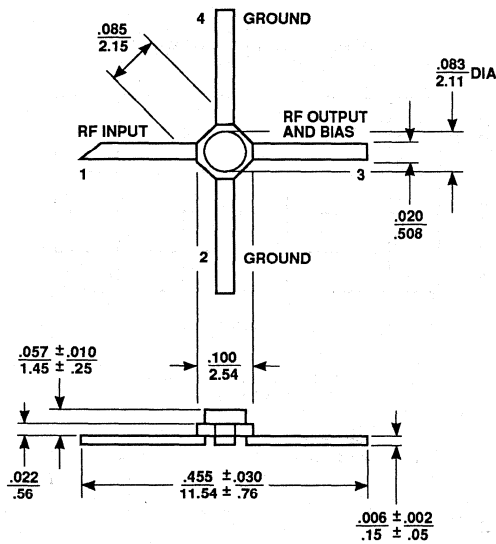

MSF-8870 Avantek 70 mil package

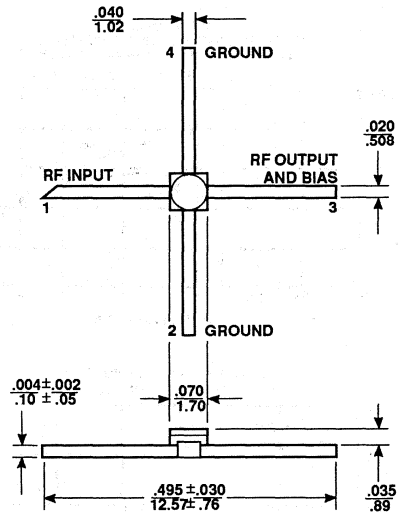

MSF-8885 Avantek 85 mil plastic package

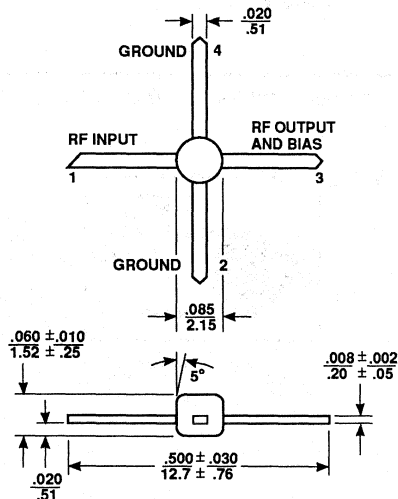

Notes:

- Dimensions are in $\frac{\text{in}}{\text{mm}}$
- Tolerances (unless otherwise specified)
in: .xxx = ±.005
mm: .xx = ±.13

**MSF-88 Series Silicon Bipolar
MMIC Frequency Converter**

Typical Scattering Parameters: MSF-8835

T_A = 25°C, I_d = 36 mA

Freq. GHz	S ₁₁		S ₂₁			S ₁₂			S ₂₂		k
	Mag	Ang	dB	Mag	Ang	dB	Mag	Ang	Mag	Ang	
0.1	.63	-17	32.5	42.02	161	-37.7	.013	55	.63	-19	0.72
0.2	.58	-33	31.5	37.52	145	-33.7	.021	47	.56	-37	0.73
0.4	.49	-56	29.1	28.50	119	-29.7	.033	54	.42	-66	0.72
0.6	.40	-70	26.7	21.54	103	-27.9	.040	55	.32	-84	0.78
0.8	.35	-80	24.6	17.01	92	-26.0	.050	53	.24	-98	0.85
1.0	.33	-89	22.9	13.98	82	-24.9	.057	52	.18	-107	0.89
1.5	.30	-111	19.5	9.45	64	-22.1	.079	51	.09	-126	0.95
2.0	.30	-133	16.9	7.03	48	-20.2	.098	44	.07	-141	0.99
2.5	.32	-150	14.9	5.53	39	-19.2	.110	42	.06	-166	1.04
3.0	.34	-170	13.2	4.56	26	-18.3	.122	36	.06	-106	1.06
3.5	.38	175	11.7	3.86	14	-17.5	.133	32	.08	-100	1.08
4.0	.39	162	10.5	3.33	2	-16.7	.146	27	.12	-101	1.08
5.0	.41	132	7.9	2.47	-21	-15.6	.165	19	.21	-113	1.10
6.0	.52	95	5.8	1.94	-45	-14.6	.187	7	.20	-149	1.05

Typical Scattering Parameters: MSF-8870

T_A = 25°C, I_d = 36 mA

Freq. GHz	S ₁₁		S ₂₁			S ₁₂			S ₂₂		k
	Mag	Ang	dB	Mag	Ang	dB	Mag	Ang	Mag	Ang	
0.1	.65	-19	32.5	42.04	161	-36.3	.015	40	.64	-22	0.78
0.2	.60	-35	31.5	37.54	145	-33.7	.021	47	.58	-43	0.66
0.4	.48	-60	29.1	28.49	122	-30.5	.030	51	.47	-74	0.64
0.6	.40	-76	26.8	21.90	108	-28.0	.040	50	.38	-97	0.72
0.8	.35	-88	24.9	17.48	97	-26.2	.049	50	.33	-113	0.78
1.0	.32	-102	23.4	14.85	87	-24.9	.057	51	.28	-128	0.83
1.5	.29	-118	20.1	10.14	70	-23.0	.071	47	.22	-151	0.91
2.0	.30	-133	17.6	7.55	56	-21.9	.081	45	.16	-167	0.98
2.5	.31	-139	15.6	6.01	49	-20.0	.100	46	.12	-172	1.02
3.0	.32	-149	13.8	4.87	39	-19.5	.106	41	.07	-170	1.11
3.5	.34	-158	12.2	4.09	28	-18.4	.121	35	.07	-143	1.12
4.0	.34	-168	10.8	3.48	17	-17.7	.131	31	.12	-112	1.16
5.0	.33	161	8.4	2.63	-3	-16.6	.147	21	.19	-103	1.26
6.0	.39	128	6.2	2.04	-22	-16.2	.155	10	.21	-115	1.36

Typical Scattering Parameters: MSF-8885

T_A = 25°C, I_d = 36 mA

Freq. GHz	S ₁₁		S ₂₁			S ₁₂			S ₂₂		k
	Mag	Ang	dB	Mag	Ang	dB	Mag	Ang	Mag	Ang	
0.1	.64	-21	32.5	42.29	160	-36.5	.015	40	.61	-24	0.78
0.2	.58	-39	31.3	36.89	144	-32.8	.023	50	.54	-45	0.67
0.4	.44	-65	28.7	27.20	120	-29.4	.034	54	.42	-77	0.69
0.6	.36	-82	26.3	20.57	106	-27.2	.044	53	.33	-98	0.77
0.8	.31	-95	24.3	16.31	96	-25.2	.055	53	.28	-115	0.83
1.0	.27	-105	22.5	13.36	87	-24.2	.061	51	.25	-129	0.87
1.5	.24	-125	19.3	9.24	71	-21.4	.085	50	.18	-153	0.96
2.0	.26	-147	16.7	6.82	56	-19.7	.103	47	.15	-173	0.98
2.5	.29	-159	14.9	5.57	48	-18.4	.120	44	.12	180	1.00
3.0	.34	-175	13.1	4.51	37	-17.7	.130	42	.09	165	1.03
3.5	.38	172	11.6	3.80	25	-16.9	.144	37	.06	172	1.04
4.0	.42	161	10.1	3.21	14	-16.3	.153	33	.04	-139	1.06
5.0	.48	135	7.7	2.43	-7	-15.6	.167	24	.09	-90	1.09
6.0	.60	102	5.5	1.88	-29	-14.9	.179	17	.08	-140	1.06

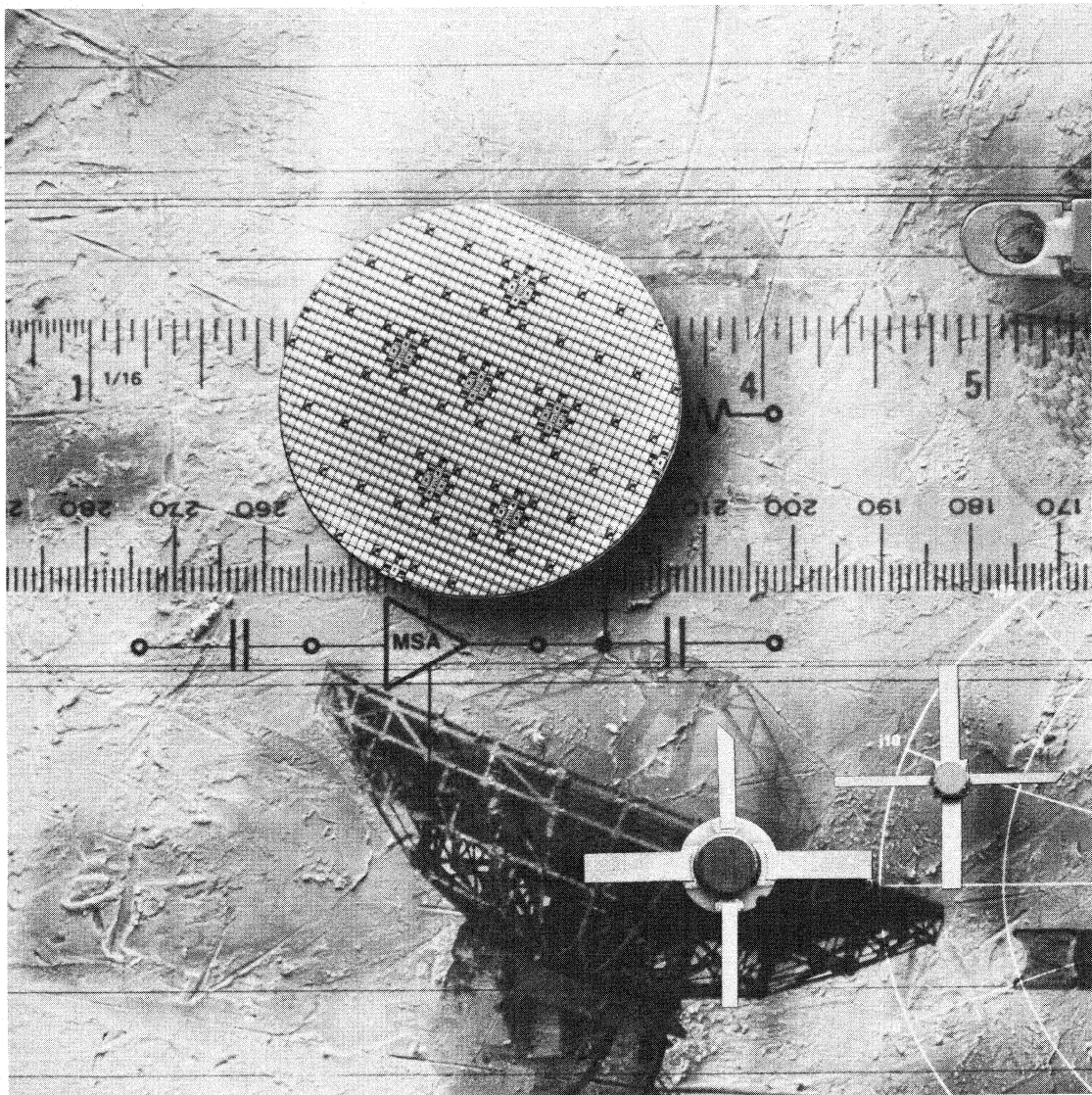

Gallium Arsenide Monolithic Microwave Integrated Circuits

SELECTION GUIDE	5-2
MGA-SERIES PRODUCTS	5-3

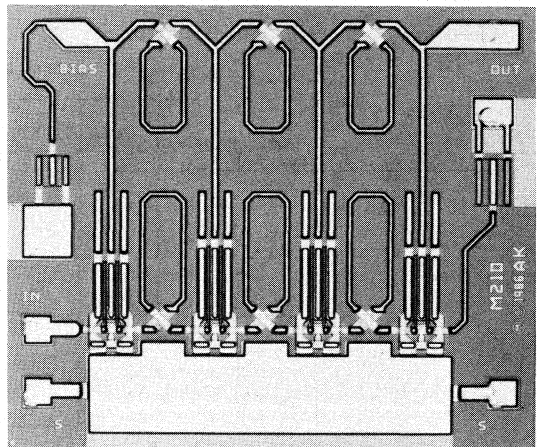
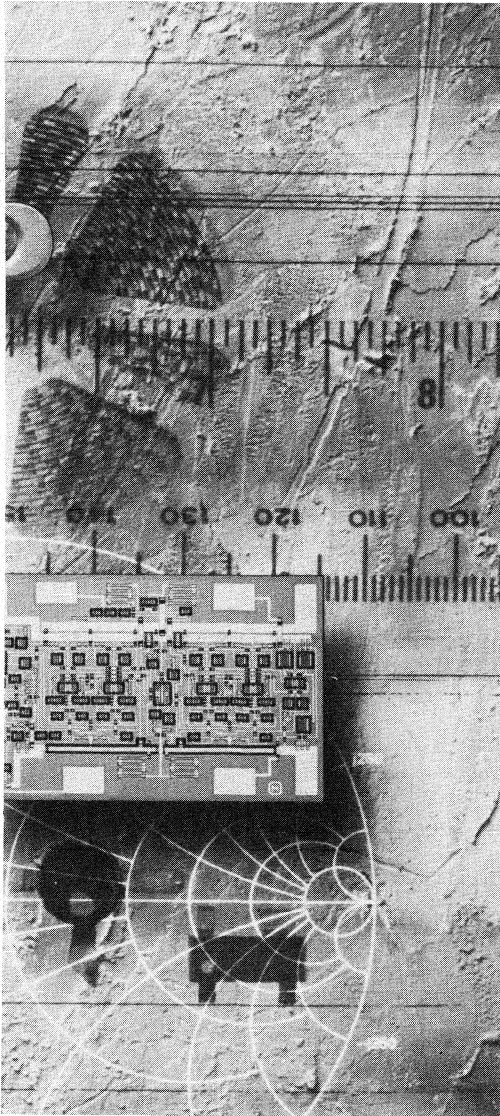

GaAs MONOLITHIC MICROWAVE INTEGRATED CIRCUITS

GENERAL PURPOSE AMPLIFIERS

(Typical Specifications @ 25°C Case Temperature)

Model	Bandwidth (GHz)	G _p (dB)	ΔG _p (dB)	NF (dB)	P ₁ dB (dBm)	Case Type	Page Number
MGA-61000	2-18	7.0	±0.5	6.0	14.0	Chip	5-3
MGA-61100	6-18	7.0	±0.5	6.0	14.0	Chip	5-6
MGA-64135	2-6	12.0	±0.8	7.5	12.0	micro-X	5-15

LOW NOISE AMPLIFIERS

(Typical Specifications @ 25°C Case Temperature)

Model	Optimum Frequency Range (GHz)	Test Frequency (GHz)	G _p (dB)	NF (dB)	P ₁ dB (dBm)	Case Type	Page Number
MGA-62100	2-14	4	14.0	2.5	12.5	Chip	5-9

MEDIUM POWER FET CASCADES

(Typical Specifications @ 25°C Case Temperature)

Model	Range (GHz)	Test Frequency (GHz)	P ₁ dB ⁽¹⁾ (dBm)	G ₁ dB ⁽¹⁾ (dB)	Case Type	Page Number
MGA-63100	6-18	14	22.0	10.5	Chip	5-12
MGA-65100	2-18	14	24.0	9.5	Chip	5-17

Note: 1. Tuned measurement.

TYPICAL PERFORMANCE: GaAs MMICs @ T_A = 25°C

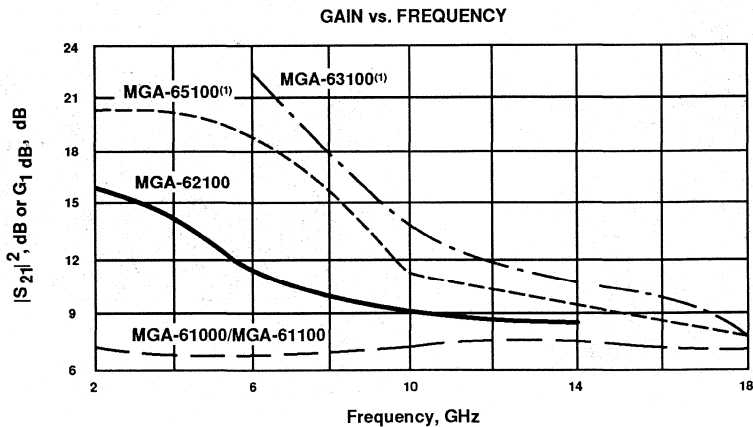

Note: 1. 1 dB Compressed Gain.

Features

- Cascadable 50 Ω Gain Block
- Broadband Performance: 2-18 GHz
 7.0 dB typical Gain
 ± 0.5 dB typical Gain Flatness
- 14.0 dBm typical P_{1 dB} at 18 GHz
- Single Supply Bias

Description

Avantek's MGA-61000 is a high performance gallium arsenide Monolithic Microwave Integrated Circuit (MMIC) chip designed for use as a broadband high frequency gain stage in industrial and military applications.

This MMIC is a distributed amplifier utilizing dual gate FETs, resulting in a fully matched gain block useful in the 2 to 18 GHz frequency range. An external self-bias source resistor allows for bias flexibility from a single positive power supply.

The die is fabricated using Avantek's nominal .3 micron recessed Schottky-barrier-gate, gold metallization, and silicon nitride passivation to achieve excellent performance, uniformity, and reliability.

Avantek Chip Outline

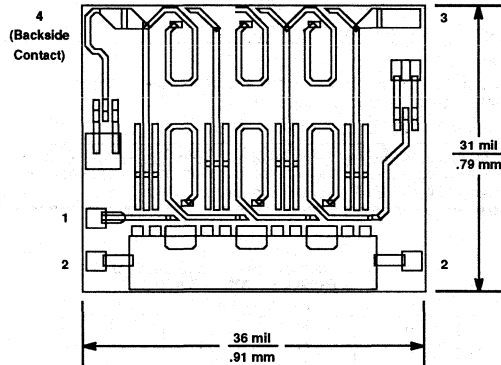

Chip Schematic

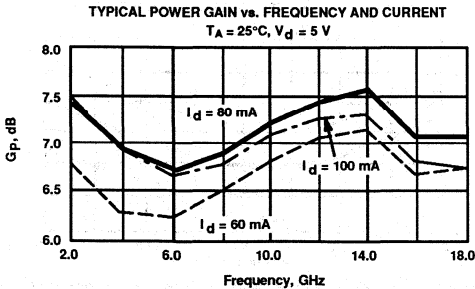
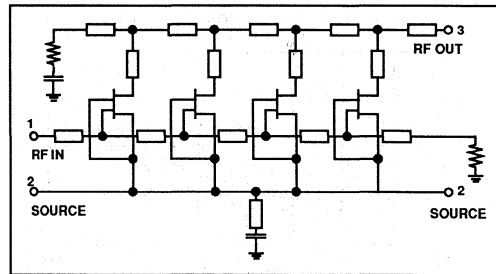

Electrical Specifications, $T_A = 25^\circ\text{C}$

Symbol	Parameters and Test Conditions: $V_d = 5\text{ V}; Z_0 = 50\ \Omega$	Units	Min. ¹	Typ.	Max. ¹
G _P	Power Gain ($ S_{21} ^2$) f = 2 to 18 GHz	dB	6.0	7.0	
ΔG_P	Gain Flatness f = 2 to 18 GHz	dB		+0.5	±0.75
VSWR	Input VSWR f = 2 to 18 GHz				2.0:1
	Output VSWR f = 2 to 18 GHz				2.0:1
-	Reverse Isolation ($ S_{21} ^2$) f = 2 to 18 GHz	dB		30	
NF	50 Ω Noise Figure f = 2 to 18 GHz	dB		6.0	
P _{1 dB}	Output Power @ 1 dB Gain Compression $V_d = 6\text{ V}$ f = 2 to 18 GHz	dBm		14	
IP ₃	Third Order Intercept Point $V_d = 6\text{ V}, f = 18\text{ GHz}$	dBm		20	
I _d	Device Current	mA	60	80	100

Note: 1. RF performance is determined by assembling and testing 10 devices per wafer.

MGA-61000

GaAs MMIC Amplifier

Absolute Maximum Ratings

Parameter	Absolute Maximum ¹
Device Voltage	7.0 V
Total Power Dissipation ²	600 mW
CW RF Input Power	+20 dBm
Channel Temperature	175°C
Storage Temperature	-65°C to +175°C

Thermal Resistance: $\theta_{jc} = 60^\circ\text{C/W}$; $T_{CH} = 150^\circ\text{C}$
 Liquid Crystal Measurement; $1 \mu\text{m}$ spot size³

Notes:

- Operation of this device above any one of these parameters may cause permanent damage.
- Derate linearly at $16.7 \text{ mW}/^\circ\text{C}$ for $T_A > 139^\circ\text{C}$.
- The small spot size of this technique results in a higher, though more accurate determination of θ_{jc} than do alternate methods. See MEASUREMENTS section for more information.

Part Number Ordering Information

Part Number	Devices Per Tray
MGA-61000-GP0	1
MGA-61000-GP2	10
MGA-61000-GP6	Up to 300

Typical Performance

POWER GAIN vs. FREQUENCY AND TEMPERATURE

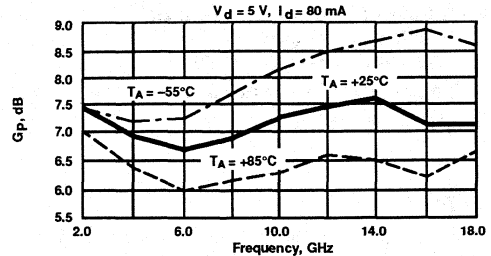

POWER OUTPUT @ 1 dB GAIN COMPRESSION vs. FREQUENCY AND CURRENT

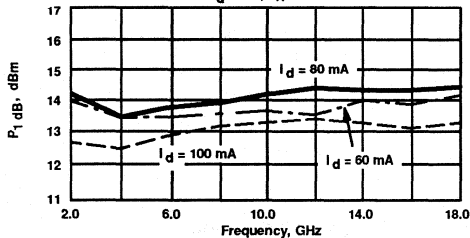

POWER OUTPUT @ 1 dB GAIN COMPRESSION vs. FREQUENCY AND TEMPERATURE

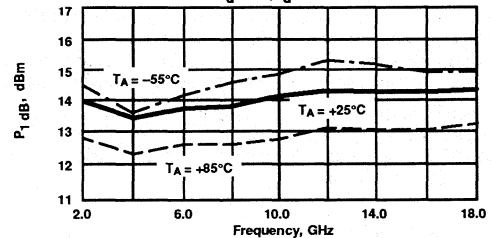

NOISE FIGURE vs. FREQUENCY AND CURRENT

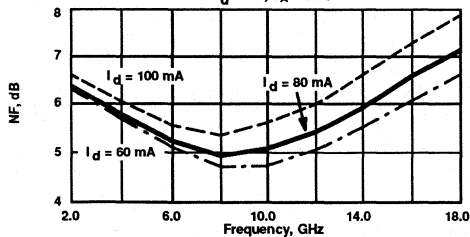

NOISE FIGURE vs. FREQUENCY AND TEMPERATURE

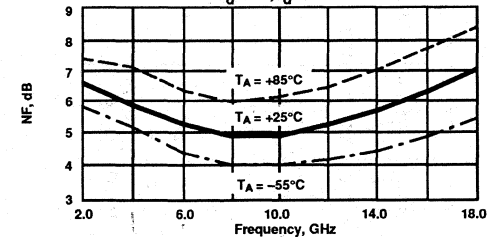

Typical Scattering Parameters: $Z_0 = 50 \Omega$

$T_A = 25^\circ\text{C}, V_d = 5 \text{ V}, I_d = 80 \text{ mA}$

Freq. GHz	S_{11}		dB	S_{21}		dB	S_{12}		S_{22}	
	Mag	Ang		Mag	Ang		Mag	Ang	Mag	Ang
2.0	.15	143	7.4	2.36	145	-37.9	.013	59	.25	-130
3.0	.14	138	7.2	2.28	124	-35.4	.017	56	.17	-163
4.0	.15	134	6.9	2.22	105	-34.0	.020	47	.14	165
5.0	.16	126	6.8	2.19	86	-33.3	.022	39	.13	137
6.0	.16	118	6.8	2.18	68	-33.4	.021	31	.12	113
7.0	.16	111	6.8	2.20	50	-34.0	.020	24	.11	88
8.0	.16	106	6.9	2.22	32	-35.0	.018	20	.10	64
9.0	.15	103	7.0	2.25	13	-36.5	.015	15	.10	39
10.0	.15	105	7.2	2.30	-6	-38.4	.012	16	.10	17
11.0	.17	106	7.4	2.34	-27	-38.8	.011	21	.09	3
12.0	.19	104	7.4	2.36	-48	-38.0	.013	19	.07	-3
13.0	.22	98	7.4	2.35	-68	-36.5	.015	10	.06	19
14.0	.24	90	7.6	2.39	-88	-34.1	.020	-10	.08	46
15.0	.26	77	7.4	2.36	-111	-31.0	.028	-35	.15	51
16.0	.24	62	7.0	2.26	-133	-28.5	.037	-67	.21	41
17.0	.19	52	6.8	2.20	-154	-26.9	.045	-94	.24	31
18.0	.09	64	7.0	2.26	-173	-28.2	.039	-122	.24	39

Features

- Cascadable 50 Ω Gain Block
- Broadband Performance: 6-18 GHz
 7.0 dB typical Gain
 ± 0.5 dB typical Gain Flatness
- 14.0 dBm typical P_{1 dB} at 18 GHz
- Single Supply Bias

Description

Avantek's MGA-61100 is a high performance gallium arsenide Monolithic Microwave Integrated Circuit (MMIC) chip designed for use as a broadband high frequency gain stage in industrial and military applications.

This MMIC is a distributed amplifier utilizing dual gate FETs, resulting in a fully matched gain block useful in the 6 to 18 GHz frequency range. An external self-bias source resistor allows for bias flexibility from a single positive power supply.

The die is fabricated using Avantek's nominal .3 micron recessed Schottky-barrier-gate, gold metallization, and silicon nitride passivation to achieve excellent performance, uniformity, and reliability.

Avantek Chip Outline

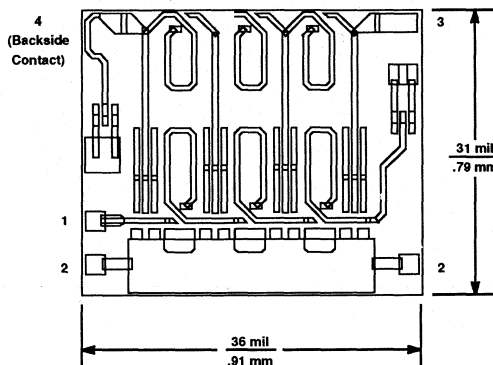

Chip Schematic

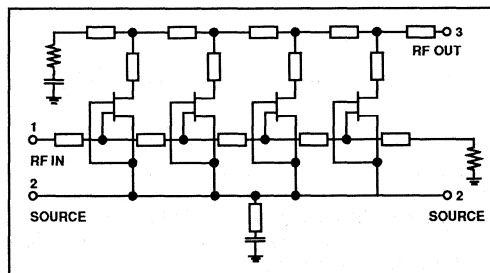

TYPICAL POWER GAIN vs. FREQUENCY AND CURRENT
 T_A = 25°C, V_d = 5 V

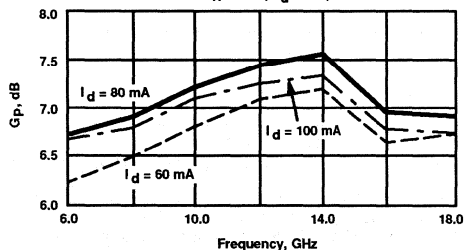

Electrical Specifications, T_A = 25°C

Symbol	Parameters and Test Conditions: V _d = 5 V; Z _O = 50 Ω	Units	Min. ¹	Typ.	Max. ¹
G _P	Power Gain (S ₂₁ ²)	f = 6 to 18 GHz	6.0	7.0	
ΔG _P	Gain Flatness	f = 6 to 18 GHz		±0.5	±0.75
VSWR	Input VSWR	f = 6 to 18 GHz			2.0:1
	Output VSWR	f = 6 to 18 GHz			2.0:1
-	Reverse Isolation (S ₂₁ ²)	f = 6 to 18 GHz		30	
NF	50 Ω Noise Figure	f = 6 to 18 GHz		6.0	
P _{1 dB}	Output Power @ 1 dB Gain Compression V _d = 6 V	f = 6 to 18 GHz		14.0	
IP ₃	Third Order Intercept Point	V _d = 6 V, f = 18 GHz		20	
I _d	Device Current		60	80	100

Note: 1. RF performance is determined by assembling and testing 10 devices per wafer.

Absolute Maximum Ratings

Parameter	Absolute Maximum ¹
Device Voltage	7.0 V
Total Power Dissipation ²	600 mW
CW RF Input Power	+20 dBm
Channel Temperature	175°C
Storage Temperature	-65°C to +175°C

Thermal Resistance: $\theta_{jc} = 60^\circ\text{C/W}$; $T_{CH} = 150^\circ\text{C}$
Liquid Crystal Measurement; 1 μm spot size³

Notes:

1. Operation of this device above any one of these parameters may cause permanent damage.
2. Derate linearly at 16.7 mW/°C for $T_A > 139^\circ\text{C}$.
3. The small spot size of this technique results in a higher, though more accurate determination of θ_{jc} than do alternate methods. See MEASUREMENTS section for more information.

Part Number Ordering Information

Part Number	Devices Per Tray
MGA-61100-GP0	1
MGA-61100-GP2	10
MGA-61100-GP6	Up to 300

Typical Performance

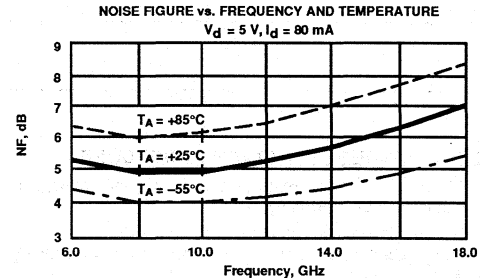
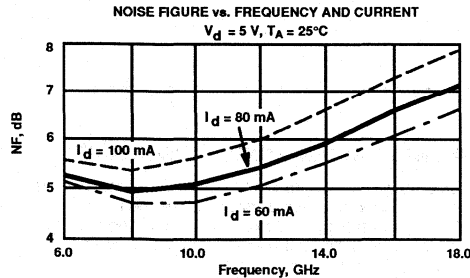
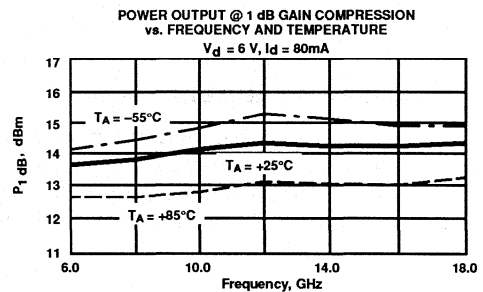
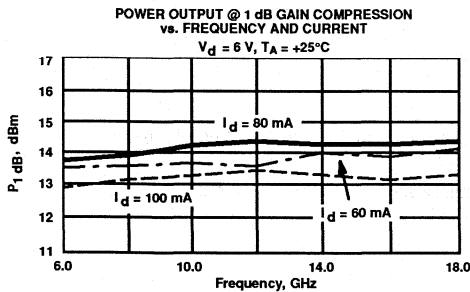
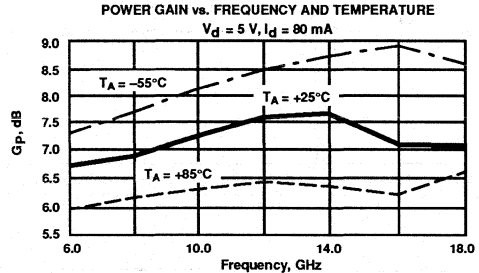

Typical Scattering Parameters: $Z_0 = 50\ \Omega$

$T_A = 25^\circ\text{C}, V_d = 5\text{ V}, I_d = 80\text{ mA}$

Freq. GHz	S ₁₁		S ₂₁		S ₁₂			S ₂₂		
	Mag	Ang	dB	Mag	dB	Mag	Ang	Mag	Ang	
6.0	.16	118	6.8	2.18	68	-33.4	.021	31	.12	113
7.0	.16	111	6.8	2.20	50	-34.0	.020	24	.11	88
8.0	.16	106	6.9	2.22	32	-35.0	.018	20	.10	64
9.0	.15	103	7.0	2.25	13	-36.5	.015	15	.10	39
10.0	.15	105	7.2	2.30	-6	-38.4	.012	16	.10	17
11.0	.17	106	7.4	2.34	-27	-38.8	.011	21	.09	3
12.0	.19	104	7.4	2.36	-48	-38.0	.013	19	.07	-3
13.0	.22	98	7.4	2.35	-68	-36.5	.015	10	.06	19
14.0	.24	90	7.6	2.39	-88	-34.1	.020	-10	.08	46
15.0	.26	77	7.4	2.36	-111	-31.0	.028	-35	.15	51
16.0	.24	62	7.0	2.26	-133	-28.5	.037	-67	.21	41
17.0	.19	52	6.8	2.20	-154	-26.9	.045	-94	.24	31
18.0	.09	64	7.0	2.26	-173	-28.2	.039	-122	.24	39

Typical Biasing Configuration

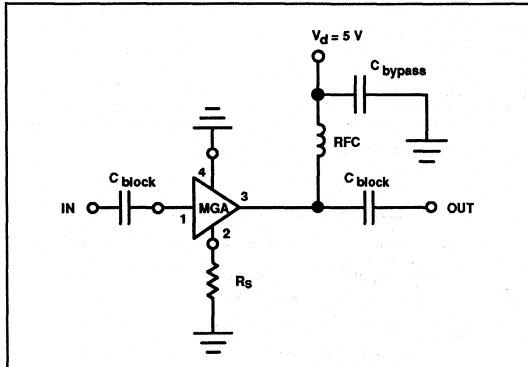

Substrate Bonding Diagram

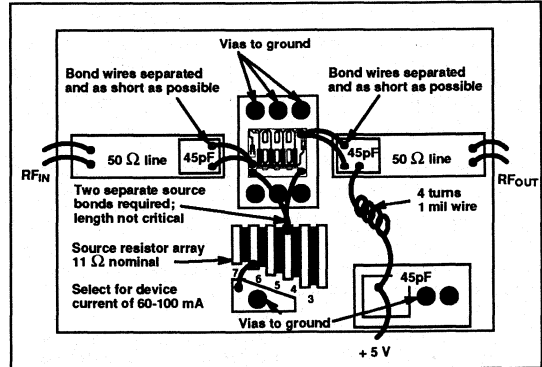

EXTERNAL ELEMENTS REQUIRED:

- Source Resistor Array (R_s): Select resistor for device current of 60-100 mA (11 Ω nominal).
- Input and Output DC Blocking Capacitors: 45 pF typical.
- RF Choke Network and Bypass Capacitor: 4 turns 1 mil wire; 45 pF capacitor typical.
- Input and Output RF Transmission Lines: 50 Ω typical.

RECOMMENDED DIE ATTACH PROCEDURE

1. Die attach should be performed under an inert atmosphere of either nitrogen or forming gas.
2. Set heater block temperature to $300 \pm 10^\circ\text{C}$.
3. Place circuit on heater block and heat thoroughly; typically 5 - 15 seconds.
4. Place Au-Sn preform on circuit in die attach location, using sufficient quantity to ensure wetting and to produce a fillet around the die.
5. Using sharp tweezers, pickup the die and orient it properly on the circuit.
6. Scrub the die into the preform with a back-and-forth motion taking care not to scratch the top surface of the chip. Continue until wetting occurs; normally within 3 to 4 scrubs.
7. Wetting should occur on 100% of the chip perimeter to form a visible fillet around the die.
8. Remove the circuit from the heater block and allow it to cool in air. Total time for die attach should be less than 10 seconds.

RECOMMENDED WEDGE BONDING PROCEDURE

1. Set heater block temperature to $260 \pm 10^\circ\text{C}$ (If the wedge is heated, the heater block temperature should be lowered slightly from this setting. The exact setting will need to be determined empirically, and will vary from machine to machine).
2. Use prestressed (annealed) gold wire of .0007 or .001 inches diameter.
3. Tip bonding pressure should be between 15 and 20 grams, and should not exceed 20 grams. The footprint left by the wire should be between 1.5 and 2.5 wire diameters across.
4. Proceed with bonding according to machine instructions. Bonds should be made from the circuit to the chip bonding pads to minimize the potential for pad damage. Bonds should be made to the source (common) and drain (output) pads of the MMIC before bonding to the gate (input) pad to minimize the potential for ESD damage.

CAUTION: This device makes use of GaAs FET devices with very small gate geometries. Such devices are subject to damage by electro-static discharge (ESD), and must only be handled by properly grounded personnel working at grounded assembly stations.

Features

- **Output Matched 2 Stage FET Cascade**
- **Broadband Performance: 2 - 14 GHz**
- **Low Noise Figure (50 Ω):**
 2.5 dB typical at 4 GHz
 5.0 dB typical at 14 GHz
- **8.5 dB typical Gain at 14 GHz**
- **Single Supply Bias**

Description

Avantek's MGA-62100 is a high performance gallium arsenide Monolithic Microwave Integrated Circuit (MMIC) chip designed for use as a broadband high frequency gain stage in industrial and military applications in the 2 to 14 GHz frequency band.

This MMIC consists of a two FET cascade with feedback around the output stage to yield an output matched structure. Flexibility is maintained by having the input match provided externally by the user. AC grounded sources and an internal resistive network allow for biasing from a single positive power supply. The source grounding capacitor for the input stage is an external element to allow for extended low frequency performance.

The die is fabricated using Avantek's nominal .3 micron recessed Schottky-barrier-gate, gold metallization, and silicon nitride passivation to achieve excellent performance, uniformity, and reliability.

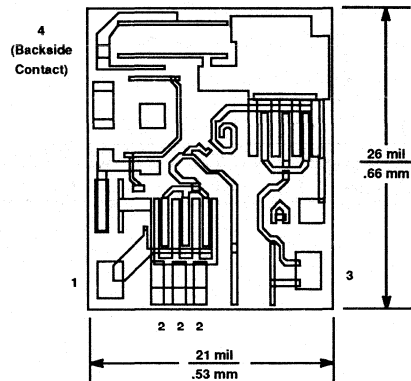
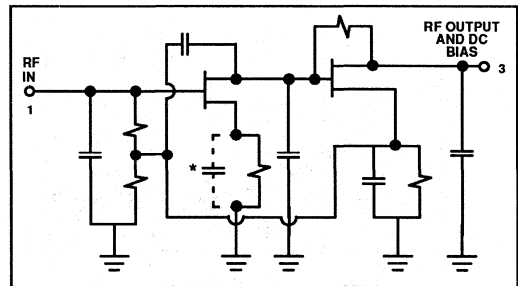
Avantek Chip Outline

Chip Schematic

*This capacitor is an off-chip element selected by the user to get lower frequency performance.

Electrical Specifications, T_A = 25°C

Symbol	Parameters and Test Conditions: V _d = 10 V, Z ₀ = 50 Ω	Units	Min. ¹	Typ.	Max. ¹
G _p	Power Gain (S ₂₁ ²) f = 4.0 GHz f = 10.0 GHz f = 14.0 GHz	dB	7.5	14.0 9.0 8.5	
NF	50 Ω Noise Figure f = 4.0 GHz f = 10.0 GHz f = 14.0 GHz	dB		2.5 4.0 5.0	
P ₁ dB	Output Power @ 1 dB Gain Compression f = 4.0 GHz f = 10.0 GHz f = 14.0 GHz	dBm		12.5 11.5 14.0	
VSWR	Output VSWR f = 2 to 14 GHz			1.6:1	
—	Reverse Isolation f = 2 to 14 GHz	dB		33.0	
I _d	Device Current	mA	55	65	80

Note 1. RF performance is determined by assembling and testing 10 devices per wafer.

MGA-62100
GaAs MMIC Amplifier

Absolute Maximum Ratings

Parameter	Absolute Maximum ¹
Device Voltage	10.0 V
Total Power Dissipation ²	640 mW
CW RF Input Power	+14 dBm
Channel Temperature	175°C
Storage Temperature	-65°C to 175°C

Thermal Resistance: $\theta_{jc} = 100^\circ\text{C/W}$; $T_{CH} = 150^\circ\text{C}$
Liquid Crystal Measurement; 1 μm spot size³

Notes:

1. Operation of this device above any one of these parameters may cause permanent damage.
2. Derate linearly at 10 mW/°C for $T_A > 111^\circ\text{C}$.
3. The small spot size of this technique results in a higher, though more accurate determination of θ_{jc} than do alternate methods. See MEASUREMENTS section for more information.

Part Number Ordering Information

Part Number	Devices Per Tray
MGA-62100-GP0	1
MGA-62100-GP2	10
MGA-62100-GP6	Up to 300

Typical Performance, $T_A = 25^\circ\text{C}$

(unless otherwise noted)

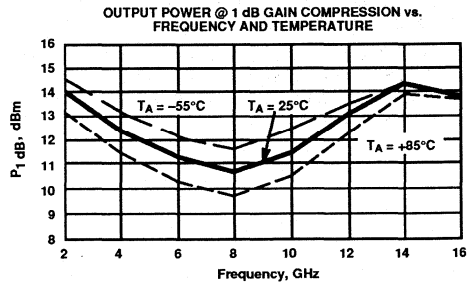
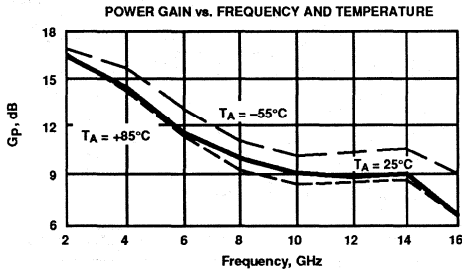
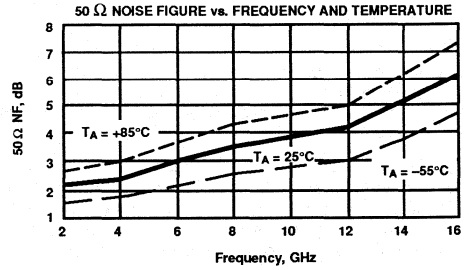

Typical Scattering Parameters: $Z_0 = 50 \Omega$

$T_A = 25^\circ\text{C}$, $V_d = 8 \text{ V}$

Freq. GHz	S_{11}		S_{21}			S_{12}			S_{22}	
	Mag	Ang	dB	Mag	Ang	dB	Mag	Ang	Mag	Ang
2.0	.85	-41	16.2	6.42	-46	-39.1	.011	49	.14	-177
3.0	.79	-56	15.4	5.91	-78	-37.4	.013	57	.16	126
4.0	.70	-75	14.3	5.19	-111	-36.3	.015	66	.20	96
5.0	.62	-94	12.9	4.40	-139	-35.5	.017	66	.23	81
6.0	.58	-109	11.6	3.80	-162	-35.5	.017	69	.24	72
7.0	.55	-123	10.7	3.41	175	-34.8	.018	75	.22	66
8.0	.52	-132	9.9	3.11	159	-34.5	.019	83	.20	61
9.0	.50	-146	9.2	2.89	140	-34.1	.020	85	.17	47
10.0	.50	-159	9.0	2.80	120	-33.5	.021	86	.16	30
11.0	.49	-175	8.9	2.78	98	-33.1	.022	80	.17	18
12.0	.53	164	8.8	2.76	75	-33.2	.022	69	.16	18
13.0	.62	147	8.8	2.76	50	-33.6	.021	48	.12	41
14.0	.71	139	8.7	2.73	29	-35.1	.018	21	.15	98
15.0	.75	124	8.2	2.56	-3	-35.6	.017	-26	.33	109
16.0	.75	111	6.4	2.09	-39	-34.6	.019	-76	.53	98

Typical Biasing Configuration

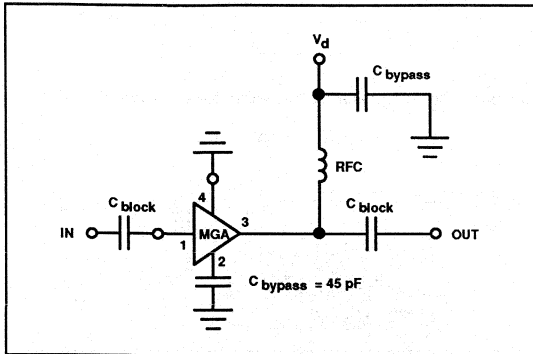

Substrate Bonding Diagram

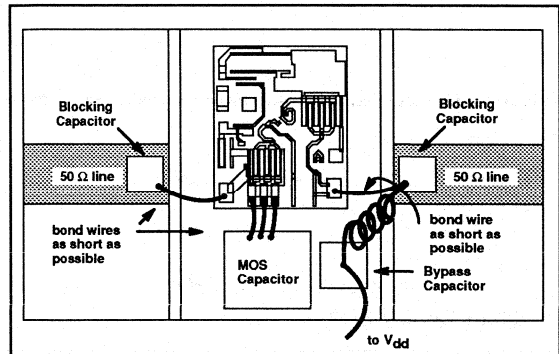

EXTERNAL ELEMENTS REQUIRED:

- Source Bypass Capacitor: 45 pF typical
- Input and Output DC Blocking Capacitors: 45 pF typical
- RF Choke Network and Bypass Capacitor: 4 turns 1 mil wire; 45 pF typical
- Input and Output RF Transmission Lines: 50 Ω typical

OPTIONAL EXTERNAL ELEMENTS/SPECIAL USE:

- Input Impedance Matching Network: Device guarantees and typical performance are with a 50 Ω generator impedance. Input matching can be used with the MMIC, either to improve noise figure slightly in a narrow band of operation, or to improve the input VSWR and increase the gain at the cost of some loss in noise figure.

RECOMMENDED DIE ATTACH PROCEDURE

1. Die attach should be performed under an inert atmosphere of either nitrogen or forming gas.
2. Set heater block temperature to $300 \pm 10^\circ\text{C}$.
3. Place circuit on heater block and heat thoroughly; typically 5 - 15 seconds.
4. Place Au-Sn preform on circuit in die attach location, using sufficient quantity to ensure wetting and to produce a fillet around the die.
5. Using sharp tweezers, pick up the die and orient it properly on the circuit.
6. Scrub the die into the preform with a back-and-forth motion taking care not to scratch the top surface of the chip. Continue until wetting occurs; normally within 3 to 4 scrubs.
7. Wetting should occur on 100% of the chip perimeter to form a visible fillet around the die.
8. Remove the circuit from the heater block and allow it to cool in air. Total time for die attach should be less than 10 seconds.

RECOMMENDED WEDGE BONDING PROCEDURE

1. Set heater block temperature to $260 \pm 10^\circ\text{C}$ (If the wedge is heated, the heater block temperature should be lowered slightly from this setting. The exact setting will need to be determined empirically, and will vary from machine to machine).
2. Use prestressed (annealed) gold wire of .0007 or .001 inches diameter.
3. Tip bonding pressure should be between 15 and 20 grams, and should not exceed 20 grams. The footprint left by the wire should be between 1.5 and 2.5 wire diameters across.
4. Proceed with bonding according to machine instructions. Bonds should be made from the circuit to the chip bonding pads to minimize the potential for pad damage. Bonds should be made to the source (common) and drain (output) pads of the MMIC before bonding to the gate (input) pad to minimize the potential for ESD damage.

CAUTION: This device makes use of GaAs FET devices with very small gate geometries. Such devices are subject to damage by electro-static discharge (ESD), and must only be handled by properly grounded personnel working at grounded assembly stations.

Features

- Unmatched 2 Stage FET Cascade
- High Output Power:
22 dBm typical $P_{1\text{ dB}}$ at 14 GHz
- High Gain:
10.5 dB typical $G_{1\text{ dB}}$ at 14 GHz
- Single Supply Bias

Description

Avantek's MGA-63100 is a high performance gallium arsenide Monolithic Microwave Integrated Circuit (MMIC) chip designed for use as a broadband high frequency gain stage in industrial and military applications.

This MMIC uses a cascade of two FET pairs to yield a device with higher gain and higher input impedance than a conventional discrete FET. AC grounded sources and an internal resistive network allow for biasing from a single positive power supply.

The die is fabricated using Avantek's nominal .3 micron recessed Schottky-barrier-gate, gold metallization, and silicon nitride passivation to achieve excellent performance, uniformity, and reliability.

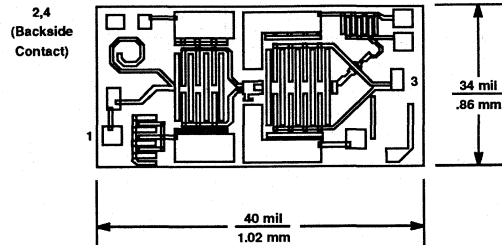
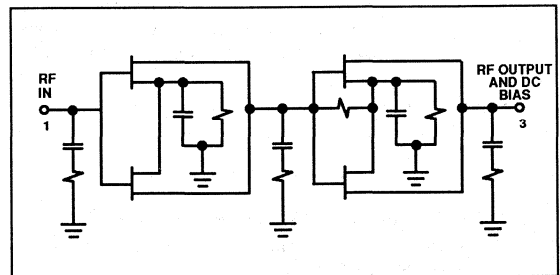
Avantek Chip Outline

Chip Schematic

Electrical Specifications, $T_A = 25^\circ\text{C}$

Symbol	Parameters and Test Conditions: $V_d = 10\text{ V}$, $Z_O = 50\ \Omega$	Units	Min. ¹	Typ.	Max. ¹
$P_{1\text{ dB}}^2$	Power Output @ 1 dB Gain Compression $f = 6.0\text{ GHz}$ $f = 14.0\text{ GHz}$ $f = 18.0\text{ GHz}$	dBm	20.0	21.0 22.0 21.0	
$G_{1\text{ dB}}^2$	1 dB Compressed Gain $f = 6.0\text{ GHz}$ $f = 14.0\text{ GHz}$ $f = 18.0\text{ GHz}$	dB	8.0	22.5 10.5 7.5	
P_{SAT}^2	Saturated Output Power (3 dB Compressed) $f = 14.0\text{ GHz}$	dB		25.0	
—	Reverse Isolation $f = 14.0\text{ GHz}$	dB		30.0	
I_d	Device Current	mA	100	150	200

Notes: 1. RF performance is determined by assembling and testing 10 devices per wafer.
2. Tuned Measurement.

Absolute Maximum Ratings

Parameter	Absolute Maximum ¹
Device Voltage	12.0 V
Total Power Dissipation ²	2.0 W
CW RF Input Power	+25 dBm
Channel Temperature	175°C
Storage Temperature	-65°C to -175°C

Thermal Resistance: $\theta_{jc} = 33^\circ\text{C/W}$; $T_{CH} = 150^\circ\text{C}$
Liquid Crystal Measurement; 1 μm spot size³

Notes:

1. Operation of this device above any one of these parameters may cause permanent damage.
2. Derate linearly at 30 mW/°C for $T_A > 109^\circ\text{C}$.
3. The small spot size of this technique results in a higher, though more accurate determination of θ_{jc} than do alternate methods. See MEASUREMENTS section for more information.

Part Number Ordering Information

Part Number	Devices Per Tray
MGA-63100-GP0	1
MGA-63100-GP2	10
MGA-63100-GP6	Up to 300

Typical Performance, $T_A = 25^\circ\text{C}$

(unless otherwise noted)

1 dB COMPRESSED GAIN vs. FREQUENCY
 $V_d = 10\text{ V}$

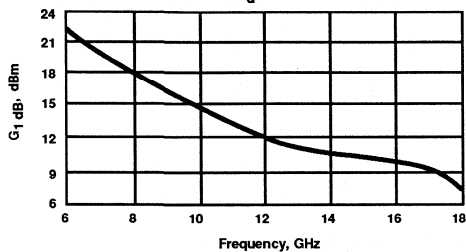

OUTPUT POWER @ 1 dB COMPRESSION vs. FREQUENCY
 $V_d = 10\text{ V}$

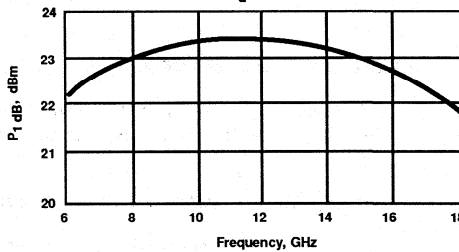

OUTPUT POWER vs. INPUT POWER
 $f = 14\text{ GHz}$, $V_d = 10\text{ V}$

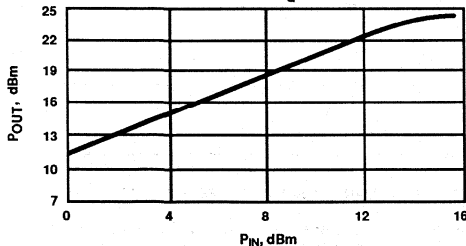

INSERTION POWER GAIN, MAXIMUM AVAILABLE GAIN AND MAXIMUM STABLE GAIN vs. FREQUENCY
 $V_d = 10\text{ V}$

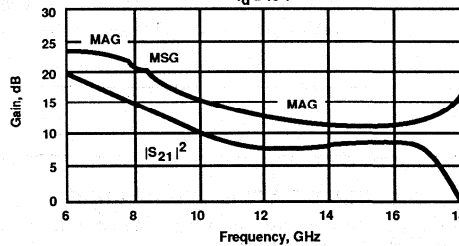

Typical Scattering Parameters: $Z_O = 50\ \Omega$

$T_A = 25^\circ\text{C}$, $V_d = 10\text{ V}$

Freq. GHz	S_{11}		S_{21}			S_{12}			S_{22}		k
	Mag	Ang	dB	Mag	Ang	dB	Mag	Ang	Mag	Ang	
4.0	.89	130	8.6	2.14	92	37.7	.013	86	.44	-93	3.03
5.0	.93	106	13.2	4.56	5	95.0	.016	60	.58	-115	1.39
6.0	.63	40	19.9	9.85	-66	-37.1	.014	110	.59	-144	1.81
7.0	.60	-122	19.8	9.77	-155	-29.6	.033	108	.44	-168	1.08
8.0	.82	-178	15.2	5.74	156	-28.4	.038	94	.37	-169	0.92
9.0	.83	155	11.8	3.88	131	-27.5	.042	79	.39	-170	1.12
10.0	.83	138	10.0	3.17	106	-27.3	.043	65	.41	-177	1.31
11.0	.81	124	8.7	2.73	83	-27.3	.043	59	.42	-179	1.59
12.0	.80	109	8.1	2.53	61	-27.7	.041	48	.44	176	1.80
13.0	.74	89	7.8	2.45	36	-28.6	.037	35	.47	168	2.34
14.0	.61	68	7.7	2.42	10	-30.5	.030	18	.50	163	3.56
15.0	.33	48	7.5	2.37	-20	-34.9	.018	11	.56	157	7.34
16.0	.05	134	8.3	2.59	-63	-43.1	.007	13	.65	145	15.87
17.0	.32	-159	6.9	2.21	-106	-37.1	.014	65	.73	128	6.56
18.0	.71	168	-1.6	0.83	-149	-36.5	.015	49	.74	117	8.53

Typical Biasing Configuration

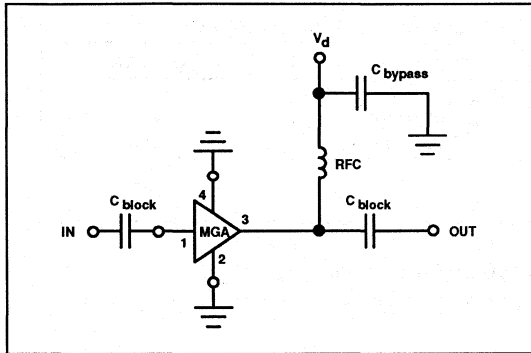

Substrate Bonding Diagram

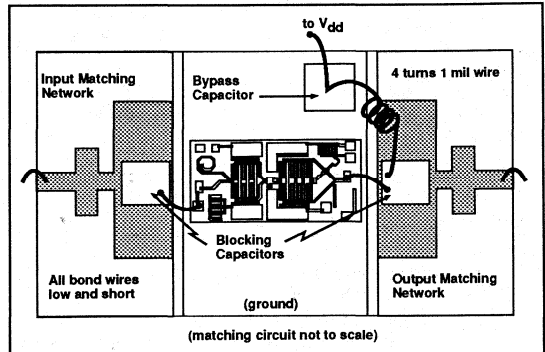

EXTERNAL ELEMENTS REQUIRED:

- Input and Output DC Blocking Capacitors: 45pF typical
- RF Choke Network and Bypass Capacitor: 4 turns 1 mil wire; 45 pF capacitor typical

INPUT and OUTPUT IMPEDANCE MATCHING NETWORKS:

- This MMIC is not impedance matched. As with a discrete transistor, the S-parameter data provided should be used to design input and output impedance matching networks that will optimize device performance for the designer's application. All device guarantees and typical performance information represents performance of the MMIC in a tuned (optimally matched) environment.

RECOMMENDED DIE ATTACH PROCEDURE

1. Die attach should be performed under an inert atmosphere of either nitrogen or forming gas.
2. Set heater block temperature to $300 \pm 10^\circ\text{C}$.
3. Place circuit on heater block and heat thoroughly; typically 5 - 15 seconds.
4. Place Au-Sn preform on circuit in die attach location, using sufficient quantity to ensure wetting and to produce a fillet around the die.
5. Using sharp tweezers, pickup the die and orient it properly on the circuit.
6. Scrub the die into the preform with a back-and-forth motion taking care not to scratch the top surface of the chip. Continue until wetting occurs; normally within 3 to 4 scrubs.
7. Wetting should occur on 100% of the chip perimeter to form a visible fillet around the die.
8. Remove the circuit from the heater block and allow it to cool in air. Total time for die attach should be less than 10 seconds.

RECOMMENDED WEDGE BONDING PROCEDURE

1. Set heater block temperature to $260 \pm 10^\circ\text{C}$ (If the wedge is heated, the heater block temperature should be lowered slightly from this setting. The exact setting will need to be determined empirically, and will vary from machine to machine).
2. Use prestressed (annealed) gold wire of .0007 or .001 inches diameter.
3. Tip bonding pressure should be between 15 and 20 grams, and should not exceed 20 grams. The footprint left by the wire should be between 1.5 and 2.5 wire diameters across.
4. Proceed with bonding according to machine instructions. Bonds should be made from the circuit to the chip bonding pads to minimize the potential for pad damage. Bonds should be made to the source (common) and drain (output) pads of the MMIC before bonding to the gate (input) pad to minimize the potential for ESD damage.

CAUTION: This device makes use of GaAs FET devices with very small gate geometries. Such devices are subject to damage by electro-static discharge (ESD), and must only be handled by properly grounded personnel working at grounded assembly stations.

Features

- Cascadable 50 Ω Gain Block
- Broadband Performance: 2-6 GHz
 12.0 dB typical Gain
 ± 0.8 dB Gain Flatness
 12.0 dBm P_{1 dB}
- Single Supply Bias
- Cost Effective Ceramic Microstrip Package

Description

Avantek's MGA-64135 is a high performance gallium arsenide Monolithic Microwave Integrated Circuit (MMIC) housed in a cost effective, microstrip package. This device is designed for use as a general purpose 50 ohm gain block in the 2 to 6 GHz frequency range. Typical applications include narrow and broadband IF and RF amplifiers for commercial, industrial, and military requirements.

This MMIC is a cascade of two stages, each utilizing shunt feedback to establish a broadband impedance match. The source of each stage is AC grounded to allow biasing from a single positive power supply. The interstage blocking capacitor as well as a resistive "self-bias" network are included on chip.

The die is fabricated using Avantek's nominal .5 micron recessed Schottky-barrier-gate, gold metallization and silicon nitride passivation to achieve excellent performance, uniformity, and reliability.

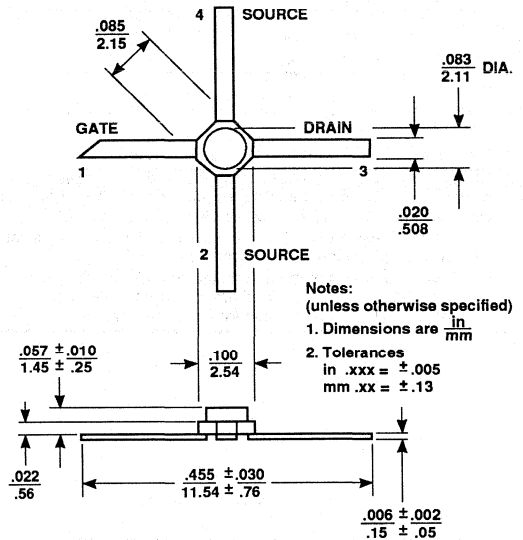
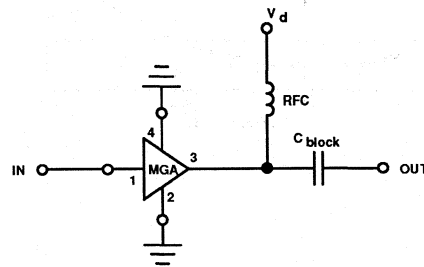
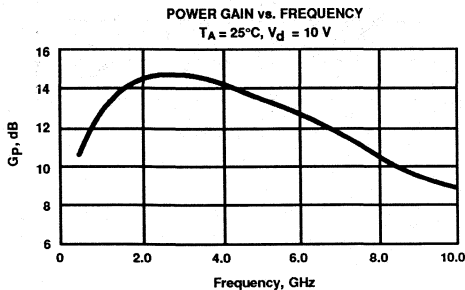
Avantek 35 Micro-X Package

Typical Biasing Configuration

Electrical Specifications, T_A = 25°C

Symbol	Parameters and Test Conditions: V _d = 10 V, Z ₀ = 50 Ω	Units	Min.	Typ.	Max.
G _p	Power Gain (S ₂₁ ²)	f = 2 to 6 GHz	10.0	12.0	
Δ G _p	Gain Flatness	f = 2 to 6 GHz		± 0.8	
-	Gain Variation vs. Temperature T _{CASE} = -25°C to +85°C	f = 2 to 6 GHz		± 0.5	
VSWR	Input VSWR	f = 2 to 6 GHz		1.5:1	2.0:1
	Output VSWR	f = 2 to 6 GHz		1.4:1	2.0:1
P _{1 dB}	Output Power @ 1 dB Gain Compression	f = 2 to 6 GHz	10.0	12.0	
NF	50 Ω Noise Figure	f = 2 to 2 GHz		7.5	
-	Reverse Isolation (S ₁₂ ²)	f = 2 to 6 GHz		35	
I _d	Device Current		35	50	65

MGA-64135 Gallium Arsenide Monolithic Microwave Integrated Circuit Amplifier

Absolute Maximum Ratings

Parameter	Absolute Maximum ¹
Device Voltage	12 V
Total Power Dissipation ²	600 mW
CW RF Input Power	+13 dBm
Channel Temperature	175°C
Storage Temperature ³	-65°C to +175°C

Thermal Resistance: $\theta_{jc} = 150^\circ\text{C}/\text{W}^4$; $T_{CH} = 150^\circ\text{C}$
 Liquid Crystal Measurement; 1 μm spot size⁵

Notes:

- Operation of this device above any one of these parameters may cause permanent damage.
- Derate linearly at 8.3 mW/°C for TCASE > 103°C.
- Storage above +150°C may tarnish the leads of this package making it difficult to solder into a circuit. After a device has been soldered into a circuit it may be safely stored up to 175°C.
- The thermal resistance value is based on measurements taken with the device soldered to a 25 mil Teflon PCB.
- The small spot of this technique results in a higher, though more accurate determination of θ_{jc} than do alternate methods. See MEASUREMENTS section for more information.

Typical Performance, $T_A = 25^\circ\text{C}$

(unless otherwise noted)

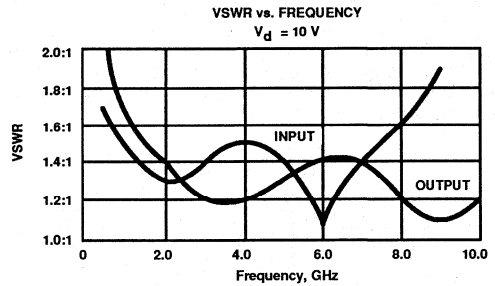
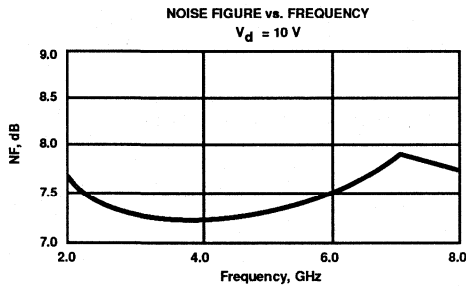
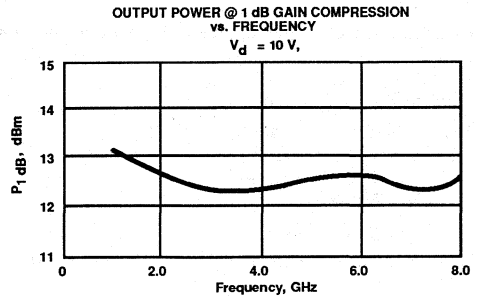

Typical Scattering Parameters: $Z_0 = 50\ \Omega$

$T_A = 25^\circ\text{C}$, $V_d = 10\text{ V}$

Freq. GHz	S ₁₁		S ₂₁			S ₁₂			S ₂₂	
	Mag	Ang	dB	Mag	Ang	dB	Mag	Ang	Mag	Ang
0.5	.27	-38	10.6	3.38	14	-31.0	.028	-13	.38	-41
1.0	.18	-44	12.9	4.42	-9	-33.1	.022	-20	.26	-48
2.0	.14	-67	14.3	5.21	-54	-34.9	.018	-19	.16	-59
3.0	.17	-91	14.5	5.33	-93	-37.1	.014	-21	.11	-75
4.0	.20	-105	14.2	5.11	-131	-37.8	.013	-15	.11	-71
5.0	.18	-114	13.6	4.79	-167	-37.3	.014	-10	.14	-57
6.0	.07	-162	12.8	4.35	157	-38.5	.012	-1	.17	-41
7.0	.15	96	11.8	3.89	123	-36.0	.016	3	.16	-42
8.0	.23	76	10.8	3.46	92	-34.3	.019	4	.10	-54
9.0	.32	63	9.5	2.98	63	-29.3	.034	12	.04	159
10.0	.43	52	8.6	2.68	38	-27.6	.041	-11	.09	116

Features

- Unmatched 2 Stage FET Cascade
- High Output Power:
24 dBm typical $P_{1\text{ dB}}$ at 14 GHz
- High Gain:
9.5 dB typical $G_{1\text{ dB}}$ at 14 GHz
- Single Supply Bias

Description

Avantek's MGA-65100 is a high performance gallium arsenide Monolithic Microwave Integrated Circuit (MMIC) chip designed for use as a medium power high frequency gain stage in industrial and military applications.

This MMIC uses a cascade of two FET pairs to yield a device with higher gain and higher input impedances than a conventional discrete FET. AC grounded sources and an internal resistive network allow for biasing from a single positive power supply.

The die is fabricated using Avantek's nominal .3 micron recessed Schottky-barrier-gate, gold metallization, and silicon nitride passivation to achieve excellent performance, uniformity, and reliability.

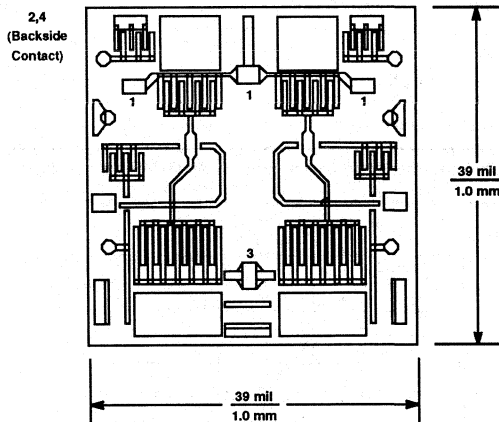
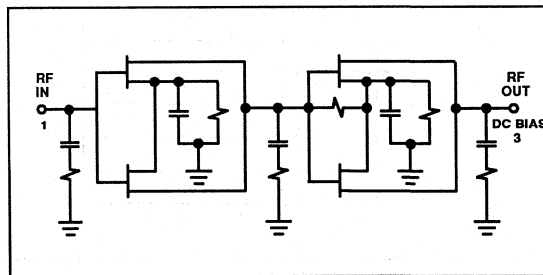
Avantek Chip Outline

Chip Schematic

Electrical Specifications, $T_A = 25^\circ\text{C}$

Symbol	Parameters and Test Conditions: $V_d = 10\text{ V}$, $Z_0 = 50\ \Omega$	Units	Min. ¹	Typ.	Max. ¹
$P_{1\text{ dB}}^2$	Power Output @ 1 dB Gain Compression $f = 6.0\text{ GHz}$ $f = 14.0\text{ GHz}$ $f = 18.0\text{ GHz}$	dBm	23.0	26.0 24.0 22.0	
$G_{1\text{ dB}}^2$	1 dB Compressed Gain $f = 6.0\text{ GHz}$ $f = 14.0\text{ GHz}$ $f = 18.0\text{ GHz}$	dB	8.0	19.0 9.5 7.5	
$PSAT^2$	Saturated Output Power (3 dB Compressed) $f = 14.0\text{ GHz}$	dB		25.0	
—	Reverse Isolation $f = 6\text{ to }18\text{ GHz}$	dB		27.0	
I_d	Device Current	mA	150	200	300

Notes: 1. RF performance is determined by assembling and testing 10 devices per wafer.
2. Tuned Measurement.

MGA-65100

2 Stage GaAs FET Cascade

Absolute Maximum Ratings

Parameter	Absolute Maximum ¹
Device Voltage	12.0 V
Total Power Dissipation ²	3.0 W
CW RF Input Power	+26 dBm
Channel Temperature	175°C
Storage Temperature	-65°C to -175°C

Thermal Resistance: $\theta_{jc} = 22^\circ\text{C/W}$; $T_{CH} = 150^\circ\text{C}$
 Liquid Crystal Measurement; 1 μm spot size³

Notes:

1. Operation of this device above any one of these parameters may cause permanent damage.
2. Derate linearly at 45 mW/°C for $T_A > 109^\circ\text{C}$.
3. The small spot size of this technique results in a higher, though more accurate determination of θ_{jc} than do alternate methods. See MEASUREMENTS section for more information.

Part Number Ordering Information

Part Number	Devices Per Tray
MGA-65100-GP0	1
MGA-65100-GP2	10
MGA-65100-GP6	Up to 300

Typical Performance, $T_A = 25^\circ\text{C}$

(unless otherwise noted)

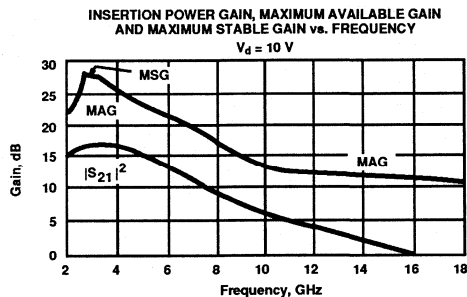
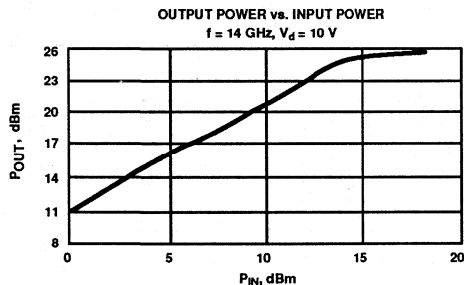
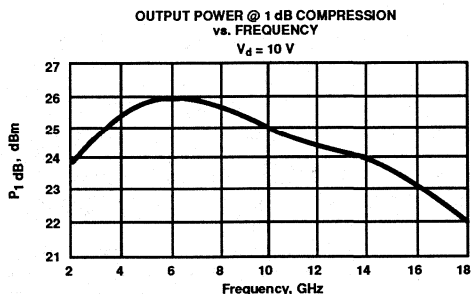
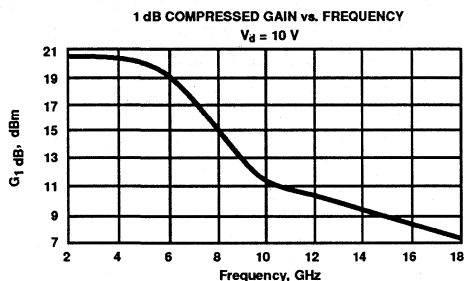

Typical Scattering Parameters: $Z_0 = 50\ \Omega$

$T_A = 25^\circ\text{C}, V_d = 10\text{ V}$

Freq. GHz	S_{11}		S_{21}			S_{12}			S_{22}		k
	Mag	Ang	dB	Mag	Ang	dB	Mag	Ang	Mag	Ang	
2.0	.88	-75	15.0	5.61	-30	-43.1	.007	131	.31	-100	2.59
3.0	.94	-113	16.6	6.75	-74	-40.9	.009	118	.50	-122	0.68
4.0	.93	-136	15.6	6.00	-110	-40.0	.010	55	.61	-143	1.15
5.0	.91	-147	15.9	6.22	-137	-38.4	.012	-5	.61	-157	1.29
6.0	.92	-161	14.0	5.01	176	-38.4	.012	53	.57	-165	1.40
7.0	.92	-170	11.4	3.72	145	-33.2	.022	74	.55	-177	1.13
8.0	.91	-176	9.4	2.96	123	-31.1	.028	73	.54	-167	1.22
9.0	.91	-178	7.8	2.46	102	-29.9	.032	70	.54	-161	1.29
10.0	.90	-173	6.3	2.07	81	-29.1	.035	68	.56	-154	1.44
11.0	.90	-168	5.0	1.77	63	-28.9	.036	65	.57	-148	1.55
12.0	.91	-162	4.2	1.63	45	-28.9	.036	63	.61	-142	1.48
13.0	.91	-157	3.2	1.45	23	-28.4	.038	61	.64	-136	1.46
14.0	.91	-152	2.1	1.27	6	-27.1	.044	58	.69	-127	1.35
15.0	.92	-147	1.4	1.18	-15	-28.0	.040	44	.70	-117	1.22
16.0	.92	-140	0.4	1.05	-38	-28.9	.036	38	.71	-107	1.28
17.0	.93	-134	-1.1	0.88	-63	-29.6	.033	30	.72	-96	1.22
18.0	.93	-131	-2.5	0.75	-85	-30.5	.030	20	.73	-88	1.25

Typical Biasing Configuration

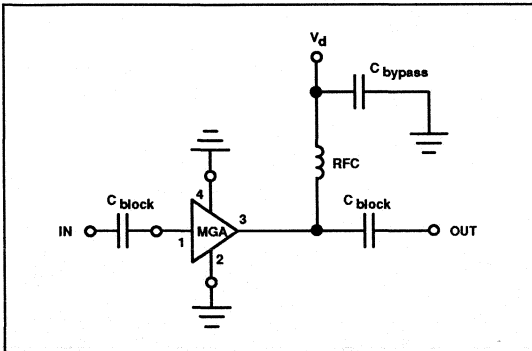

Substrate Bonding Diagram

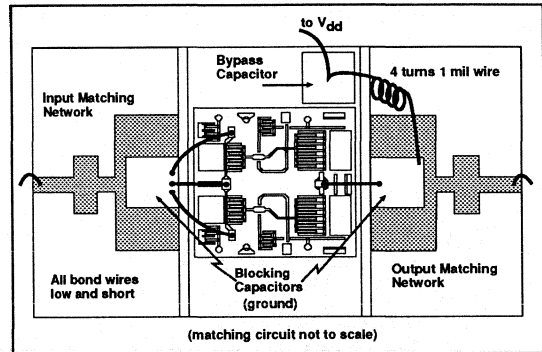

EXTERNAL ELEMENTS REQUIRED:

- Input and Output DC Blocking Capacitors: 45pF typical
- RF Choke Network and Bypass Capacitor: 4 turns 1 mil wire; 45 pF capacitor typical

INPUT and OUTPUT IMPEDANCE MATCHING NETWORKS:

- This MMIC is not impedance matched. As with a discrete transistor, the S-parameter data provided should be used to design input and output impedance matching networks that will optimize device performance for the designer's application. All device guarantees and typical performance information represents performance of the MMIC in a tuned (optimally matched) environment.

RECOMMENDED DIE ATTACH PROCEDURE

1. Die attach should be performed under an inert atmosphere of either nitrogen or forming gas.
2. Set heater block temperature to $300 \pm 10^\circ\text{C}$.
3. Place circuit on heater block and heat thoroughly - typically 5 - 15 seconds.
4. Place Au-Sn preform on circuit in die attach location, using sufficient quantity to ensure wetting and to produce a fillet around the die.
5. Using sharp tweezers, pickup the die and orient it properly on the circuit.
6. Scrub the die into the preform with a back-and-forth motion taking care not to scratch the top surface of the chip. Continue until wetting occurs; normally within 3 to 4 scrubs.
7. Wetting should occur on 100% of the chip perimeter to form a visible fillet around the die.
8. Remove the circuit from the heater block and allow it to cool in air. Total time for die attach should be less than 10 seconds.

RECOMMENDED WEDGE BONDING PROCEDURE

1. Set heater block temperature to $260 \pm 10^\circ\text{C}$ (If the wedge is heated, the heater block temperature should be lowered slightly from this setting. The exact setting will need to be determined empirically, and will vary from machine to machine).
2. Use prestressed (annealed) gold wire of .0007 or 1.000 inches diameter.
3. Tip bonding pressure should be between 15 and 20 grams, and should not exceed 20 grams. The footprint left by the wire should be between 1.5 and 2.5 wire diameters across.
4. Proceed with bonding according to machine instructions. Bonds should be made from the circuit to the chip bonding pads to minimize the potential for pad damage. Bonds should be made to the source (common) and drain (output) pads of the MMIC before bonding to the gate (input) pad to minimize the potential for ESD damage.

CAUTION: This device makes use of GaAs FET devices with very small gate geometries. Such devices are subject to damage by electro-static discharge (ESD), and must only be handled by properly grounded personnel working at grounded assembly stations.

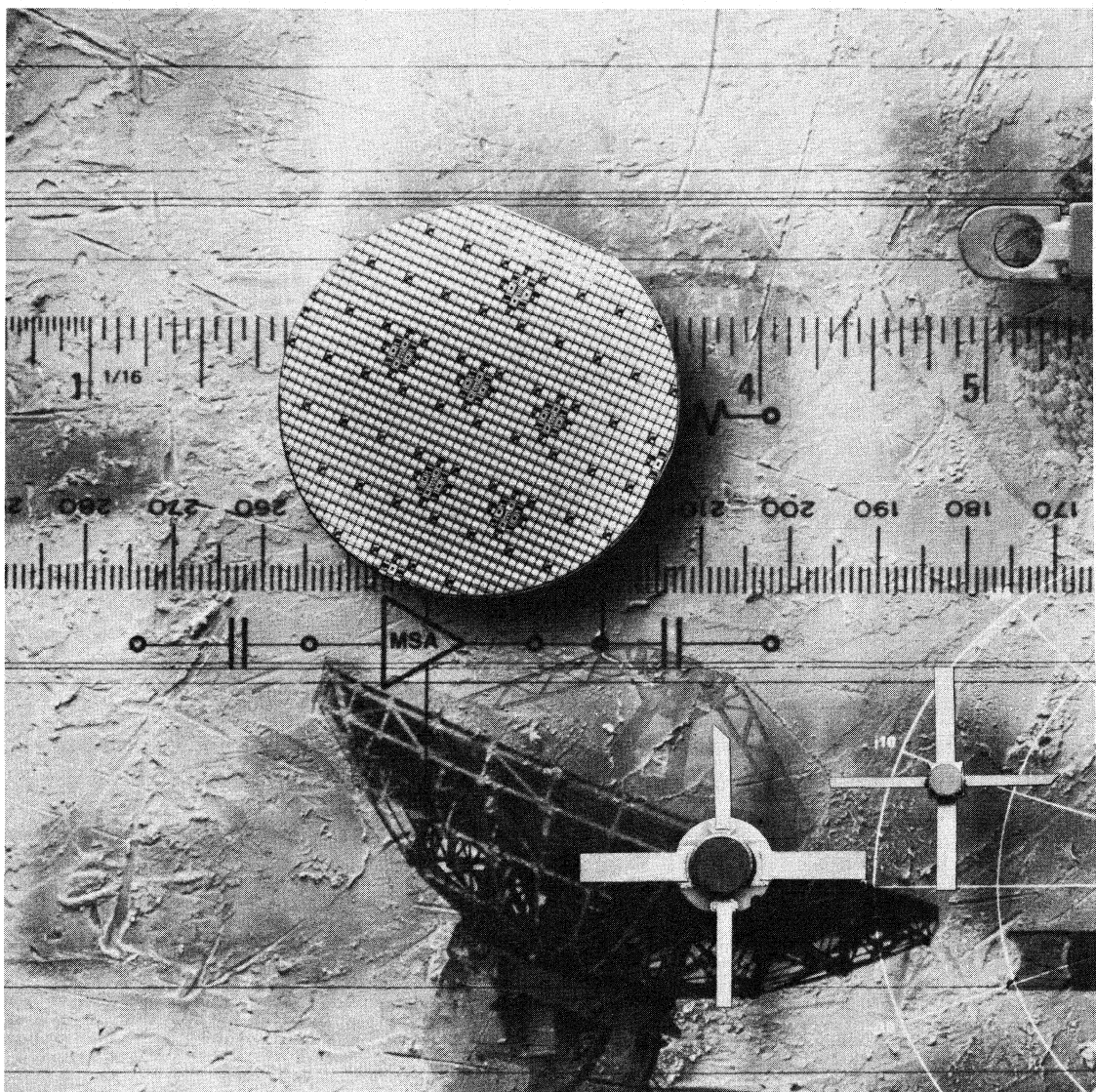

Application Information

SERVICES 6-2

LITERATURE 6-2

APPLICATION NOTE EXTRACTS

- Electrostatic Discharge
Damage and Control 6-3
- Mounting Considerations for
Packaged Microwave
Semiconductors 6-4
- Transistor Chip Use 6-6
- MODAMP Silicon MMIC
Chip Use 6-8
- Biasing MODAMP MMICs 6-10

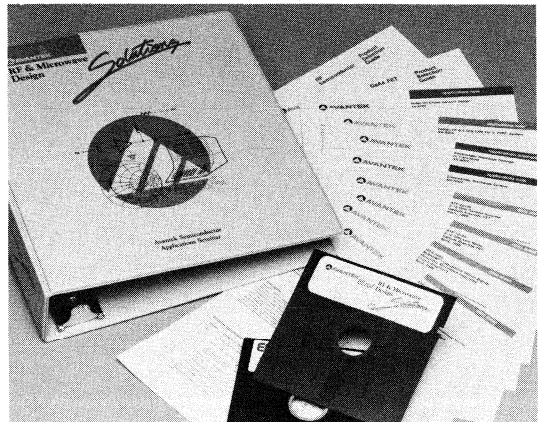
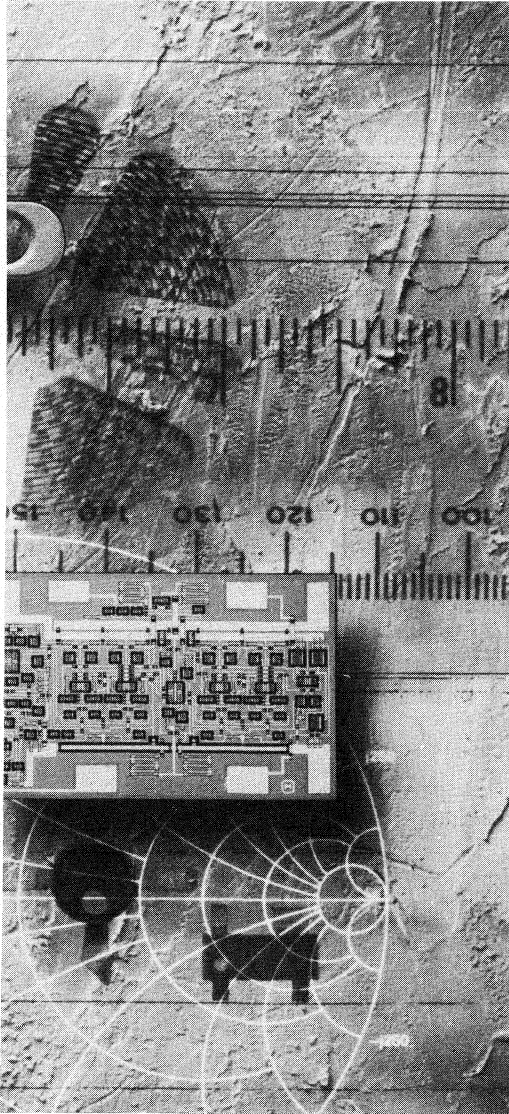

SERVICES

Avantek maintains a Semiconductor Applications Engineering Department to assist customers with the design of microwave semiconductor circuits. This department can support customer designs via telephone including computer MODEM connections. For design assistance or for more information on the services of the Applications Engineering Department, please phone (408) 970-2758 in Santa Clara, CA or (415) 795-5442 in Newark, CA; or, in Dallas, TX, phone (214) 437-5694.

The department has a complete measurements laboratory which is used to verify the data contained in this catalog. In addition, it has a computer-aided design work station with several software packages for both linear and non-linear design. Included in the software library are the following:

Linear Analysis programs:

- TOUCHSTONE™ (EEsof¹)
- STAR (Circuit Busters²)
- AMCAP (Avantek noise and S-parameter program)

Non-Linear Analysis programs:

- MW SPICE™ (EEsof¹)
- P SPICE™ (MicroSim³)

Modem capability:

- CROSSTALK XVI® (MicroStuf⁴)

All of the S-parameter data in this catalog is also available on a computer disk from Avantek, EEsof¹ and COMPACT SOFTWARE.⁵

-
1. EEsof, Inc., 31194 LaBaya Drive, Westlake Village, CA 91362
 2. Circuit Busters, 1750 Mountain Glen, Stone Mountain, GA 30087
 3. MicroSim Corp, 23175 La Cadena Drive, Laguna Hills, CA 92653
 4. Microstuf, Inc. 1000 Holcomb Woods Pkwy., Roswell, GA 30076
 5. COMPACT Software, Inc. 483 McLean Blvd., Patterson, NJ 07504

LITERATURE

A library of Applications Notes is available. It includes a high frequency transistor primer series which provides a basic introduction to microwave semiconductor products and various Applications Notes detailing specific design examples. Contact Avantek or any Authorized Sales Office, Representative or Distributor for copies of any of the following. You may also make your request on the reply card at the back of this Data Book.

High Frequency Transistor Primer Series

- Primer 1 Silicon Bipolar Electrical Characteristics
- Primer 2 Noise & S-Parameter Characterization
- Primer 3 Thermal Properties
- Primer 3A Thermal Resistance
- Primer 4 GaAs FET Characteristics

General Applications Notes

- AN-A001 Notes on Choke Network Design
- AN-A002 Design of a 4 GHz LNA for a TRVO Earth Station
- AN-A003 Electrostatic Discharge Damage in Transistors
- AN-A004 Electrostatic Discharge Control
- AN-A005 Transistor & MOS Chip Use
- AN-A006 Mounting Considerations for Packaged Microwave Semiconductors
- AN-A007 4 GHz Television Receive Only LNB Design
- AN-A008 Microwave Oscillator Design

Silicon Application Notes

- AN-S001 Basic MODAMP MMIC Circuit Techniques
- AN-S002 MODAMP MMIC Nomenclature
- AN-S003 Biasing MODAMP MMICs
- AN-S004 A Broadband IF Amplifier Using MSA-0235 and MSA-0335
- AN-S005 Using Avantek MSF Series Frequency Converters
- AN-S006 Using External Feedback to Achieve Flat Gain with the MSA-0885
- AN-S007 Using the MSA-0520 and MSA-1023 Medium Power MODAMP Silicon MMIC Amplifiers
- AN-S008 Designing with the MSA-9970
- AN-S009 MODAMP Silicon MMIC Chip Use
- AN-S010 A 5 GHz Bipolar Active Mixer

GaAs Application Note

- ATP-1054 Measurement and Modeling of GaAs FET Chips

Additional Literature

Device specific Application Bulletins and the "RF & Microwave Design Solutions" Seminar literature, including a computer disk, are also available. Call (408) 970-2758 for more information.

This is an abstract from Applications Note AN-A004R: Electrostatic Discharge Damage and Control.

Parametric or functional failure of silicon bipolar transistors, GaAs FETs, or MMICs can occur as a result of electrostatic discharge. Failures in bipolar transistors are characterized by low breakdown voltage or high leakage current. FET failures are characterized by resistive shorts. In some cases, leakage current may increase with applied voltage and reduced reverse breakdown voltage.

Static discharge is almost always associated with people, the types of material or clothes that people wear, and the handling equipment that comes into contact with the semiconductor devices.

RECOMMENDATIONS FOR ESD CONTROL

A partial listing of the most common generators of electrostatic charge is as follows:

1. Work stations and areas
 - a. Work benches and surface coverings (non-conductive)
 - b. Floors (vinyl and all waxed surfaces)
 - c. Chairs (ungrounded)
2. Operator clothing
 - a. Clean-room garments (synthetics)
 - b. Personal clothing (synthetics, silk, and wool)
3. Part and assembly packaging materials
 - a. Polyethylene bags and films
 - b. Polyethylene bubble pack and foam
 - c. plastic boxes, trays, and cabinets
4. Cleaning and test areas
 - a. High velocity gas flow temperature chambers for drying

A partial list of corrective measures for use in neutralizing these generators of electrostatic charge is as follows:

1. Work stations and areas
 - a. Use grounded conductive mats and plates over non-conducting surfaces
 - b. Ground conductive surfaces
 - c. Use grounded floor mats
 - d. Apply grounded conductive grids or nets to chairs
 - e. Use electrostatic precipitators in the immediate work area
2. Operator clothing
 - a. Use wrist grounding strap (10 megaohm ground)
 - b. Use static-free smocks
 - c. Use foot-grounded straps on leather soles
 - d. Control of personal clothing may be necessary
3. Part and assembly packaging material
 - a. Use conductive bags and wrapping
 - b. Eliminate the use of bubble pack
 - c. Use shorting collars, rings, or wrappers on individual parts prior to installation
4. Cleaning and test areas
 - a. Eliminate high velocity gas flow over assemblies and parts

Last, but definitely not least, are some common mistakes and problems associated with operator grounding. Some of these problems may be difficult to prevent if not carefully looked into.

1. Remember to place ground straps back on after breaks and lunch before handling any susceptible parts.
2. Be sure that the wrist strap is securely attached to the wrist touching the skin snugly for adequate connection. Wrist straps do not work when attached over clothing.
3. Do not wear smocks or clothing made of materials which tend to generate high electrostatic potentials such as synthetics, wool, or silk.
4. Do not use alligator clips or any other kind of quick-disconnect fasteners to ground the operator to the mat, as they tend to fall off easily.
5. Do not use tangled or knotted ground cords.
6. Do not allow wrist straps to become corroded or dirty from excessive use. They must be cleaned or replaced regularly.

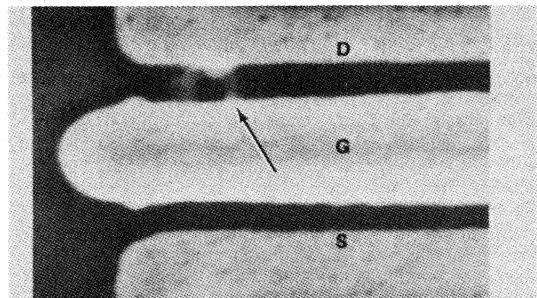

T-Gate Channel with electrostatic damage (5.8KX).

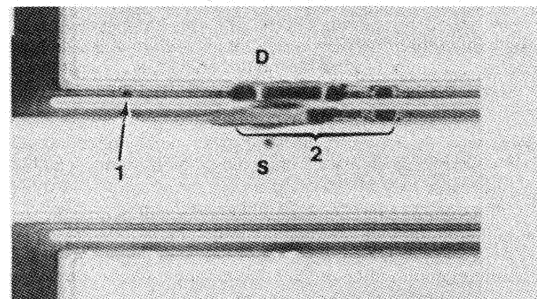

An example of Avantek interdigitated metallization with electrostatic damage. (1) Initial static damage. (2) Side effect of discharge resulting from damage shown in (a).

This is an abstract from Applications Note AN-A006: Mounting Considerations For Packaged Microwave Semiconductors.

This applications note discusses how electrical, mechanical, and thermal connections should be made for packaged microwave devices. There are two primary package types: small signal and power.

SMALL SIGNAL DEVICE PACKAGES

Soldering

Small signal microwave semiconductor packages can use the attachment of the leads to the electrical traces of the circuit board as the sole means of device mounting. Thus the lead attachment provides the mechanical, thermal, and electrical connections to the circuit. The most common way of attaching the leads of a package to a circuit board is by soldering.

The soldering process can subject devices to two different kinds of potentially dangerous stresses: electrical and thermal. A transistor or MMIC can suffer permanent electrical damage if any of its breakdown voltages are exceeded. This can happen when soldering equipment is not properly grounded, therefore **MAKE SURE ALL SOLDERING EQUIPMENT IS AT GROUND POTENTIAL.**

Thermal damage of various kinds can result if any of several critical temperatures are exceeded. Extremely high temperatures (above 425°C) will essentially cause new diffusions of the die, resulting in drastically changed electrical performance. Die attach temperatures establish a second critical temperature. Heating the package during soldering to above the die attach temperature (400°C for Si, 280°C for GaAs) can "float" the die, and seriously degrade the bond to the substrate. The third critical temperature is established by the maximum temperature the package can endure without damaging the integrity of the seal. Since there are a number of different types of seal (glass, epoxy, plastic, various solders) this temperature can vary from above 400°C to as low as 150°C. In general the temperature at which the seal degrades is the lowest critical temperature in the die - package system, and establishes the maximum temperature ratings of the device. Each critical temperature is time dependent, and has associated with it a certain "dwell time" above which damage will occur.

Because of the relatively small volumes usually encountered in the microwave industry, hand soldering has been by far the most popular way of attaching a device to a circuit. Avantek recommends the following guideline for this method: **HAND SOLDERING SHOULD PERFORMED AT 250°C, IN LESS THAN 2 SECONDS PER LEAD.** Hand soldering is the **ONLY** recommended method of soldering for any GaAs FET devices using low temperature solder seals.

Improved manufacturing technology and the advent of several consumer oriented microwave products has raised interest in more automated soldering techniques. These include wave soldering, vapor phase soldering, IR reflow soldering, and LASER reflow soldering, to name just a few. Rather than try to construct a recommended profile for each package type for each kind of soldering, Avantek provides the information

shown in Figures 1 through 3 to help the manufacturing engineer design a soldering profile. These curves show maximum recommended time versus temperature for the plastic (04, 05, 11, 84, 85, 86), micro-X ceramic (35, 36), and gold (10, 20, 23, 50, 70, 71) package families.

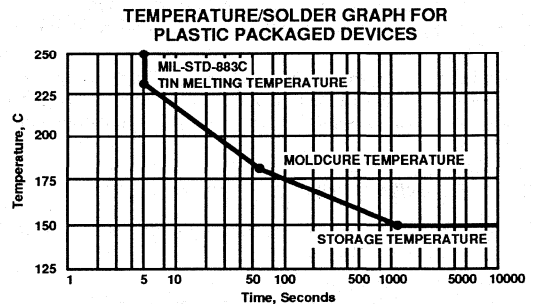

Figure 1

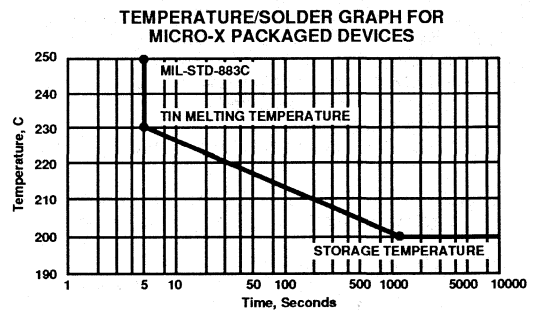

Figure 2

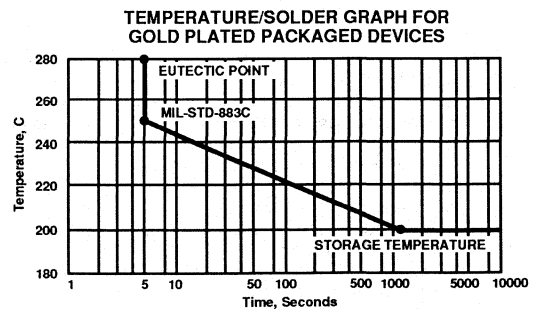

Figure 3

Electrical and Thermal Considerations

One extremely important electrical consideration should be kept in mind while mounting any microwave device. Any extra lead length becomes an additional, undesired circuit element at microwave frequencies. This is especially important for ground lead length; seemingly small lengths of lead can result in deciBells of lost gain. In general all leads should mount flush with the pc board, with the smallest gap possible left between package body and circuit traces. For packages where the leads are not co-planar with the bottom of the package, it is better to make a hole in the pc board to allow for flush mounting than to bend the devices' leads.

Thermal considerations involved in the mounting of small signal devices are minimal. The device lead attachment provides sufficient heatsinking to these semiconductors. The output lead is the primary heat path for bipolar transistors and MODAMP™ MMICs—for these devices the bottom of the die is the collector (output) meaning these devices tend to be die attached directly to the output trace. The ground leads are the primary heat path in GaAs FETs, since these devices have electrically isolated backsides and are therefore usually die attached directly to ground. Note that this means additional lead length not only degrades electrical performance, it also increases the operating temperature of a small signal device by increasing the case-to-ambient thermal resistance. 100 mils of lead length in free air can raise the case-to-ambient thermal resistance of a small signal microwave package to between 150°C/W to 300°C/W. In contrast, properly mounted small signal devices should have case-to-ambient thermal resistances of less than 50°C/W.

POWER DEVICE PACKAGES

Higher power devices come in specially designed packages that provide sufficient thermal conductivity to allow for reliable device operation at higher power dissipation levels. Packages for devices with bottom side electrical contacts (e.g. bipolar transistors) usually incorporate a Beryllium Oxide (BeO) ceramic substrate for superior thermal conductivity. Devices with electrically isolated backsides (e.g. GaAs FETs) do away with substrates under the die altogether, and mount directly to a rib of the heatsink brought up through the package for this purpose. Typically power packages are much larger than are the small signal packages, due to the need for heat spreading. Thus such packages often incorporate some additional mechanical means of mounting beyond lead attachment.

Electrical and Thermal Considerations

Electrical attachment of power packages is done in the same manner as for small signal packages: through soldering of the leads. The same hand soldering guideline of 2 seconds per lead at 250°C applies. The graph of time vs temperature for gold packages applies to the power packages as well. Mechanical and thermal attachment vary with the package style.

The 20 style package has an electrically isolated area of metallization on the bottom of the package. It is intended that this area be attached to the circuit heatsink, either by soldering, or using a good thermal conductive epoxy. Soldering should follow the time-temperature guidelines of the "gold" packages (see Figure 3). Although the soldering of the leads to the circuit board is sufficient for mechanical attachment of this package, this bottom connection is necessary for proper thermal operation.

Most other power devices come in packages with flanges that can be bolted directly to the circuit heatsink. For best thermal conductivity, the bottom of the flange should be coated with a THIN layer (10 mils or so) of thermal conductive grease. This will result in the lowest possible case-to-ambient thermal resistance (θ_{ca})—usually giving a value less than 5°C/W. Note that a thick layer of thermal grease is almost as bad a thermal conductor as an air gap and would result in much higher values for θ_{ca} . Additionally, many flange packages use the flange as the ground connection to the device (see individual data sheets for terminal configuration) and excessive grease could degrade this important electrical contact.

Mechanical Considerations

Improper mounting techniques can mechanically damage power device packages. Avantek suggests that the following methods be used when a power device is installed in a circuit.

When bolting a flange device into the circuit, it is important to tighten both bolts only until they are finger tight, then ALTERNATELY tighten until the flange is secured to the heat sink. Never tighten one bolt fully before inserting the second bolt; doing so can bow the package, resulting in miserable thermal contact or a cracked substrate.

It is also acceptable to solder the flange of a power device to the heatsink. The time vs temperature guidelines for "gold" packages should also be used when soldering power devices in gold metallized packages (see Figure 3).

Leads of power devices should be soldered to the circuit traces only after the body of the device has been mechanically attached to the circuit. When a semiconductor already soldered to a pc board is bolted to a heatsink, extreme vertical shear forces can result at the package lead braze, fracturing the braze joint where the lead meets the package.

Following the above guidelines will help insure that your circuits built with Avantek transistors and MMICs have the best possible longevity and reliability.

This is an abstract from Applications Note AN-A005: Transistor Chip Use.

PACKAGING, SHIPMENT AND STORAGE

Avantek chips are supplied in two inch trays that use an elastomer as a carrier medium. The chips are held in place by the surface tension of the elastomer. One corner of the tray is beveled to provide orientation for chip selection. Each chip tray is enclosed in a plastic box to protect the die during shipping. Up to 300 chips can be contained in a tray.

Chip carriers should be opened only at a clean, well-lighted station without fast moving air. A white working surface is recommended for best visibility. The chips are kept in place by the surface tension of the elastomer on which they are placed. Once the clamps have been removed, the pack should be set down on the surface and the lid removed. Then, the paper can slowly (to avoid static electricity generation) be lifted off the lower half. Occasionally a chip may work loose from the surface of the elastomer and turn upside down. If this happens, the chip should be carefully picked up with tweezers, turned over, and placed back on the elastomer. At this point the die can be counted or visually inspected. The reverse of the procedure outlined above should be used to close the die carrier pack prior to storage or die attach operations.

Die can be stored in the trays in which they are shipped. Die that will be stored for long periods of time (greater than 1 to 2 weeks) should be kept in a dry nitrogen atmosphere for optimum reliability. Avantek chips use a gold based metal system that is very resistant to deterioration; none the less, the best practice is to always store die in an inert atmosphere.

DIE HANDLING

Normal die handling is with tweezers to prevent contamination of the die attach surface. The brittleness of both silicon and GaAs makes the sharp edges of the chip susceptible to damage if too much pressure is applied. A good precaution is to use only very sharp tweezers with excellent point alignment when handling die (e.g. EREM type 5 SA). Inexperienced operators should practice with bonding samples, which can be obtained from Avantek.

The surface of the die is protected with a layer of silicon nitride passivation. This layer provides sufficient scratch protection to allow vacuum picks to also be used for moving die, as long as reasonable care is taken in die handling.

DIE ATTACH

The die attach process serves three functions. First, it mechanically attaches the die to the circuit substrate. Second, it electrically connects the output of the circuit to the trace on which the die is mounted. Third, it establishes the thermal path by which excess heat leaves the die. All three factors must be considered when selecting a die attach process.

Different procedures are used for silicon chips and GaAs devices. To attach a silicon chip, the chip and mounting surface are heated sufficiently for the gold of the mounting surface to mix with the gold backside metal on the chip and melt into the silicon of the chip, forming a gold-silicon eutectic bond. This technique is suitable because devices built on silicon can tolerate the relatively high temperatures needed for eutectic formation without electrical degradation. Eutectic die attach yields the best thermal transfer and lowest contact resistance of available die attach methods. The temperature sensitivity of

GaAs devices precludes the use of eutectic die attach; a low temperature gold alloy "solder-down" technique is used instead. In both cases the process should be carried out under an inert atmosphere blanket of forming gas or nitrogen to prevent die attach contamination.

Recommended Eutectic Die Attach Procedure

1. Set the heater block temperature to $410^{\circ}\text{C} \pm 10^{\circ}\text{C}$. This temperature should be measured at the point on the die attach stage where the package is to be heated; often there is a significant difference between the dial reading and the actual stage temperature.
2. Place the circuit or package into which the chip will be attached on the heater block. Allow sufficient time for it to heat thoroughly – typically 5 to 15 seconds depending on thermal mass.
3. Using tweezers or a vacuum collet, pick up the chip and orient it properly for placement on the mounting surface.
4. Place the chip directly on the mounting surface (in general preforms are not needed for eutectic die attach). Scrub with a back-and-forth motion, being careful not to scratch the top surface of the chip. Continue scrubbing until wetting occurs; this should occur within three to four scrubs.
5. If wetting does not occur, check that the heater block is at the correct temperature, that the inert atmosphere is present, and that all gold surfaces are free of contamination. The inert atmosphere should be heated to around 250°C to prevent it from cooling the die to below the gold-silicon eutectic forming temperature of 387°C .
6. When wetting occurs, perform one circular scrub to insure wetting of the chip perimeter. 100 flow should be visible around the die. Carefully remove the tweezers or collet from the die.
7. Remove the circuit or package from the heater block and allow it to cool in air. The total time for die attach should be less than 10 seconds. Maintaining the die at the 410°C die attach temperature for longer than this can lead to reduced device reliability.

Recommended "Solder-down" Die Attach Procedure

1. Set the heater block temperature to $300^{\circ}\text{C} \pm 10^{\circ}\text{C}$. This temperature should be measured at the point on the die attach stage where the package is to be heated; often there is a significant difference between the dial reading and the actual stage temperature.
2. Place the circuit or package into which the die will be attached on the heater block. Allow sufficient time for it to heat thoroughly – typically 5 to 15 seconds depending on thermal mass.
3. Pick up a gold-tin (Au-Sn) preform and place it on the circuit or package in the die attach location. Use a sufficient quantity to insure good wetting and to produce a fillet around the die.
4. Using tweezers or a vacuum collet, pick up the chip that is to be die attached and orient it properly for placement on the mounting surface.

Transistor Chip Use

5. Place the chip on the mounting surface and scrub with a back-and-forth motion, being careful not to scratch the top surface of the chip. Continue scrubbing until wetting occurs; this should occur within three to four scrubs. If wetting does not occur, check that the heater block is at the correct temperature, that the inert atmosphere is present, and that all gold surfaces are free of contamination.

6. When wetting occurs, perform one circular scrub to insure wetting of the chip perimeter. 100% flow should be visible around the die. Carefully remove the tweezers or collet from the die.

7. Remove the circuit or package from the heater block and allow it to cool in air. The total time for die attach should be less than 10 seconds. Maintaining the die at the 300°C die attach temperature for longer than this can lead to reduced device reliability.

WIRE BONDING

Electrical connections to the die are in general made by wire bonds. The output electrical connection to silicon products is most often made through the die attach, but can sometimes also be made through a topside wire bond (e.g. in the case of MODAMP™ chips). The bond pad size and metal adhesion strength of Avantek chips are compatible with either gold-ball bonding or wedge bonding. Either technique may be used when building chip assemblies.

Recommended Ball Bonding Procedure

1. If thermocompression ball bonding, set the heater block temperature to 300° ± 10° C for silicon product, or to 260° ± 10° C for GaAs product. If therosonic (ultrasonic) ball bonding set the heater block to 150° ± 10° C for either silicon or GaAs product.

2. Use prestressed (annealed) gold wire between .0007 to .001 inches in diameter.

3. Calibrate the bond force as follows:

Wire Diameter	Bond Force	MWB
.0007"	15 – 20 grams	20 ± 2
.001"	20 – 30 grams	25 ± 2

4. Proceed with bonding according to machine specifications. For common (emitter, source, or ground) wire bonds, start with the ball on the circuit bonding surface and bond to the common bond pad on the chip, then continue (stitch bond) to a second contact with the circuit bonding surface. Keep both loops of this common bond low and short.

Recommended Wedge Bonding Procedure

1. Set the heater block temperature to 300° ± 10° C for silicon product or to 260° ± 10° C for GaAs product. (Note: If the wedge is heated, the heater block temperature should be lowered slightly from this setting. The exact temperature setting will need to be determined empirically, and will vary from machine to machine.)

2. Use prestressed (annealed) gold wire between .0005 to .001 inches in diameter.

3. Tip bonding pressure should be between 15 and 20 grams, and should not exceed 20 grams. The footprint that the wedge leaves on the gold wire should be between 1.5 and 2.5 wire diameters across for a good bond.

4. Proceed with bonding according to machine specifications. Bonds should be made from the circuit element to the chip bonding pads to minimize pad damage. Also, bonds should be made to the source and drain pads of a FET prior to making the bond to the gate pad, to minimize the potential for electrostatic discharge damage.

This is an abstract from Applications Note AN-S009: MODAMP™ Silicon MMIC Chip Use.

DIE TOPOGRAPHY

MODAMP MMICs share a common topology, shown in Figure 1. Two bipolar transistors (Q1 and Q2) are connected in Darlington configuration. Shunt (R_F) and series (R_E) resistive feedback are used to set both the gain and the impedance match of the structure. Resistors connecting the bases of Q1 (R_B) and Q2 (R_{bias}) to ground complete the DC bias network. Some geometries have additional resistors (R_{C1} , R_{C2}) connected to the collector of Q2 to allow for optional on-chip biasing. Figure 2 identifies these components on a typical MODAMP chip outline drawing.

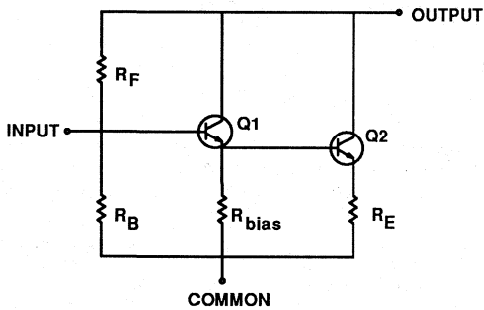
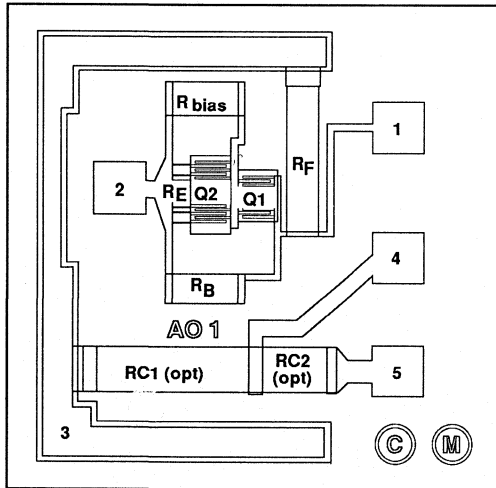

Figure 1. MODAMP Equivalent Circuit Schematic.



- 1- INPUT
- 2- COMMON
- 3- OPTIONAL OUTPUT
- 4- +12V ON-CHIP RC
- 5- +15V ON-CHIP RC

Figure 2. Typical MODAMP Chip Outline Labeling Components and Bond Pads. (MSA-0100 shown as an example)

The bond pad connected to the base of Q1 is the input to the circuit. The bond pad connected to R_E , R_B and R_{bias} is the amplifier's common (or ground) terminal. Electrically, the output of the circuit is the collector of Q2. Since the MMIC is built with conventional vertical bipolar technology, the entire bottom surface of the chip is a shared collector contact for the two transistors of the Darlington, and therefore serves as the output terminal of the MMIC. For convenience, a topside collector contact is also provided for designers who would rather wire bond the output connection to the chip. The remaining bond pads are bias options that are not normally connected in typical chip use.

USE OF OPTIONAL ON-CHIP BIAS RESISTORS

The most common way of biasing MODAMP MMICs is through a dropping resistor from a fixed voltage supply. The biasing resistor acts as a feedback element that stabilizes the DC operating point over temperature. The MSA-0100, MSA-0200, MSA-0300, MSA-0600, and MSA-0700 MODAMP geometries include optional on-chip resistors that can be used to bias the MMIC from a fixed voltage supply. For most designs, these on-chip resistors are left unconnected, and the bias is supplied through an external (off-chip) bias resistor. To make use of the on-chip bias option, wire bond the appropriate bond pad on the MMIC to a circuit trace that will supply the appropriate voltage. The bond pad nearest to the RF input bond pad is for use with a nominal +12 volt supply; the remaining bond pad is for use with a nominal +15 volt supply (see Figure 3).

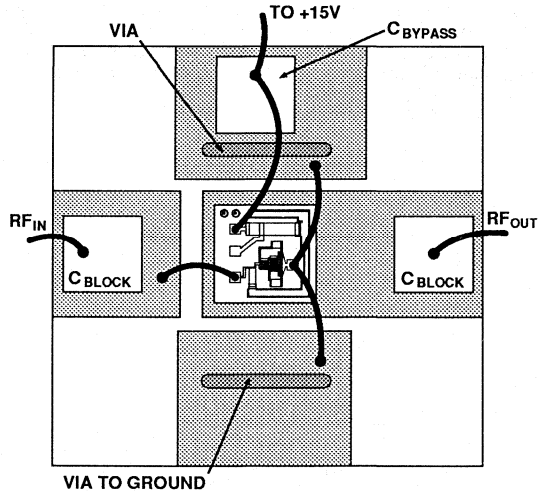

Figure 3. Representative Bond Scheme For Use Of On-chip Bias Resistor (+15V option)

The MSA-0600 and MSA-0700 geometries have 3 bond pad options: a +5 volt pad which is nearest to the RF input bond pad, a +12 volt pad, and a +15 volt pad which is furthest from the RF input pad. The length of the bond wire is not critical. A long wire is, if anything, preferable as the added series inductance it provides improves the effectiveness of the bias feed as an RF choke. The circuit will no longer require external bias resistors or chokes for biasing the MODAMP MMIC, although an external inductor in series with the bias resistor usually improves $P_{1\text{ dB}}$ and gain performance. A bypass capacitor at the power supply rail is still recommended.

MODAMP™ Silicon MMIC Chip Use

Several factors should be considered before using the on-chip bias resistors. First, the values of these resistors will vary from one wafer run to another; the nominal tolerance is ± 15 . Avantek does not guarantee either the values of these resistors or the performance that will be obtained if they are used. Next, these resistors are made of poly-silicon, which has a temperature coefficient of -0.0008 ppm/ $^{\circ}$ C. Since this coefficient is negative, the on-chip resistors provide less feedback at high temperatures (and hence less bias stability) than would an external carbon resistor possessing a positive temperature coefficient. Finally, using these resistors creates a significant new on-chip heat source that will raise the operating temperature of the transistors in the MODAMP MMIC. This will decrease some aspects of RF performance (especially P_{sat}) and reduce the MTTF of the MMIC.

SAMPLE CIRCUITS

Since MODAMP MMICs are matched 50Ω gain blocks, no special RF circuit design is required when using these chips. The MODAMP MMIC chip is die attached directly on the output trace, and the input connection is made by a wire bond. The ground connections are also made by wire bonds. Solid metallization should be brought up on either side of the die to allow for stitch bonding on the common bond. The bond attach points should be connected to the backside ground of the circuit through multiple vias.

Both input and output transmission lines need to be DC blocked; blocking capacitors should be of a high enough value to present a low series impedance across the frequency range over which the amplifier will operate. Remember to include the effect of parasitic inductance when calculating capacitor impedance. MOS capacitor die, ceramic chip capacitors, or gap capacitances in the transmission line traces can all be used as blocking capacitors.

MODAMP MMIC chips are DC biased in the same manner as packaged MODAMP products; refer to the next section on Biasing MODAMP MMICs or to Applications Note AN-S003: Biasing MODAMP™ MMICs for more information.

A sample layout for a one stage MODAMP MMIC amplifier is shown in Figure 4. This layout uses MOS chips for blocking

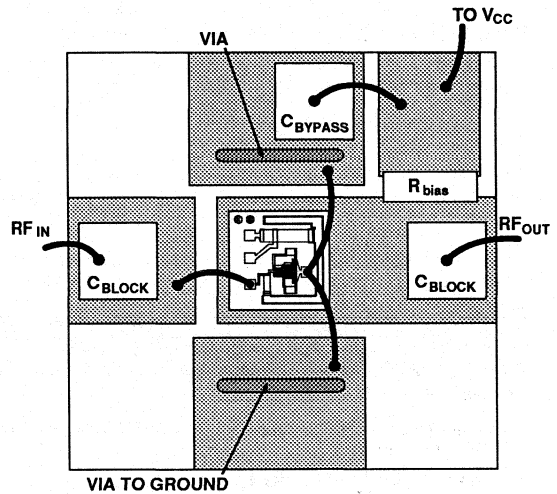

Figure 4. Typical One Stage MODAMP MMIC Circuit.

capacitors, ceramic chips for bypass capacitors, and thin film resistors for the bias feed. No additional choke inductance is used.

CONCLUSION

The simplicity and performance offered by MODAMP chips, combined with the reduced size and lower parasitics of chip-and-wire assembly technology, create microwave circuitry with superior performance.

*This is an abstract from Application Note AN-A003:
Biasing MODAMP™ MMICs.*

The bias point of the MODAMP™ MSA-Series MMIC can best be described by specifying the total device current I_D .

Both power and gain can be adjusted by varying I_D . Curves of typical performance as a function of bias are shown on the individual MODAMP MMIC data sheets.

BIAS CIRCUITRY OPTIONS

Once an appropriate bias point has been chosen, circuitry must be provided to ensure that the MODAMP MMIC operates at that bias point. To be effective, this circuitry must establish an appropriate bias point across the entire operating temperature range the MODAMP MMIC will experience. The internal resistors on the MMIC have a temperature coefficient of $-0.0008\%/^{\circ}\text{C}$; the on-chip transistors increase in β at a rate of $+0.07\%/^{\circ}\text{C}$. If the bias current I_D is to remain constant over a broad temperature range, the bias circuitry must decrease the device voltage V_D at higher temperatures and increase V_D at lower temperatures.

Three possible biasing schemes are described in detail below.

Voltage Source On Collector

The simplest bias scheme available is to provide a fixed voltage to the "collector" or output terminal of the MODAMP MMIC. This voltage can be supplied either from a voltage regulator or from a power supply. It must be provided through an RFC (Radio Frequency "Choke," or high-value inductor) to keep the high frequency signal isolated from the DC circuitry. A large-value capacitor (e.g., $1 \mu\text{F}$) should be connected from the DC side of the RFC to Ground to provide a low impedance path to any signal that does get past the RFC. DC blocking capacitors (or alternatively transformers, if the MSA is to be operated at very low frequencies or at DC) must be used to isolate both the input of the MSA from the drive source and the output of the MSA from the load. The entire circuit is shown in Figure 1.

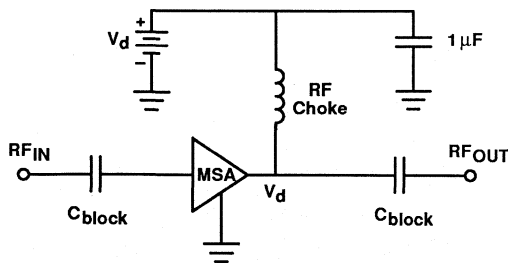

Figure 1. Fixed Collector Voltage Bias Circuit

Because of its very narrow temperature operating range and sensitivity to V_D this bias scheme is not appropriate for most production circuits. It finds its major applications in laboratory testing of devices utilizing variable power supplies to provide the bias. With this bias scheme, temperature variations on the

order of 25°C will cause significant alterations in performance; temperature variations on the order of 75°C can destroy devices by causing them to draw too much current. Device-to-device variations may also yield a MODAMP MMIC that draws an excessively high current if V_D is fixed, even at room temperature.

Collector Bias Stabilization Resistor

The fixed collector voltage bias circuit described above can be changed into a temperature-compensated bias circuit with the addition of a bias stabilization resistor in the collector feed. This resistor acts as a simple feedback element. As the temperature increases, the MODAMP MMIC tries to draw more and more current. Since this current is supplied through a resistor, the MODAMP MMIC bias voltage V_D decreases as I_D tries to increase: V_{CC} stays fixed; I_D increases with temperature causing the voltage drop $I_D R_C$ across R_C to increase, thus lowering V_D and "throttling back" on the bias current I_D . Note that the amount of feedback is proportional to the voltage drop across R_C , and hence to the value of R_C . For effective compensation over normal operating temperature ranges (-25°C to $+100^{\circ}\text{C}$), a voltage drop of at least 4 volts is recommended.

Remember that R_C itself will change in resistance as the temperature changes. By selecting a bias resistor with an appropriate temperature coefficient the temperature compensation of this circuit can be "fine tuned." Carbon composite resistors typically have a temperature coefficient of $+0.001\%/^{\circ}\text{C}$, and work particularly well as bias stabilization resistors.

A side benefit of using a bias stabilization resistor is that it is often of high enough impedance that an RFC is no longer needed to keep the high frequency signal out of the DC bias. It is recommended that an RFC still be used if the MODAMP MMIC is being used near saturation; otherwise R_C appears in parallel with the load resistance and can cause enough of a shift in load impedance to reduce both gain and saturated power by 1 to 2 dB.

The circuitry needed for a bias stabilization resistor scheme is shown in Figure 2.

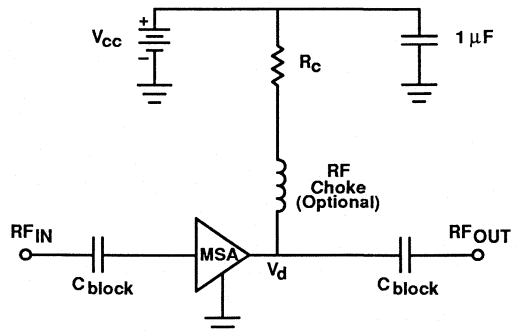

$$R_c = \frac{V_{cc} - V_d}{I_D}$$

Figure 2. Collector Bias Stabilization Resistor Bias Circuit

Biasing MODAMP™ MMICs

Active Bias

Active bias circuitry can be used to provide temperature stability without requiring the large voltage drop or relatively high dissipated power needed with a bias stabilization resistor. A simple realization using a resistively-biased PNP transistor as a current source is shown in Figure 3.

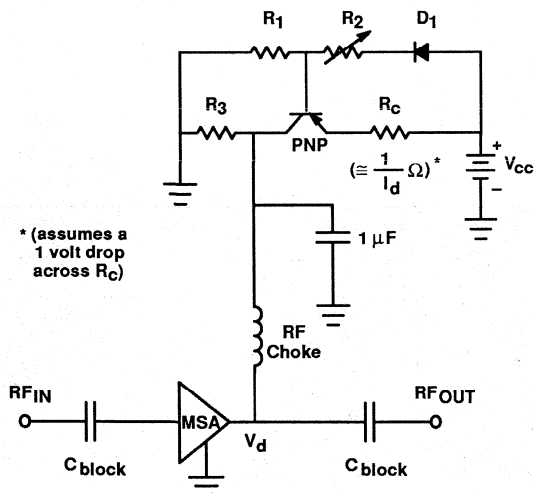

Figure 3. Active Bias

In this circuit R_1 and R_2 form a resistive divider that establishes the bias point of the PNP bias transistor. R_3 provides a "bleed path" for any excess bias current; it is a safety feature that can be omitted from minimum element realizations of this circuit. D_1 is also an optional element; its purpose is to provide temperature compensation by tracking the voltage variation with temperature of the emitter-to-base junction of the PNP bias transistor. For this reason, when it is included it is often realized using the E-B junction of a second PNP transistor identical to the bias transistor, connected with its collector-base junction shorted.

R_C is a feedback element that keeps I_d constant. If the device current starts to increase, the voltage drop across R_C also increases, turning off the E-B junction of the PNP transistor, and hence decreasing the bias voltage V_d applied to the MSA. For best circuit operation, there should be at least a .5 to 1 volt drop across R_C . The PNP transistor is acting in the saturated mode with both junctions forward biased. The voltage drop needed across the emitter to collector junction of this transistor will therefore be equal to its V_{CEsat} —typically only several tenths of a volt. Thus, the total voltage difference needed between V_{CC} and V_d is only about 1.3 volts for this circuit, as compared to the 4 volts or so needed by the bias stabilization resistor for good bias stability over temperature.

A side effect of the PNP bias transistor operating in the saturated mode is that this bias requires some extra "charge up" time at turn-on and "discharge" time at turn-off. How much extra time is required will depend on the time constants of the PNP transistor.

Systems requiring wide dynamic range operation or AGC (automatic gain control) often require that the MSAs operate at variable operating points. If R_2 is made variable this bias scheme will work well for such applications.

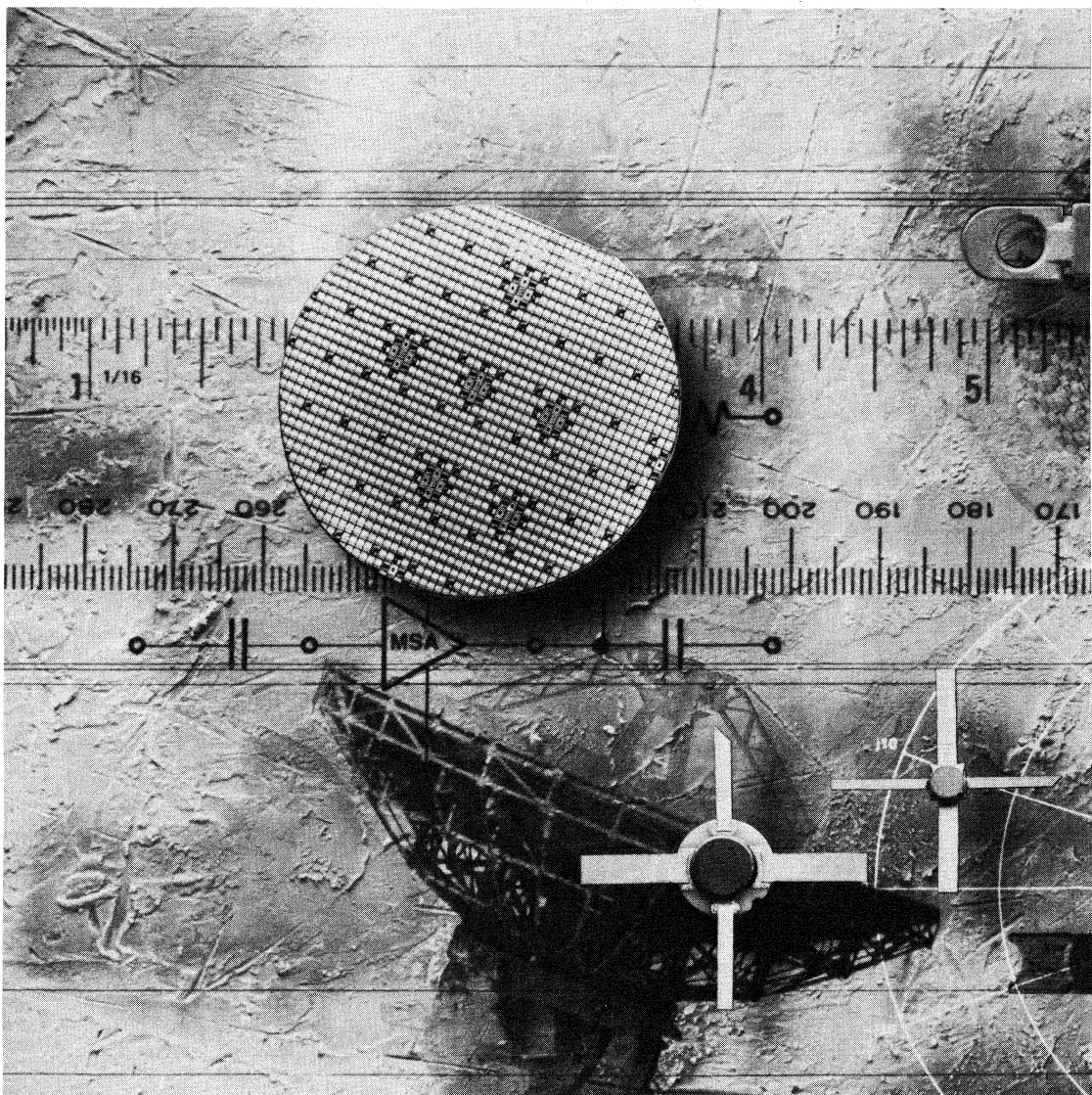

Measurements

S-PARAMETERS	7-2
NOISE PARAMETERS	7-3
POWER PARAMETERS	7-6
THERMAL RESISTANCE	7-6

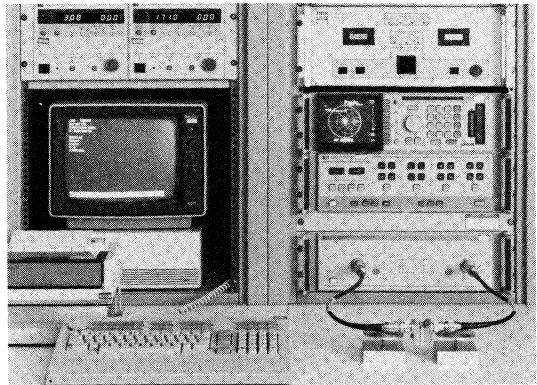
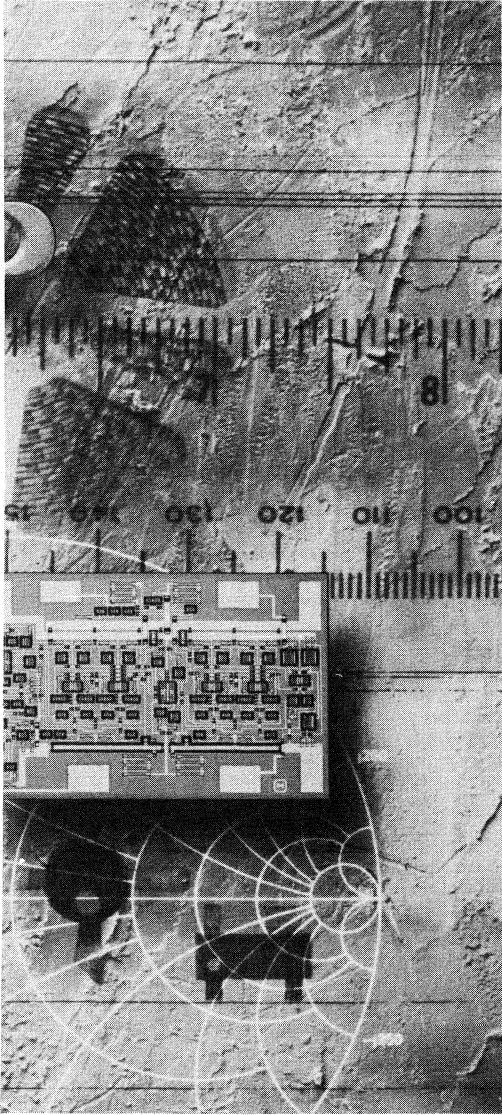

The data on the devices presented in this catalog were taken by measurements performed in 50 ohm test fixtures which may be procured from Inter-Continental Microwave of Santa Clara, CA.¹ These measurements may be divided into four basic groups: S-parameters, noise parameters, power parameters and thermal parameters. Except for power parameters, these subjects are covered in detail in the Avantek Transistor Primer Series. The following are brief summaries of the topics.

S-PARAMETERS

Scattering parameters are a group of measurements taken at different frequencies which represent the forward and reverse gain, and the input and output reflection coefficients of a microwave component when the input and output ports of the component are terminated in equal impedances – usually 50 ohms. Some pertinent definitions are as follows:

Magnitude	The length of the vector in the polar plane.
Angle	The direction of the vector in the polar plane.
dB	$10 \log_{10}$ (Power Magnitude) or $20 \log_{10}$ (Voltage Magnitude)
S ₁₁	S-parameter input reflection coefficient – Expresses the magnitude and phase of the input reflection coefficient with the input and output ports terminated in a pure resistance of 50 ohms.
S ₂₁	S-parameter forward transfer coefficient – Expresses the forward voltage gain magnitude and phase measured with the input and output ports terminated in a pure resistance of 50 ohms.
S ₁₂	S-parameter reverse transfer coefficient – Expresses the reverse voltage gain (sometimes called isolation) magnitude and phase, measured with the input and output ports terminated in a pure resistance of 50 ohms.
S ₂₂	S-parameter output reflection coefficient – Expresses the magnitude and phase of the output reflection coefficient with the input and output ports terminated in a pure resistance of 50 ohms.

k Stability factor, given by

$$k = \frac{1 + |D|^2 - |S_{11}|^2 - |S_{22}|^2}{2|S_{21}||S_{12}|}$$

where $D = S_{11}S_{22} - S_{21}S_{12}$

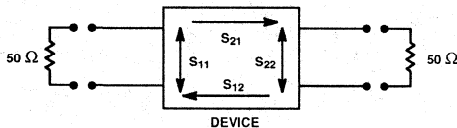

Figure 1. Two Port S-Parameters

If $k > 1$ and $|D| < 1$ then the two port that k describes is unconditionally stable for all terminations with non-negative resistance. If $k < 1$ some terminations exist which will cause the two-port to oscillate.

The utility of S-parameters as a complete description of a device's small signal (linear) performance has been generally accepted by the microwave industry. S-parameters are preferred over other 2-port parameters (Z, Y, H, etc.) as a means of characterization because they are easier to measure: the terminations required usually result in stable device operation, and commercial equipment designed specifically for S-parameter measurement is readily available. None the less, accurate S-parameter device characterization is difficult to obtain for a number of reasons.

Since a device's performance characteristics are a function of both its bias point and its operating temperature, it follows that the S-parameter description used to describe the device's behavior should also vary with bias point and temperature. For this reason, both the bias and the temperature need to be specified. In general, Avantek provides S-parameters measured at the recommended operating bias and at +25°C ambient temperature. In cases where operation at different bias levels might be appropriate, more than one description is generally given.

For a number of reasons, S-parameters will vary from device to device. The major reasons are process variations, material inconsistencies and assembly irregularities. A normal distribution of S-parameters is approximately $\pm 10\%$. Avantek publishes data which is a measurement of a "typical" unit. This unit is chosen from coarse screening of at least six wafers and approximately 100 parts. Then a fine screening is performed and the number of parts is cut to approximately 20. Finally, the device which is deemed the most "typical" is chosen.

The actual measurement of the device is made in a test fixture using an HP8510 Network Analyzer.² The style of the fixture will greatly influence the measurement. To achieve the best results, the device should be measured in the medium in which it will be used. Since the majority of Avantek's customers design in microstrip, this is the style of fixture that is currently being used to characterize the devices.³ Such a fixture is shown in Figure 2 where the device is mounted between two 50 ohm microstrip substrates which are sandwiched between two 50 ohm connector assemblies. Note that this fixture features excellent grounding and may have a shorter ground path than does a production circuit. The designer may wish to add some common lead inductance to the published S-parameters to compensate for this effect.

If the S-parameters that are published are to be repeated, the conditions under which they are taken must be duplicated as closely as possible. Measurements should be taken on the Inter-continental Microwave fixture (from the 1000 series or 2000 series) that Avantek is currently using and measurements should be made on a HP8510 Network Analyzer. The device should be biased at the same bias as specified in the catalog, and the same method of correcting for the effects of the test fixture must be applied.

1. Inter-Continental Microwave, 23708 Walsh Ave., Santa Clara, CA 95051

2. Hewlett-Packard Corp., 1501 Page Mill Road, Palo Alto, CA 94304

3. In previous Avantek catalogs, devices had been characterized in a 50 ohm coaxial fixture which is also available from Inter-Continental Microwave.

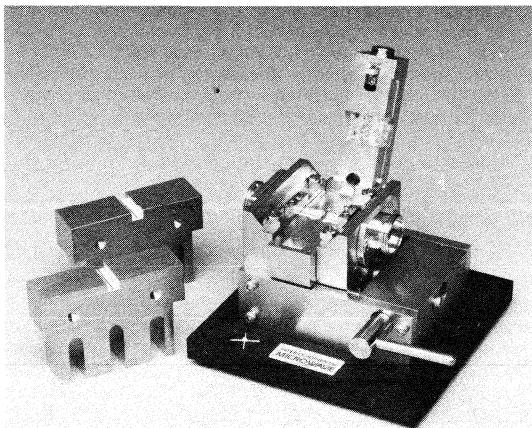

Figure 2. Typical 50 Ohm Test Fixture

The simplest method for correcting is the reference plane extension (rpe) technique. Avantek uses this method to characterize its silicon products up to 6 GHz. This method assumes a lossless, reflectionless, dispersionless fixture with the input and output having identical properties. The measured S-parameters are simply corrected mathematically by the software to account for the electrical length of the fixture. This electrical length can be determined by either measuring the distance to an open circuit or 1/2 the distance of a "through" line.

A more accurate method of correction is to de-embed the data. This is accomplished by characterizing the fixture and then subtracting its effects from the measured S-parameters. Though generally more time consuming than the reference plane extension methods, this technique must be used to obtain accurate S-parameters above 8 GHz.

Avantek uses the "through-delay" method of de-embedding S-parameters for GaAs devices. The "through" is a 50 ohm microstrip transmission line with an electrical length equal to the sum of the input and output substrates used in the fixture. The "delay" is a transmission line similar to the through with a 50 mil longer physical length. Since this technique compares electrical lengths, it is inaccurate at frequencies where the through and the delay are essentially the same length (below 1 GHz). For further explanation of this technique refer to the Avantek Application Note *Measurement and Modeling of GaAs FET Chips*.

Since the unpackaged die are mounted on chip carriers (see Figure 3) in order to measure their S-parameters, it is impossible to 100% test this kind of device before shipping. Instead, S-parameters are measured on a sample of devices at the wafer qualification step. The chip S-parameters that Avantek lists in this catalog are based on chip carrier measurements, and include the inductances associated with the bond wires (about 0.5 nH gate and drain bond and 0.15 nH source bond for a FET and about 0.5 nH base bond and 0.2 nH emitter bond for a bipolar device).

NOISE PARAMETERS

The noise performance of a transistor can be described by four noise-parameters in the noise figure equation:

$$F = F_{\text{MIN}} + \frac{R_N}{G_G} \left| Y_G - Y_{\text{OPT}} \right|^2$$

where:

F_{MIN} is the minimum transistor noise figure

R_N is the noise resistance in ohms

$Y_{\text{OPT}} = G_{\text{OPT}} + jB_{\text{OPT}}$ is the required generator admittance at the input port for minimum noise figure

$Y_{\text{GP}} = G_{\text{GP}} + jB_{\text{GP}}$ is the generator admittance at the input port.

$\Gamma_{\text{OPT}} = \frac{Y_O - Y_{\text{OPT}}}{Y_O + Y_{\text{OPT}}}$ is the generator reflection coefficient corresponding to Y_{OPT}

These parameters are measured in a 50 ohm system with a low loss tuner at the input and output ports. The transistor is biased for minimum noise, the output tuner set for maximum gain and the input tuner set for minimum noise figure. The measurement of F_{MIN} must include a correction for the tuner loss, as well as for second stage noise correction.⁴ The input tuner is later measured for the G_{OPT} noise parameter, which is referred to the transistor input reference plane by translating the reflection coefficient by an equivalent circuit model of the test fixture.

The parameter R_N is determined by measuring the 50 ohm noise figure:

$$F_{50} = F_{\text{MIN}} + 50R_N \left| .02 - Y_{\text{OPT}} \right|^2$$

$$R_N = \frac{F_{50} - F_{\text{MIN}}}{50 \left| .02 - Y_{\text{OPT}} \right|^2}$$

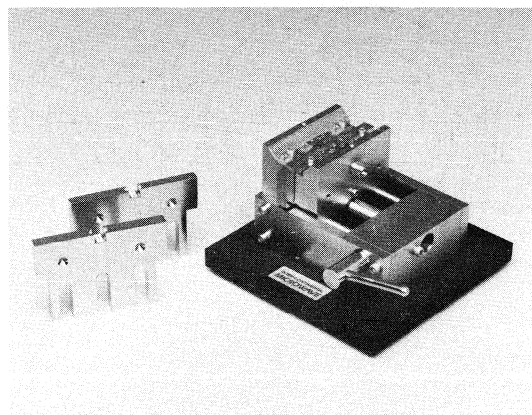

Figure 3. Test Carrier Used to Characterize Unpackaged GaAs FET Chips

4. Eric W. Strid, "Measurement of Losses in Noise-Matching Networks" *IEEE Transactions on MTT*, Vol. MTT-29, March 1981, pp 247-252.

Measurements

This data is further verified by measuring F at several other tuner settings which are later measured for Γ_G or Y_G . As an additional check on the noise data, an internal device modeling program (AMCAP) is used to generate the theoretical noise parameters from the small-signal equivalent circuit. This simulation can also be used to generate noise parameters at other frequencies.

By plotting the noise figure circles and available gain circles in the Γ_G plane, the accuracy of both S-parameter and noise-parameter data can be verified. Figures 4 and 5 show these circles for 4 Avantek low noise devices, AT-41435, AT-60535, ATF-10136 and ATF-13136 at appropriate frequencies when biased for best noise figure in a 50 ohm system.

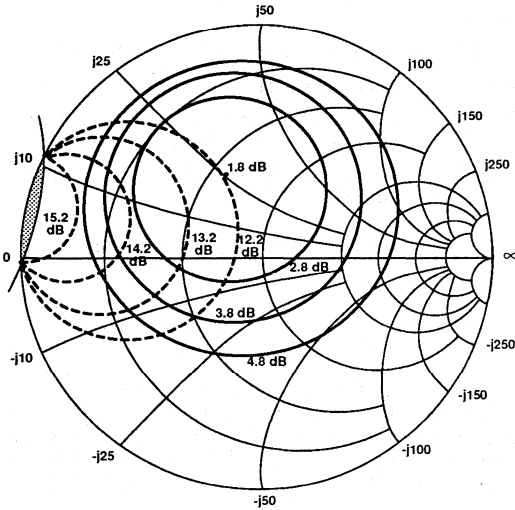

AT-60535: $f = 2 \text{ GHz}$, $V_{CE} = 8 \text{ V}$, $I_C = 2 \text{ mA}$

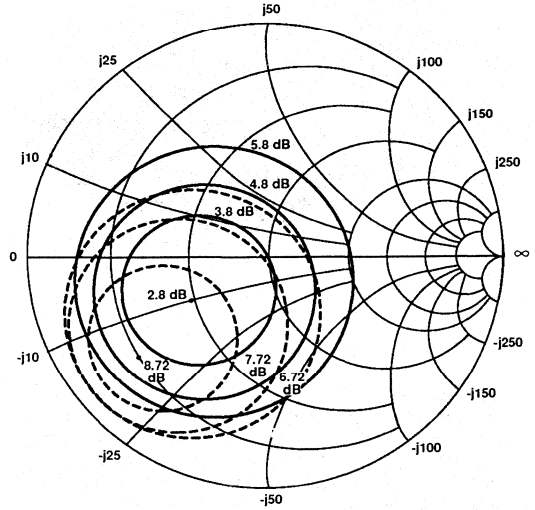

AT-60535: $f = 4 \text{ GHz}$, $V_{CE} = 8 \text{ V}$, $I_C = 2 \text{ mA}$

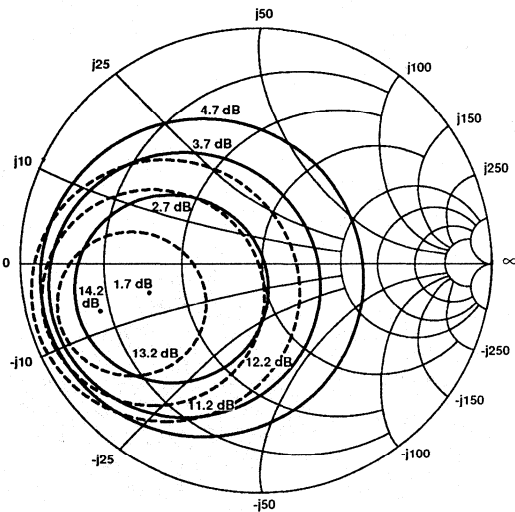

AT-41435: $f = 2 \text{ GHz}$, $V_{CE} = 8 \text{ V}$, $I_C = 10 \text{ mA}$

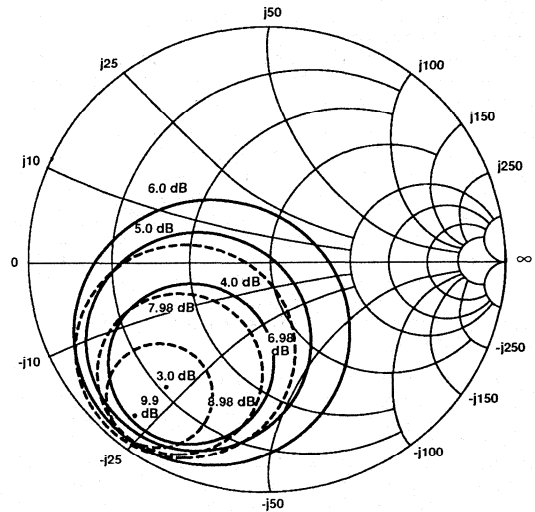

AT-41435: $f = 4 \text{ GHz}$, $V_{CE} = 8 \text{ V}$, $I_C = 10 \text{ mA}$

KEY: ———— Noise Circles; - - - - - Gain Circles

Figure 4. Noise Figure Circles and Available Gain Circles in the Γ_G Plane

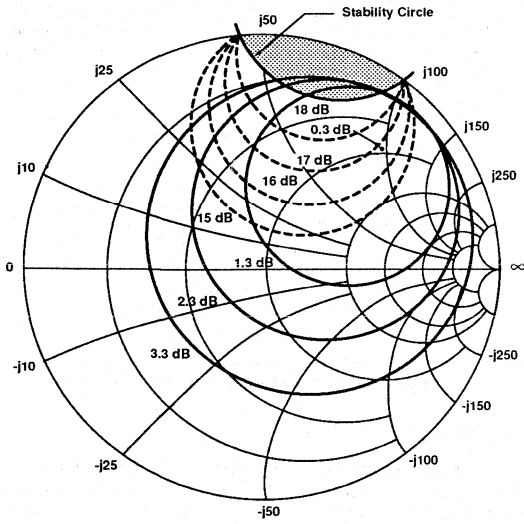

ATF-10136: $f = 2 \text{ GHz}$, $V_{DS} = 2 \text{ V}$, $I_{DS} = 20 \text{ mA}$

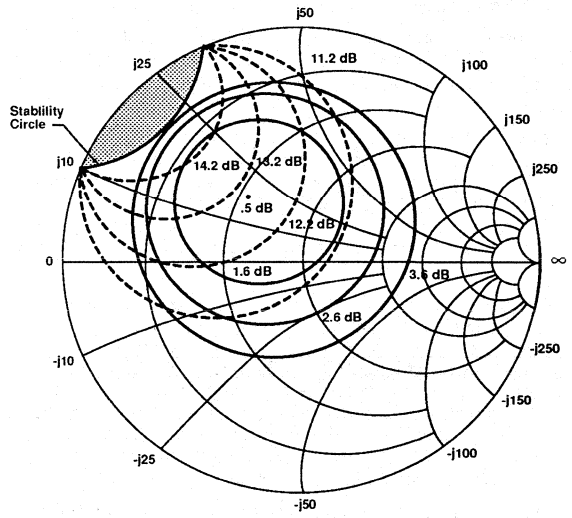

ATF-10136: $f = 4 \text{ GHz}$, $V_{DS} = 2 \text{ V}$, $I_{DS} = 20 \text{ mA}$

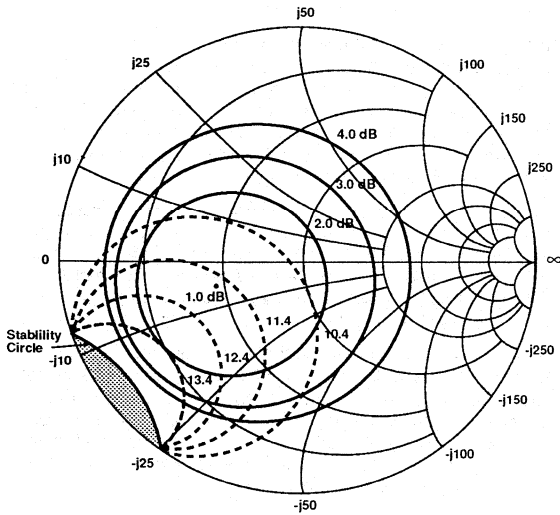

ATF-13136: $f = 8 \text{ GHz}$, $V_{DS} = 3 \text{ V}$, $I_{DS} = 20 \text{ mA}$

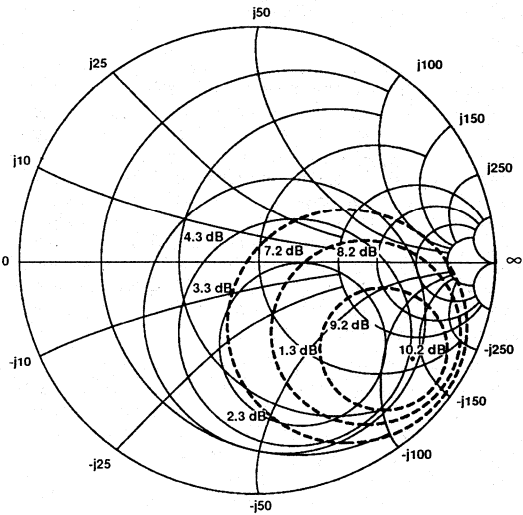

ATF-13136: $f = 12 \text{ GHz}$, $V_{DS} = 3 \text{ V}$, $I_{DS} = 20 \text{ mA}$

KEY: ———— Noise Circles; - - - - - Gain Circles

Figure 5. Noise Figure Circles and Available Gain Circles in the Γ_G Plane

Measurements

POWER PARAMETERS

The power characteristics of devices in this catalog consist primarily of two parameters: $P_{1\text{ dB}}$ and $G_{1\text{ dB}}$. $P_{1\text{ dB}}$ is the device output power at one dB gain compression. $G_{1\text{ dB}}$ is the one dB compressed gain.

Power measurements were made using Class A bias points. This kind of operation gives best linearity, and is typical of device use. In general, $P_{1\text{ dB}}$ can be improved by increasing bias current, though tradeoffs with MTTF, noise figure, IP_3 , or other parameters may be involved. Improved efficiency can be obtained with the discrete devices by operating them Class C.

All silicon product power measurements were made in 50 Ω coaxial test fixtures. Bias was provided through HP bias tees. Separate collector and base supplies were used to bias the discrete devices; MODAMP MMICs were biased from a power supply through an appropriate dropping resistor: in all cases the bias point was set to the catalog value of I_C or I_D under DC (no signal) conditions, and not subsequently adjusted during measurements. Note that some amount of current pulling can occur at $P_{1\text{ dB}}$ using these bias schemes.

Power measurements for small signal and unmatched power GaAs FETs and GaAs MMICs were made in 50 ohm coaxial test fixtures. Bias was provided through HP bias tees. Each device was biased to the catalog value of V_{DS} and I_D under DC (no signal) conditions. Small signal devices were tested using separate drain and gate supplies with a common ground point and active feedback via an operational amplifier to prevent current pulling. Discrete power devices used separate supplies with no feedback, allowing some amount of current pulling at $P_{1\text{ dB}}$.

Tuners were used to present the correct large signal impedances to discrete and unmatched GaAs MMIC devices to obtain $P_{1\text{ dB}}$ and $G_{1\text{ dB}}$. Both tuners were adjusted to obtain maximum output power with the device set at the catalog nominal value ($P_{1\text{ dB}} - G_{1\text{ dB}}$). The input drive level was then decreased by 10 dB, and the nominal small signal gain was measured. (Measurements for Silicon MODAMP MMICs did not use tuners; as these devices are already matched for operation in a 50 ohm system.) The input drive level was then increased until the measured gain had decreased by one dB from the nominal small-signal value. This gain value was recorded as $G_{1\text{ dB}}$. The power level at which this gain was measured was recorded as $P_{1\text{ dB}}$.

For best power performance, discrete devices must be matched to the appropriate large signal impedances Γ_{GP} (at the input) and Γ_{LP} (at the load). These impedances are frequency, bias, and power level dependent. They are best obtained by direct measurement of the tuners used in the $P_{1\text{ dB}}$ setup described above, translating the measured tuner impedance back to the reference plane of the device. For bipolar devices, if measured large signal impedances are not available Γ_{GP} and Γ_{LP} may be estimated as follows.

Γ_{GP} is approximately equal to S_{11}^* . Γ_{LP} can be obtained from the simple output model shown in Figure 6. This figure shows an equivalent circuit for the output of the transistor; this impedance should be matched to the system impedance (usually 50 Ω). For this model R is given by $(.9V_{CE})^2/(8P_{OUT})$ for Class A operation, where V_{CE} is the device collector to emitter voltage and P_{OUT} is the desired output power. C is approximately

$1.5 C_{CB}$ (C_{CB} measured at $V_C/2$ is a slightly better determination). L depends on package style, and is about 1 nH for microstripline packages and about 1.5 nH for larger power packages.⁵

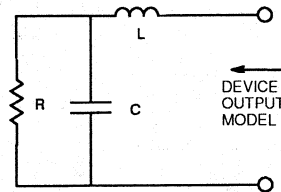

Figure 6. Large-Signal Load Model

THERMAL RESISTANCE

Although a simple concept, the thermal resistance of a device is a complicated parameter that can be defined in several ways. It will vary with the operating temperature of the device being measured, the way in which the junction and case temperatures are specified, the bias point at which the device is operating, the presence or absence of an AC input signal to the device, and the environment.

Avantek uses the following simple formula to define thermal resistance θ_{jc} :

$$\theta_{jc} = [T_J - T_C] / P_T$$

In this equation, T_J is the hottest junction or channel temperature on the device being measured. T_C is the case temperature if the device is a packaged component, or the temperature of the surface on which the device is mounted for an unpackaged die. P_T is the total power dissipated in the device, and is equal to the DC and RF power into the device minus the RF power out of the device.

There is also a thermal resistance θ_{ca} that characterizes the heat transfer between the case of the device and the ambient environment. Since this number depends at least as heavily on how the device is mounted, the surface (heatsink) it is mounted on, air flow and near-by heat sources as it does on the device itself, values for θ_{ca} are not included in this catalog.

A variety of measurement techniques exist for determining values for θ_{jc} . Avantek's preferred method is the liquid crystal technique⁶, as it has the required 1 to 2 μm resolution needed for measuring the small device structures found in microwave devices. Although not used for any product in this catalog, infrared (IR) methods can be used in applications that do not require resolution below about 15 μm .

5. William Mueller, "Linear Amplifier Design - some General Considerations," *RF Design*, March 1980, pp 37-41.

6. K J Negus, R W Franklin, M M Yovanovich, "Thermal Modeling and Experimental Techniques for Microwave Bipolar Devices", IEEE Semiconductor Thermal and Temperature Measurement Symposium, Feb. 7-9, 1989, pp. 63-72.

Several electrical methods also exist that rely on the measurement of a thermally sensitive parameter such as ΔV_{BE} or ΔV_{GS} , but have the drawback of providing an average as opposed to maximum junction temperature. AvanteK uses an electrical method⁷ to determine the thermal resistance of plastic encapsulated transistors, which cannot be measured with methods requiring visual inspection of the die. The thermal resistance of plastic encapsulated MMICs is arrived at by combining separate determinations of die thermal resistance and package heat transfer characteristics.

In the liquid crystal method, the package lid is removed and the die surface is coated with a nematic liquid crystal layer. The active junction area is observed through a microscope having crossed linear polarizers in the incident and reflected light paths. Because of the change in optical properties at its melting point T_{NI} (nematic to isotropic transition), the liquid crystal regions of the die that are above and below the melting point can be visually identified. The device is biased and heated until the specified area exceeds the transition temperature and the thermal resistance is calculated from the measured T_{NI} , T_C , and P_T . Gallium Arsenide products are measured at a channel temperature of 150°C. Silicon products are measured at a junction temperature of +100°C. The θ_{JC} values in this data book for silicon products are specified at a case temperature of +25°C; a mathematical conversion is

performed using a model⁸ based on the temperature dependent thermal resistance of the silicon die.

The case temperature T_C is determined by direct measurement with a small thermocouple. For devices in small signal packages with straight leads, the thermocouple is mounted as near as possible to the body of the case on the lead with the highest thermal conductivity path to the die. For plastic surface mount packages with gull wing leads, the thermocouple is mounted to the bottom of the lead. This is the collector lead for silicon bipolar transistors, the output lead for MSA-series silicon MMICs and the ground lead for all other silicon MMICs and GaAs devices.

For hermetic surface mount packages with gull wing leads, the thermocouple is mounted to the bottom of the package. In power packages, the thermocouple is mounted on the flange (230 mil flange package) or on the bottom (200 mil BeO package) of the BeO disc. To determine the thermal resistance of an unpackaged die, the device is either mounted in a package with excellent thermal transfer properties (e.g. the 230 mil flange package), or on a ceramic die carrier.

For additional information on thermal resistance theory and measurements, contact AvanteK for available applications notes.^{9,10}

7. *ibid.* pg 65.

8. *ibid.* pg 67.

9. AvanteK Transistor Primer III (Thermal Properties), publication ATP-1040.

10. AvanteK Transistor Primer III-A (Thermal Resistance), publication ATP-1072.

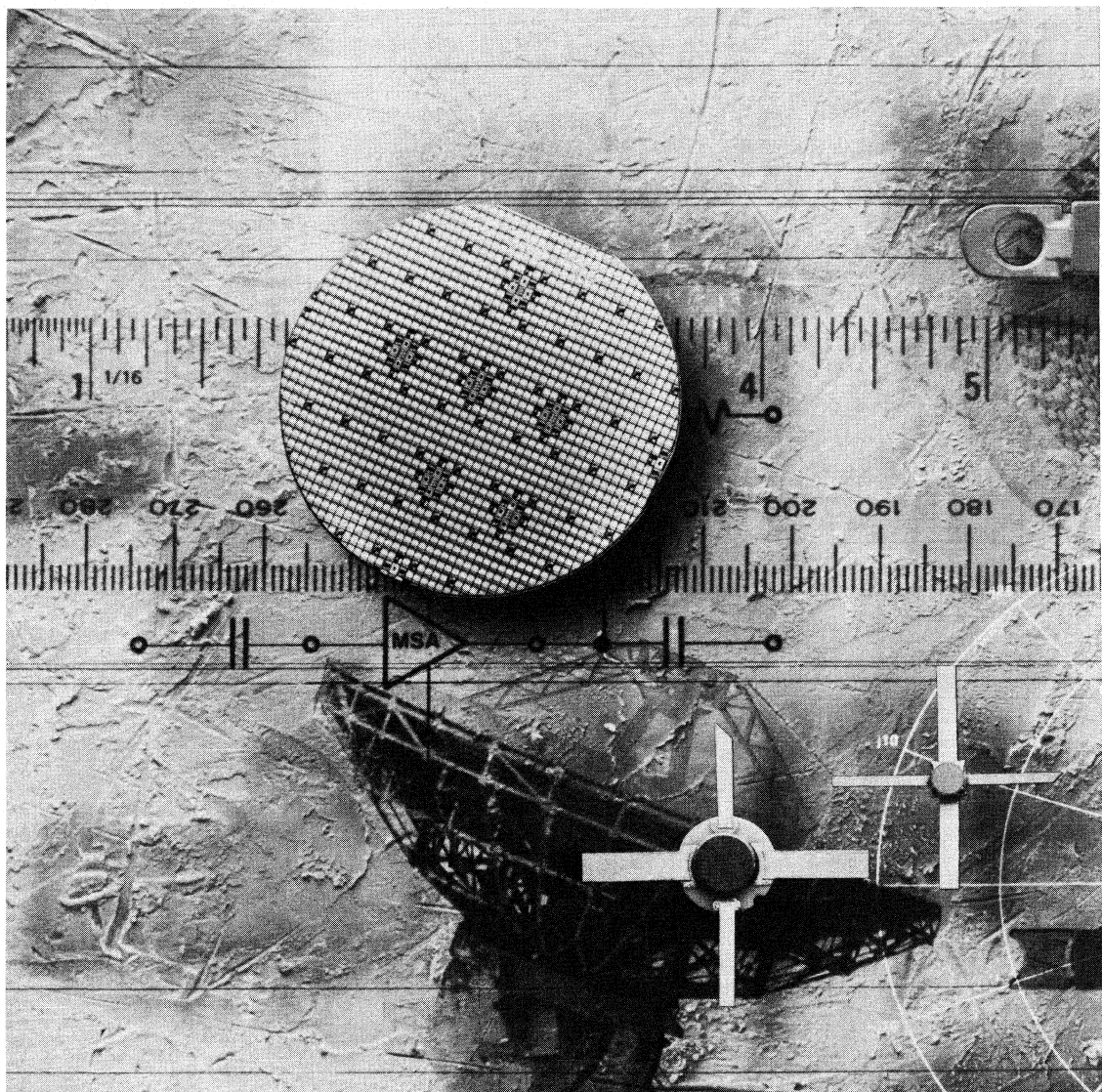

Device Modeling

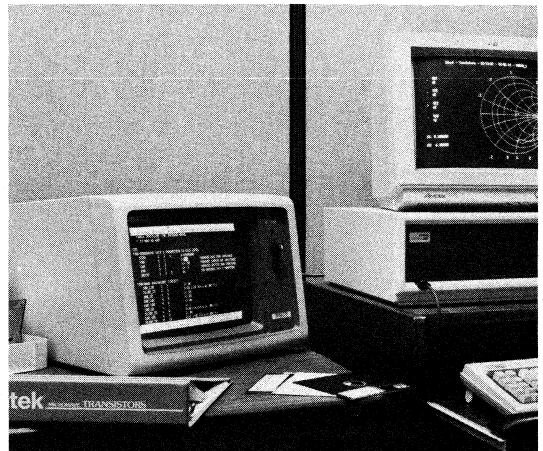
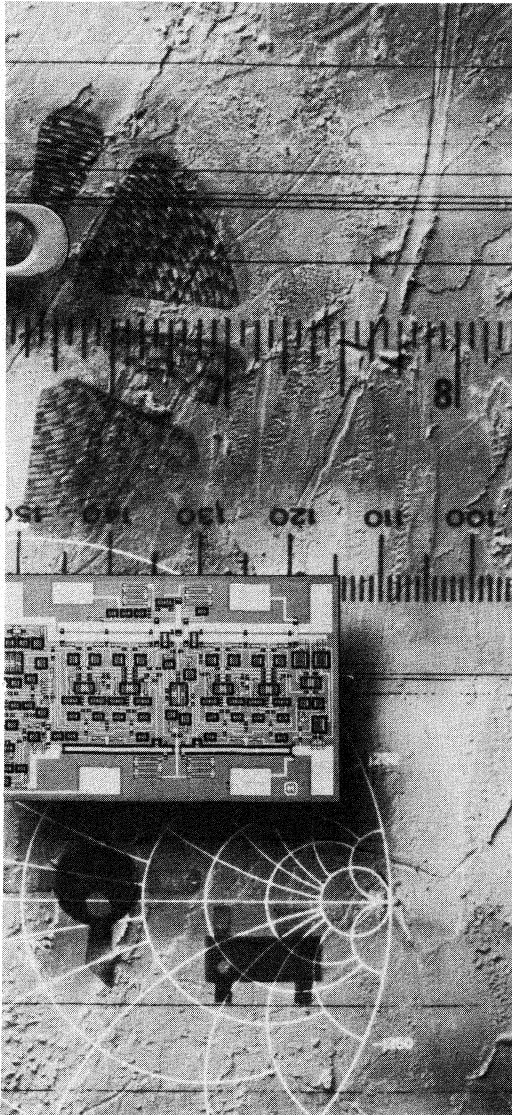

Avantek makes use of computer models to design high frequency transistors and to predict their performance in various applications. Both linear and non-linear models are used. Linear models apply at one specific set of (non-changing) bias and temperature conditions, and simulate small signal performance in the frequency domain. Non-linear models add the capability of predicting performance changes as a function of temperature or bias, and also allow for analysis of transient behavior. These models work in the time domain, and require much more data and computational time than do linear models.

BIPOLAR MODELS

Both linear and non-linear models are available for Avantek's bipolar based products. The two kinds of models have the same basic form. Each starts with the intrinsic transistor function. The non-linear model is a SPICE simulation, and uses that program's intrinsic transistor model (Q in the accompanying schematics). The linear model uses a current controlled current source α , the intrinsic emitter resistance R_i , and the intrinsic emitter capacitance C . The current generator α is described by the equation $\alpha = [\alpha_0 \exp(-j2\pi f T_C)] / [1 + j f / f_b]$. α_0 is given by $(\beta - 1) / \beta$ where β is the DC current gain of the transistor;

for Avantek's bipolar process a typical value for α is .99 (corresponding to a DC β of 100). The frequency roll-off of the current generator can be calculated from the base transit time; for this process this number is 7 psec, corresponding to a corner frequency f_b of 22.7 GHz. The time delay associated with the current generator (T_C) comes from the collector delay, and is a function of bias; values for T_C are included in the tables that follow. The intrinsic emitter resistance can be calculated from the bias as $R_i = 26 / (I_C \text{ in mA})$. The intrinsic emitter capacitance is proportional to area, and can be approximated by multiplying the SPICE # for Q in the tables that follow by .005 pF.

A transmission line structure of resistors (R_{B1} , R_{B2} , R_{B3}) and capacitors (C_{D1} , C_{D2} , C_{D3}) is added to the basic transistor to simulate the significant electrical length of the base region at microwave frequencies. By using a diode model (similar to a varactor model) rather than a fixed capacitor in this "distributed base" description, the non-linear model obtains the capability of simulating the variation in base capacitance as a function of bias voltage. Both models then add collector and emitter contact resistances (R_C and R_E). Both versions of the power device model have an additional emitter ballast resistor (R_{bal}), and a dynamic output capacitance (C_{D4}).

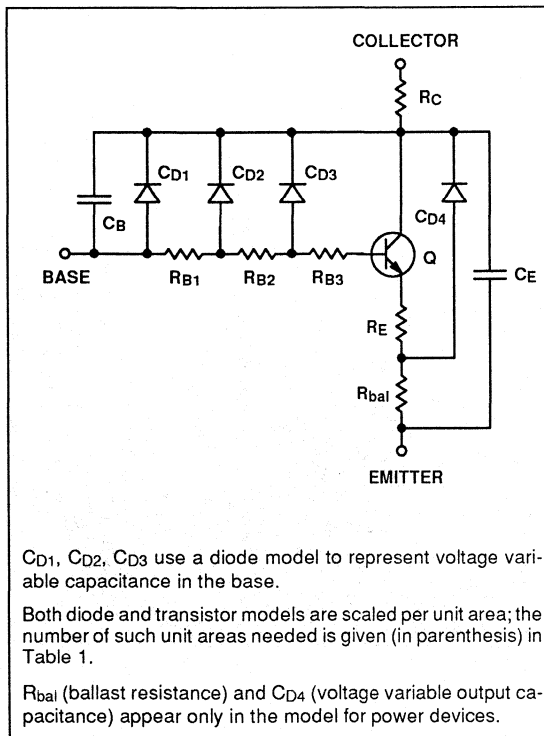

Figure 1. Discrete Transistor SPICE Equivalent Circuit

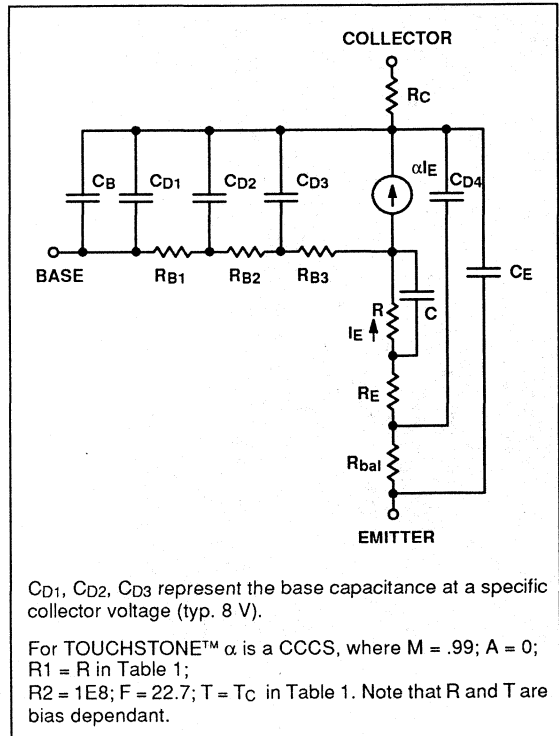

Figure 2. Discrete Transistor Linear Model Equivalent Circuit

All models are completed by adding the bond pad capacitances (C_E and C_B).

A schematic showing the SPICE equivalent circuit used to model the discrete bipolar transistors is given in Figure 1. Figure 2 shows the linear model equivalent circuit. Table 1 lists the values of the circuit elements for the linear model at both low noise and power biases, and for the non-linear SPICE model.

MODAMP™ silicon MMICs consist of two bipolar transistors in a Darlington connection, embedded in a network of resistors to provide both feedback and DC bias. Models for these devices consist of two active device models (Q_1 and Q_2), values for the feedback resistors (R_E and R_F), values for the bias resistors (R_B and R_{bias}), and the parasitic capacitors (C_{P1} , C_{P2} , C_{P3} , and C_F) associated with the structure. Note that no C_B or C_E elements exist in the device simulations incorporated in the MODAMP device models as the bond pad capacitances are included at the MMIC level. The interconnection for these elements is shown schematically in Figure 3. Some MODAMPs (the MSA-05XX, MSA-09XX, MSA-10XX, and MSA-11XX) require DC blocking capacitors in series with the shunt feedback resistor to prevent excess power dissipation on the chip. A schematic for this kind of MODAMP is shown in Figure 4. Tables 2 and 3 give the value of the model elements for both kinds of MODAMPs.

The SPICE simulations require a set of SPICE parameters, which are included in Table 4. Since the same fabrication process is used for the bipolar products described here, one basic set of parameters can be used in the models. Changes in epi material between the discrete transistors, the MODAMP MMICs, and the power devices do, however, result in changes in the parameters BF, VA, TF, and PTF for these three groups of devices. To facilitate the use of a "process description" set of parameters, a "unit transistor" is defined for each kind of de-

vice (QMSA for MODAMP MMICs, QDIS for discretes, QPWR for power devices). Individual device models are then constructed using an appropriate number of these unit blocks. The non-linear base capacitances are built up from a "unit diode" model (DMOD) in a similar fashion. The number in parenthesis in the columns labeled Q, C_{D1} , C_{D2} , C_{D3} , and C_{D4} in Tables 2 and 3 are the number of unit transistors or unit diodes needed in the completed SPICE model.

All of the above models are chip level models. To complete device simulations, appropriate package models must be added. The bond wires that connect the device chip to the package (or substrate, in the case of chip use) must also be simulated, as they are NOT included in the above chip models.

The standard Avantek package model treats the leads and internal metallization as transmission lines (T_1 , T_2 , and T_3). Coupling capacitances between the device terminals is included (C_{EB} , C_{BC} , C_{EC}), as are the emitter and base bond wires (L_E and L_B). As the bottom (collector) of the transistor chip is typically die attached directly to the output lead metallization, there is usually no collector bond wire in the simulation. The package model is completed by adding small amounts of series inductance (L_1 , L_2 , L_3) to each device terminal, to simulate the short lengths of lead that occur between circuit and device package. The completed package model is shown schematically in Figure 5. Values for model elements are given in Table 5. The same package models are used for both linear and non-linear simulations.

The style 23 package used for power devices has a different topology from the other packages. It can also incorporate an input matching capacitor (C_{IN}). The equivalent circuit for this package is shown in Figure 6. The associated values shown are for the AT-64023 device.

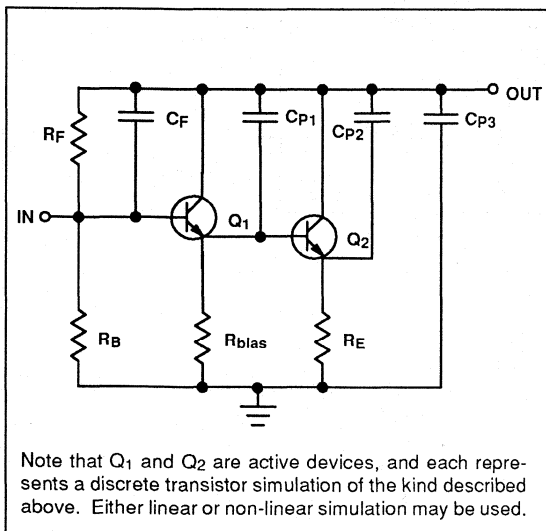

Figure 3. MODAMP MMIC Equivalent Circuit

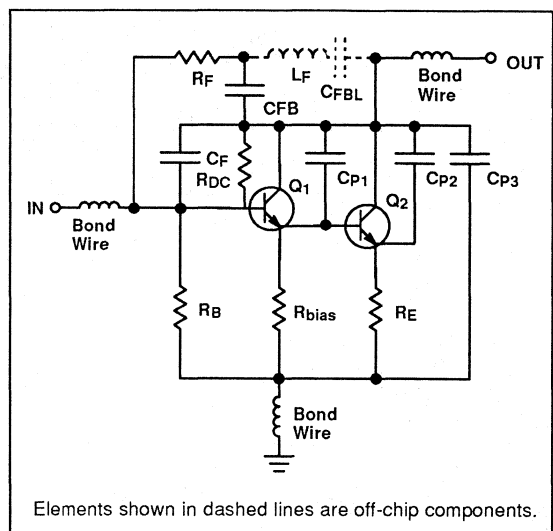

Figure 4. Equivalent Circuit for MODAMP MMICs with DC Blocking Capacitor in Feedback Path

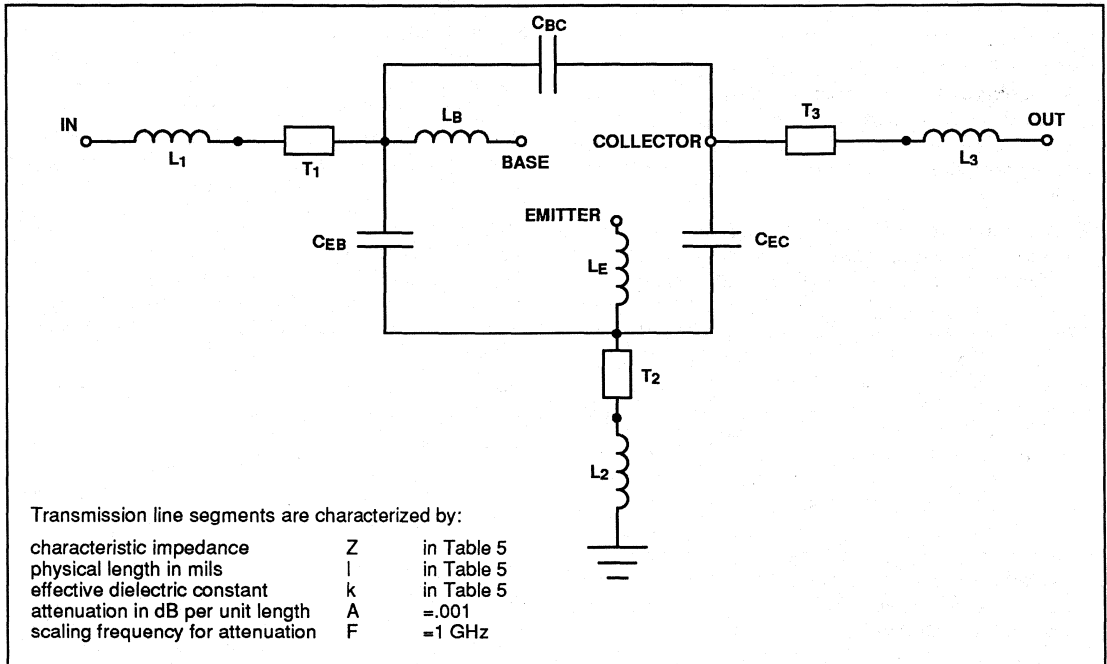

Figure 5. Bipolar Transistor Package Model Equivalent Circuit

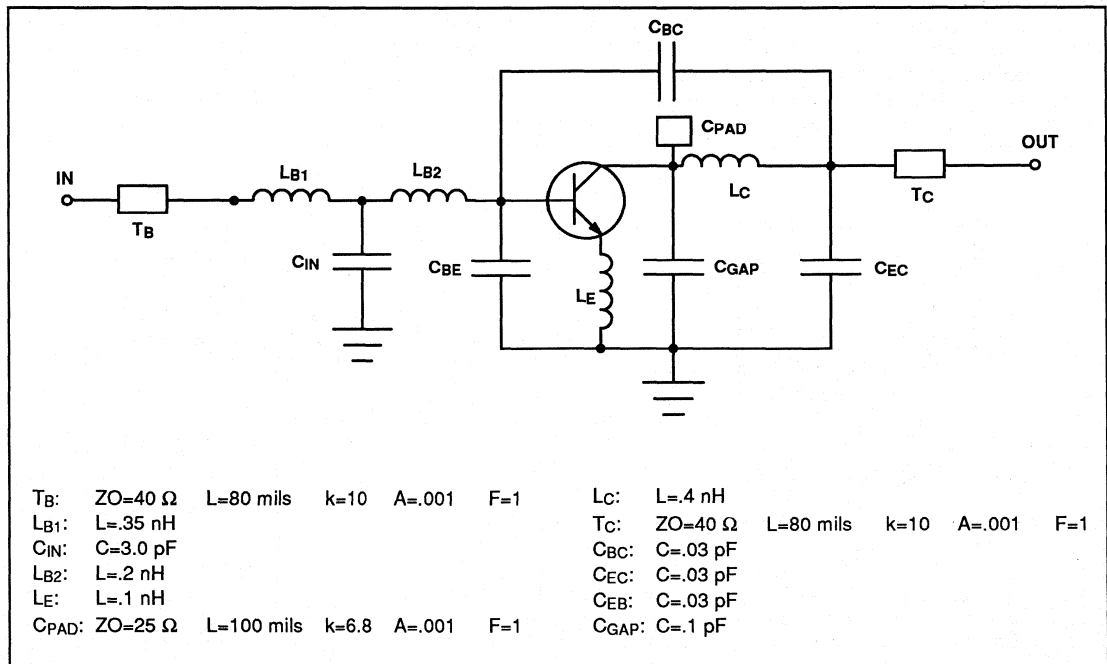

Figure 6. Package Equivalent Circuit For AT-64023

```

DIM
FREQ      GHZ
RES       OH
CAP       PF
IND       NH
LNG       MIL

CKT
! MSA0835 MODEL

! EQUIVALENT CIRCUIT FOR Q1
RES_R1Q1  10  11      R=2.6   TC1=0.8E-3
RES_R2Q1  11  12      R=9.1   TC1=1.2E-3
RES_R3Q1  12  13      R=7.9   TC1=1.8E-3
S1PA_D1Q1 10  15      [MODEL=DMOD 377]
S1PB_D2Q1 11  15      [MODEL=DMOD 218]
S1PC_D3Q1 12  15      [MODEL=DMOD 138]
RES_RCQ1  14  15      R=5     TC1=0.6E-3
RES_REQ1  16  17      R=.63  TC1=0.6E-3
S2PD_Q1   13  15  17   [MODEL=QMOD 156]
DEF3P     10  14  16   Q1

! EQUIVALENT CIRCUIT FOR Q2
RES_R1Q2  20  21      R=1.0   TC1=0.8E-3
RES_R2Q2  21  22      R=3.3   TC1=1.2E-3
RES_R3Q2  22  23      R=2.8   TC1=1.8E-3
S1PA_D1Q2 20  25      [MODEL=DMOD 782]
S1PB_D2Q2 21  25      [MODEL=DMOD 609]
S1PC_D3Q2 22  25      [MODEL=DMOD 386]
RES_RCQ2  24  25      R=5     TC1=0.6E-3
RES_REQ2  26  27      R=.22  TC1=0.6E-3
S2PD_Q2   23  25  27   [MODEL=QMOD 438]
DEF3P     20  24  26   Q2

! MODEL FOR MODAMP MMIC CHIP
RES_RFCH  30  31      R=6000  TC1=-.8E-3
CAP_CFCB  30  31      C=.0001
RES_RBCH  30  32      R=1600  TC1=-.8E-3
Q1_XQ1CH  30  31  33   R=85    TC1=-.8E-3
RES_RB1ASCH 32  33
Q2_XQ2CH  33  31  34   R=.0001 TC1=-.8E-3
RES_RECH  32  34      C=.086
CAP_CP1CH  31  33      C=.021
CAP_CP2CH  31  34      C=.103
CAP_CP3CH  31  32      CHP
DEF3P     30  31  32   ! chip model

! MODEL FOR PACKAGED CHIP - UX PRG (35)
IND_LINP  40  41      L=.05
TLINP_T1P 41  42      Z=65 L=30 K=7 A=0 F=1
IND_LBP   42  43      L=.06
CAP_CBPC  42  47      C=0.02
CAP_CBEP  42  44      C=0.01
IND_LBP   45  44      L=.03
TLINP_T3P 44  46      Z=30 L=15 K=7 A=0 F=1
IND_LBP   46  0       L=.01
CAP_CCEP  44  47      C=0.03
TLINP_T2P 47  48      Z=65 L=50 K=7 A=0 F=1
IND_LOP   48  49      L=.05
CHP_XCHPP 43  47  45   MSA
DEF2P     40  49      ! packaged chip

! PACKAGED CHIP USED IN CIRCUIT
MSA_XA0835 50  53      A0835
DEF2P     50  53

SOURCE
A0835     IVS_VIN  52  0  AC=1   TRAN=SIN(0 100MV 1GHZ) PWR=(0 10 5 1E9 1.5E9 5E8)
A0835     RES_RS   51  52   R=50
A0835     CAP_CS   51  50   C=1000
A0835     IVS_VCC  56  0    DC=12
A0835     RES_RC   55  56   R=90    TC1=.1E-3
A0835     IND_LCK  53  55   L=1E4
A0835     CAP_COUT 53  54   C=1000
A0835     RES_RL   54  0    R=50
    
```

Figure 7A. Typical MW SPICE MSA-0835 Simulation

```

! SPICE PARAMETERS FOR MODAMP TRANSISTOR PROCESS
.MODEL DMOD D IS=1E-25 CJO=2.45E-16 VJ=.76 M=.53 BV=45 IBV=1E-9
.MODEL QMOD NPN BF=90 BR=5 IS=1.65E-18 VA=20 TF=12PS CJE=18E-16
+ PE=1.01 ME=.60 PTF=25 XTB=1.818 VTF=6 ITF=.3MA IK=.1333MA XTF=4
+ NF=1.03 ISE=5E-15 NE=2.5
    
```

Figure 7B. QMSA-MOD File Used in Figure 7A

Device Modeling

Model		Geometry:		41400	42000	60100	60200	60500	64000	00500	01600
Resistors:	RB1	value	Ω	1.0	0.7	19.6	10.2	4.2	0.4	4.9	1.6
		temp coeff	ppm/ $^{\circ}$ C	0.8E-3	0.8E-3	0.8E-3	0.8E-3	0.8E-3	0.8E-3	0.8E-3	0.8E-3
	RB2	value	Ω	3.1	2.2	51.7	25.9	10.3	1.2	8.9	2.8
		temp coeff	ppm/ $^{\circ}$ C	1.2E-3	1.2E-3	1.2E-3	1.2E-3	1.2E-3	1.2E-3	1.2E-3	1.2E-3
	RB3	value	Ω	2.7	1.9	37.5	18.8	7.5	0.9	4.9	1.5
		temp coeff	ppm/ $^{\circ}$ C	1.8E-3	1.8E-3	1.8E-3	1.8E-3	1.8E-3	1.8E-3	1.8E-3	1.8E-3
RC	value	Ω	5	5	5	5	5	1.3	5	5	
	temp coeff	ppm/ $^{\circ}$ C	0.6E-3	0.6E-3	0.6E-3	0.6E-3	0.6E-3	0.6E-3	0.6E-3	0.6E-3	
RE	value	Ω	0.24	0.17	3.32	1.66	0.66	.06	0.39	0.14	
	temp coeff	ppm/ $^{\circ}$ C	0.6E-3	0.6E-3	0.6E-3	0.6E-3	0.6E-3	0.6E-3	0.6E-3	0.6E-3	
Rbal	value	Ω	-	-	-	-	-	1.66	-	-	
	temp coeff	ppm/ $^{\circ}$ C	-	-	-	-	-	0.8E-3	-	-	
Capacitors:	CB	-	pF	.032	.034	.025	.025	.026	.082	.157	.176
	CD1	SPICE	#	(782)	(1051)	(197)	(242)	(377)	(2287)	(546)	(1262)
		lin. @ 8 V	pF	.059	.080	.015	.018	.029	.122'	.041	.096
	CD2	SPICE	#	(629)	(899)	(103)	(206)	(515)	(4692)	(1586)	(5074)
		lin. @ 8 V	pF	.048	.068	.008	.016	.039	.251'	.120	.384
	CD3	SPICE	#	(365)	(522)	(26)	(52)	(131)	(1360)	(189)	(605)
lin. @ 8 V		pF	.023	.040	.002	.004	.010	.071'	.014	.046	
CE	-	pF	.032	.034	.025	.025	.026	.108	.157	.176	
CD4	SPICE	#	-	-	-	-	-	(1717)	-	-	
	lin. @ 16 V	pF	-	-	-	-	-	.104	-	-	
Active Device:	Q	model	-	QDIS	QDIS	QDIS	QDIS	QDIS	QPWR	QDIS	QDIS
		SPICE	#	(420)	(600)	(30)	(60)	(150)	(1560)	(228)	(730)
LN: low noise bias	R	value @ LN	Ω	2.6	2.6	51.5	28.5	12.9	-	5.2	0.8
		value @ G	Ω	1.1	0.8	10.4	5.2	2.6	0.3	1.3	0.5
G: gain or power bias	C	value @ 8 V	pF	2.1	3.00	0.15	0.30	0.75	7.8'	1.14	3.65
		TC	value @ LN	psec	6.9	6.9	6.9	6.9	6.9	-	6.9
		value @ G	psec	7.3	7.3	7.9	7.9	7.3	11.35	8.2	8.1

1. 64000 values given at 16 V

Table 1. Bipolar SPICE and Linear Model Equivalent Circuit Element Values

Model		Geometry:		A01		A02		A03		A04				
				Q1	Q2	Q1	Q2	Q1	Q2	Q1	Q2			
Active Device Subcircuits	Resistors	Nominal Value @ 25°C	RB1	value	Ω	5.0	3.1	5.0	2.5	3.1	1.7	1.7	1.0	
				temp coeff	ppm/°C	0.8E-3	0.8E-3	0.8E-3	0.8E-3	0.8E-3	0.8E-3	0.8E-3	0.8E-3	0.8E-3
			RB2	value	Ω	13.2	8.2	13.2	6.6	8.2	4.4	4.4	4.4	2.6
				temp coeff	ppm/°C	1.2E-3	1.2E-3	1.2E-3	1.2E-3	1.2E-3	1.2E-3	1.2E-3	1.2E-3	1.2E-3
			RB3	value	Ω	9.9	6.2	9.9	5.0	6.2	3.3	3.3	3.3	2.0
		temp coeff	ppm/°C	1.8E-3	1.8E-3	1.8E-3	1.8E-3	1.8E-3	1.8E-3	1.8E-3	1.8E-3	1.8E-3		
		RC	value	Ω	5	5	5	5	5	5	5	5	5	
			temp coeff	ppm/°C	0.6E-3	0.6E-3	0.6E-3	0.6E-3	0.6E-3	0.6E-3	0.6E-3	0.6E-3	0.6E-3	
		RE	value	Ω	0.78	0.49	0.78	0.39	0.49	0.26	0.26	0.26	0.16	
			temp coeff	ppm/°C	0.6E-3	0.6E-3	0.6E-3	0.6E-3	0.6E-3	0.6E-3	0.6E-3	0.6E-3	0.6E-3	
		Capacitors	CD1	SPICE	#	(348)	(478)	(348)	(564)	(478)	(780)	(780)	(1204)	
				linear	pF	.036	.050	.036	.058	.050	.081	.081	.125	
				SPICE	#	(390)	(624)	(390)	(780)	(624)	(1170)	(1131)	(1885)	
				linear	pF	.041	.065	.041	.081	.065	.121	.117	.195	
			CD3	SPICE	#	(114)	(182)	(114)	(228)	(182)	(342)	(331)	(551)	
				linear	pF	.012	.019	.012	.024	.019	.035	.034	.057	
	Intrinsic Device	Non-linear	Q	model	-	QMSA	QMSA	QMSA	QMSA	QMSA	QMSA	QMSA		
				SPICE	#	(125)	(200)	(125)	(250)	(200)	(375)	(375)	(625)	
				R	linear	Ω	7.39	3.47	5.18	2.61	5.18	1.32	3.06	1.00
				C	linear	pF	.625	1.000	.625	1.250	1.000	1.875	1.875	3.125
		TC	linear	psec	4.97	5.04	5.00	5.06	4.96	5.14	5.02	5.09		
MMIC Subcircuit	Resistors	RF		Ω	550		330		330		230			
		RE		Ω	0		5		6.86		11			
		RB		Ω	245		156		170		122			
		RBIAS		Ω	250		167		190		134			
			temp coeff	ppm/°C	-0.8E-3		-0.8E-3		-0.8E-3		-0.8E-3			
		RF, RE, RB, RBIAS												
	Capacitors	CF		pF	.12		.12		.12		.12			
		CP1		pF	.033		.033		.033		.033			
		CP2		pF	-		-		-		-			
CP3			pF	.103		.103		.103		.103				

Table 2. MODAMP MMIC Linear and SPICE Models

Device Modeling

Model		Geometry:		A06		A07		A08			
				Q1	Q2	Q1	Q2	Q1	Q2		
Active Device Subcircuits	Resistors	Nominal Value @ 25°C	R _{B1}	value temp coeff	Ω ppm/°C	0.95 0.8E-3	0.95 0.8E-3	1.5 0.8E-3	1.2 0.8E-3	2.6 0.8E-3	1.0 0.8E3
			R _{B2}	value temp coeff	Ω ppm/°C	3.26 1.2E-3	3.26 1.2E-3	4.4 1.2E-3	3.1 1.2E-3	9.1 1.2E-3	3.3 1.2E-3
			R _{B3}	value temp coeff	Ω ppm/°C	2.83 1.8E-3	2.83 1.8E-3	3.8 1.8E-3	2.7 1.8E-3	7.9 1.8E-3	2.8 1.8E-3
			R _C	value temp coeff	Ω ppm/°C	10 0.6E-3	10 0.6E-3	10 0.6E-3	10 0.6E-3	5 0.6E-3	5 0.6E-3
			R _E	value temp coeff	Ω ppm/°C	0.22 0.6E-3	0.22 0.6E-3	0.33 0.6E-3	0.24 0.6E-3	0.63 0.6E-3	0.22 0.6E-3
	Capacitors	C _{D1}	SPICE linear	# pF	(782) .102	(782) .090	(602) .071	(782) .083	(377) .039	(782) .081	
		C _{D2}	SPICE linear	# pF	(609) .082	(609) .072	(450) .053	(629) .066	(218) .023	(609) .063	
		C _{D3}	SPICE linear	# pF	(386) .048	(386) .042	(261) .031	(365) .039	(138) .014	(385) .040	
	Intrinsic Device	Non-linear	Q	model SPICE	- #	QMSA (438)	QMSA (438)	QMSA (300)	QMSA (420)	QMSA (156)	QMSA (438)
			R	linear	Ω	5.16	3.45	6.29	2.43	2.64	1.09
		Linear	C	linear	pF	2.19	2.19	1.50	2.10	.78	2.19
			T _C	linear	psec	3.96	4.53	5.77	5.85	5.13	5.14
	MMIC Subcircuit	Resistors	R _F		Ω	600		360		6000	
			R _E		Ω	0		6		0	
			R _B		Ω	480		244		1600	
R _{BIAS}				Ω	157		215		85		
temp coeff				ppm/°C	-0.8E-3		-0.8E-3		-0.8E-3		
Capacitors		C _F		pF	.083		.067		-		
		C _{P1}		pF	.019		.020		.086		
		C _{P2}		pF	.010		.045		.021		
		C _{P3}		pF	.085		.104		.134		

Table 2. MODAMP MMIC Linear and SPICE Models (contd.)

Model		Geometry:		A05		A09		A10		A11				
				Q1	Q2	Q1	Q2	Q1	Q2	Q1	Q2			
Active Device Subcircuits	Resistors	Nominal Value @ 25°C	RB1	value	Ω	1.26	0.91	2.6	1.0	0.9	0.7	0.42	.67	
				temp coeff	ppm/°C	0.8E-3	0.8E-3	0.8E-3	0.8E-3	0.8E-3	0.8E-3	0.8E-3	0.8E-3	0.8E-3
			RB2	value	Ω	2.15	1.07	9.1	3.3	1.1	0.6	1.42	2.3	
				temp coeff	ppm/°C	1.2E-3	1.2E-3	1.2E-3	1.2E-3	1.2E-3	1.2E-3	1.2E-3	1.2E-3	1.2E-3
			RB3	value	Ω	1.56	0.78	7.9	2.8	0.8	0.4	1.24	2.0	
				temp coeff	ppm/°C	1.8E-3	1.8E-3	1.8E-3	1.8E-3	1.8E-3	1.8E-3	1.8E-3	1.8E-3	1.8E-3
		RC	value	Ω	5.87	3.00	5	5	2.7	1.24	5	5		
			temp coeff	ppm/°C	0.6E-3	0.6E-3	0.6E-3	0.6E-3	0.6E-3	0.6E-3	0.6E-3	0.6E-3		
		RE	value	Ω	0.14	0.07	.63	.22	0.7	0.3	0.10	0.16		
			temp coeff	ppm/°C	0.6E-3	0.6E-3	0.6E-3	0.6E-3	0.6E-3	0.6E-3	0.6E-3	0.6E-3		
		Rbal	value	Ω	2.75	1.38	-	-	1.38	0.69	-	-		
			temp coeff	ppm/°C	0.6E-3	0.6E-3	-	-	0.6E-3	0.6E-3	-	-		
		Capacitors	CD1	SPICE	#	(1267)	(2354)	(377)	(782)	(2354)	(4530)	(1591)	(1051)	
				linear	pF	.077	.136	.028	.055	.122	.226	.146	.090	
			CD2	SPICE	#	(2380)	(4760)	(218)	(609)	(4760)	(9520)	(1392)	(870)	
				linear	pF	.145	.276	.016	.043	.247	.474	.128	.075	
	CD3	SPICE	#	(612)	(1224)	(138)	(385)	(1224)	(2448)	(882)	(551)			
		linear	pF	.037	.071	.010	.027	.063	.122	.081	.047			
	CD4	SPICE	#	(1717)	(1717)	-	-	(1717)	(1717)	-	-			
		linear	pF	.100	.096	-	-	.086	.083	-	-			
	Intrinsic Device	Non-linear	Q	model	-	QPWR	QPWR	QMSA	QMSA	QPWR	QPWR	QMSA	QMSA	
				SPICE	#	(720)	(1440)	(156)	(438)	(1440)	(2880)	(1000)	(625)	
			R	linear	Ω	.49	.25	2.60	1.04	0.24	0.14	1.63	0.62	
			C	linear	pF	3.60	7.20	0.78	2.19	7.20	14.40	5.00	3.13	
		TC	linear	psec	8.44	8.92	5.13	5.14	10.20	10.55	5.79	6.31		
MMIC Subcircuit	Resistors	RF		Ω	210		150		120		300			
		RE		Ω	15		12		8.73		10			
		RB		Ω	800		2000		270		2400			
		RBIAS		Ω	50		115		25		80			
		RDC		Ω	2000		6000		900		4000			
			temp coeff	ppm/°C	-0.8E-3		-0.8E-3		-0.8E-3		-0.8E-3			
			RF, RE, RB, RBIAS, RDC											
	Capacitors	CF		pF	.26		.114		.33		.10			
		CFB		pF	-		.058		-		.058			
		CP1		pF	.274		.020		.52		.050			
		CP2		pF	.150		.023		.230		.080			
		CP3		pF	.496		.168		.790		.120			
		CFBL		pF	45		45		80		200			
	LF		nH	.35		.35		1.00		.35				

Table 3. MODAMP MMICs with DC Blocked Shunt Feedback Linear and SPICE Models

Device Modeling

Model Name:	DMOD
Model Type:	D
IS	1E-25
CJO	2.45E-16
VJ	.76
M	.53
BV	45
IBV	1E-9

Model Name:	QDIS	QPWR	QMSA
Model Type:	NPN	NPN	NPN
BF	100	75	90
BR	5	5	5
IS	1.65E-18	1.65E-18	1.65E-18
VA	20	30	20
TF	12PS	14PS	12PS
CJE	1.8E-15	1.8E-15	1.8E-15
PE	1.01	1.01	1.01
ME	.60	.60	.60
PTF	35	50	25
XTB	1.818	1.818	1.818
VTF	6	6	6
ITF	.3 MA	.3 MA	.3 MA
IK	.100 MA	.100 MA	.1333 MA
XTF	4	4	4
NF	1.03	1.03	1.03
ISE	5E-15	5E-15	5E-15
NE	2.5	2.5	2.5

Table 4. SPICE Parameter Values

Package Style:		00	04	05	10	11	20	35	70	85	86
L _B	nH	.5	.6	.6	.65	.5	.55	.6	.5	.55	.55
L _E	nH	.2	.2	.2	.1	.25	.2	.3	.14	.1	.1
L ₁	nH	—	.05	.15	.05	.05	.05	.05	.05	.05	.55
L ₂	nH	—	.01	.06	.01	.01	.01	.01	.01	.01	.06
L ₃	nH	—	.05	.05	.05	.05	.05	.05	.05	.05	.25
T ₁ : Z : l : k	Ω	—	55	55	45	45	50	65	40	65	65
	mils	—	80	80	40	50	80	35	25	30	30
	—	—	9	9	7	5	4.8	7	7	9	9
T ₂ : Z : l : k	Ω	—	25	25	35	30	25	30	20	30	30
	mils	—	30	30	10	20	25	15	5	10	10
	—	—	9	9	7	5	5.3	7	7	9	9
T ₃ : Z : l : k	Ω	—	55	55	45	45	50	65	40	60	60
	mils	—	60	60	45	60	155	50	35	20	20
	—	—	9	9	7	5	4.8	7	7	9	9
CEB	pF	—	.03	.03	.03	.04	.04	.01	.02	.02	.02
CEC	pF	—	.04	.04	.03	.01	.02	.03	.01	.03	.03
CBC	pF	—	.04	.04	.05	.04	.02	.02	.02	.03	.03

Table 5. Circuit Element Values for Bipolar Package Models

Device Modeling

FET MODELS

At present only linear models are available for the GaAs FET devices in this catalog. The FET model given is a simplified hybrid pi model. The intrinsic FET consists of a voltage controlled current source ($g_m V_c$), the capacitance (C_{gs}) across which the controlling voltage appears, and the input resistance (R_c). Terminal contact resistances (R_g , L_g , R_s) and parasitic inductances (L_s , L_d) then are added to this structure. Included in the values for L_g , L_s , and L_d are both the inductance of the on-chip traces and the bond wire inductances used for carrier measurements. The drain resistance (R_d) is sufficiently low in value that it does not influence the s-pa-

rameters or noise performance in the frequency range where the model is applicable (up to ~ 20 GHz), it does not appear in the model. The gate-to-drain coupling capacitance (C_{gd}) — which is the predominant determinant of S_{12} — and the output capacitance (C_{ds}) complete the model. The schematic of the FET model equivalent circuit is shown in Figure 8. Component values for both low noise and gain bias are given in Table 6.

The topology derived for the bipolar package model can also be applied to GaAs FET packages, with one additional element being required. Since the bottom of the bipolar die is also the output terminal, bipolars in general do not require output (collector) bond wires. In contrast, the bottom of a GaAs FET

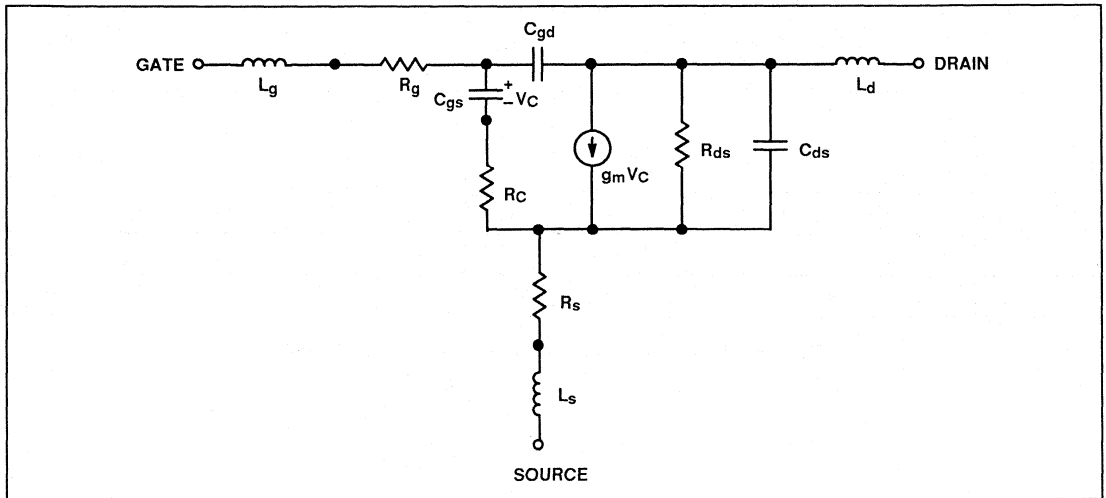

Figure 8. Equivalent Circuit for Linear GaAs FET Models

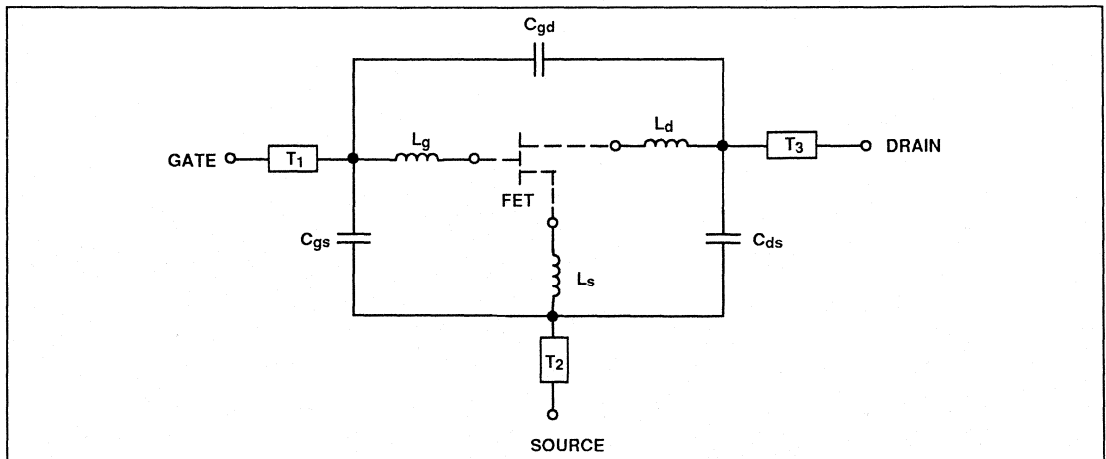

Figure 9. Equivalent Circuit for Package Models

is either electrically isolated or connected to the common terminal, so an output (drain) bond wire (L_d) is required. The consequent differences in metallization patterns means that although the model topology stays the same, the values of the model elements change. Thus, even though a FET package may have the same external appearance and numeric designation

as a bipolar package, it will have different values for its equivalent circuit elements — a FET style 70 package model will not be the same as a bipolar style 70 package model. For convenience, the package model is repeated in Figure 9 with the appropriate labels for a GaAs FET. Values for this model are listed in Table 7 for the various FET package styles.

#	[1]	[2]	[3]	[4]	[5]	[6]	[7]	[8]	[9]	[10]			
Part	L_g nH	L_d nH	L_s nH	R_c Ω	R_g Ω	R_s Ω	C_{gs} pF	C_{gd} pF	C_{ds} pF	gm mS	TF ps	R_{ds} Ω	QF —
ATF-101XX 2V, 20 mA	.9	.6	.15	2.0	2.5	2.0	.25	.10	.10	70	.001	200	0.8
ATF-102XX 2V, 20 mA	.9	.6	.15	2.0	2.5	2.0	.40	.10	.10	60	.001	200	0.6
ATF-107XX 2V, 20 mA	.9	.6	.15	2.0	3.0	2.0	.40	.15	.10	60	.001	200	1.0
4V, 70 mA	.9	.6	.15	4.0	5.0	2.0	.80	.10	.20	130	.001	200	1.4
ATF-131XX/132 3V, 20 mA	.9	.6	.15	2.0	3.0	0.5	.14	.05	.03	50	.001	250	1.5
ATF-133XX/134 3V, 20 mA	.9	.6	.15	2.0	3.0	0.5	.20	.05	.03	40	.001	250	1.0
ATF-137XX 3V, 20 mA	.9	.6	.15	2.0	3.0	0.5	.20	.05	.03	40	.001	250	1.5
4V, 20 mA	.9	.6	.15	2.0	3.0	0.5	.24	.05	.03	50	.001	250	1.9
ATF-211XX 3V, 30 mA	.4	.5	.15	1.5	1.5	1.0	.70	.10	.14	68	.001	180	0.6
5V, 80 mA	.4	.5	.15	1.0	1.0	0.5	1.2	.08	.15	115	.001	180	1.0
ATF-251XX 3V, 20 mA	.4	.7	.15	2.0	2.5	1.0	.36	.07	.16	48	.001	150	0.8
5V, 50 mA	.4	.7	.15	1.0	2.0	0.5	.60	.06	.08	75	.001	180	1.2
ATF-261XX 3V, 10 mA	.6	.7	.15	2.0	5.0	5.0	.16	.03	.06	27	.001	275	0.6
5V, 30 mA	.6	.7	.15	2.0	5.0	5.0	.26	.015	.06	42	.001	275	1.0

Note: This table represents the product as die mounted on a chip carrier. Use Table 7 to convert to packaged product.

Table 6. Circuit Element Values for Linear GaAs FET Models

Pkg	L_g nH	L_d nH	L_s nH	T1			T2			T3			C_{gs} pF	C_{ds} pF	C_{gd} pF
				Z Ω	l mil	k —	Z Ω	l mil	k —	Z Ω	l mil	k —			
00	Included in chip model			—			—			—			—	—	—
35	.9	.6	.15	65	35	7	30	15	7	65	35	7	.05	.05	.005
50	.5	.8	.15	65	15	7	30	5	7	65	20	7	.1	.1	.005
70	.5	.5	.15	40	25	7	20	5	7	40	25	7	.05	.05	.005
84	.5	.5	.15	65	25	9	30	7	9	65	25	9	.03	.05	.010

Note: Both die and package models include inductance values for the gate, drain, drain and source bond wires. (L_g , L_d , L_s). When placing the die model in a package model, use the bond wire value given in the package description and omit the values given in the die model.

Table 7. Circuit Element Values for FET Package Models

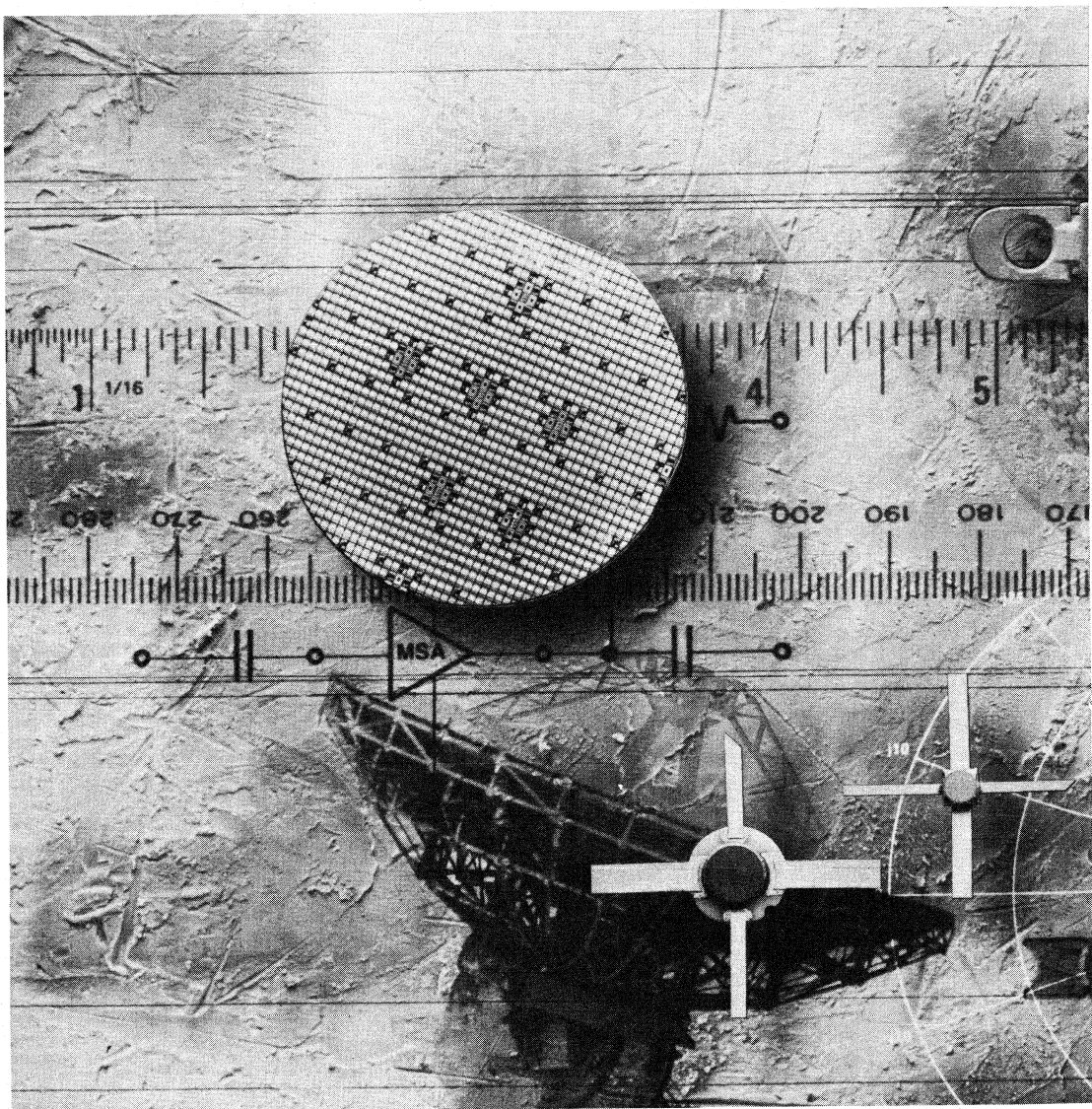

Packaging

PACKAGE OUTLINE DRAWINGS . . . 9-2

TAPE-AND-REEL PACKAGING
FOR SURFACE MOUNT
SEMICONDUCTORS 9-7

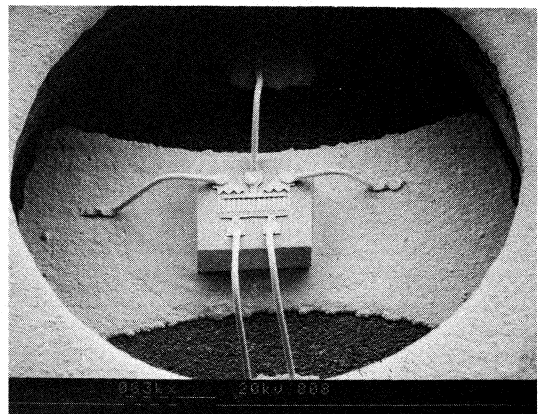
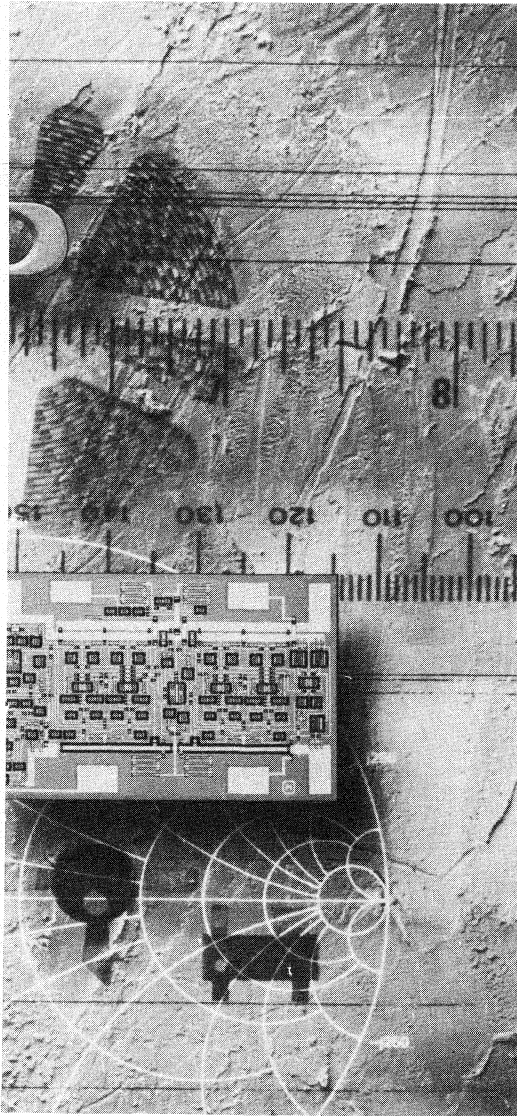

01: 100 mil Flange (D)

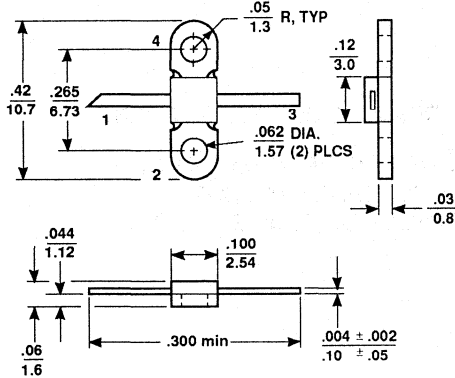

04: 145 mil Plastic (B)

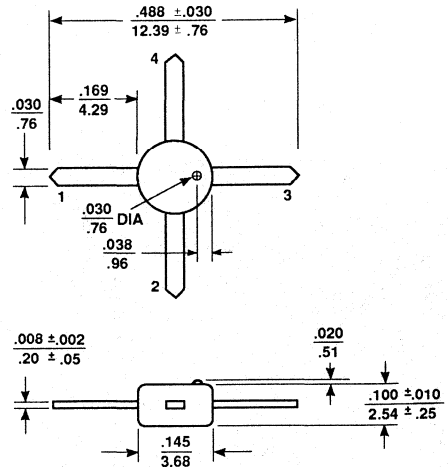

05: 145 mil Surface Mount Plastic (B)

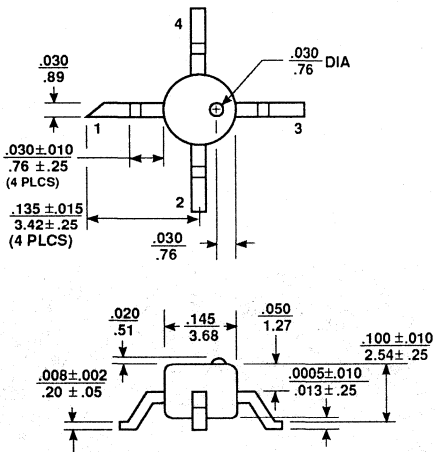

10: 100 mil Stripline (A, B)

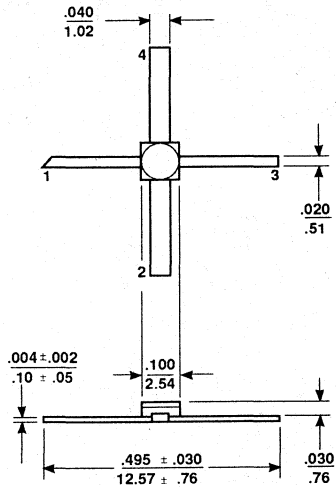

	LEAD	1	2	3	4
A	Silicon Bipolar Transistor	Base	Emitter	Collector	Emitter
B	MODAMP™ MMICs	RF Input	Ground	RF Output and Bias	Ground
C	Silicon MMIC Frequency Converters	RF Input	Ground	RF Output and Bias	Ground
D	GaAs FET	Gate	Source	Drain	Source

Notes:
(unless otherwise specified)

1. Dimensions are $\frac{\text{in}}{\text{mm}}$
2. Tolerances
in .xxx = ± .005
mm .xx = ± .13

11: SOT-143 Plastic (A, B)

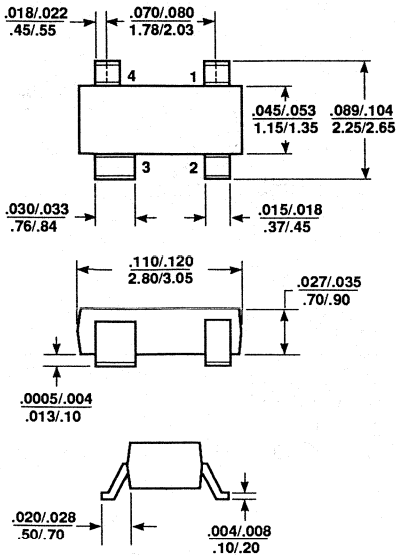

18: 180 mil Surface Mount

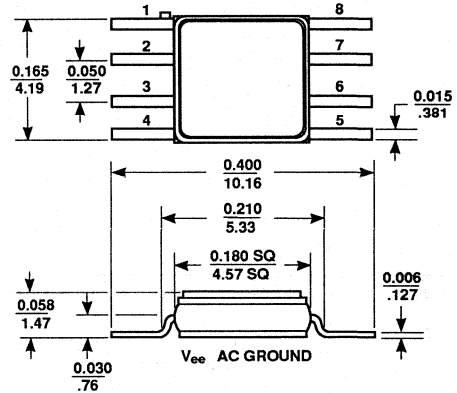

20: 200 mil BeO (A, B)

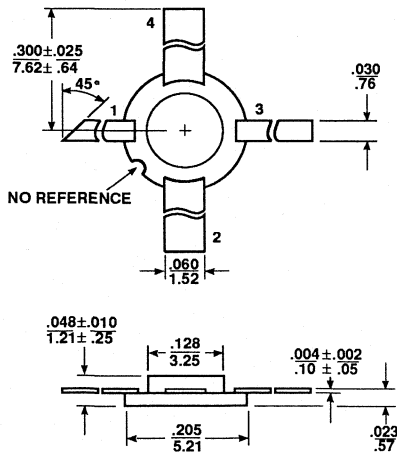

23: 230 mil BeO Flange (A, B)

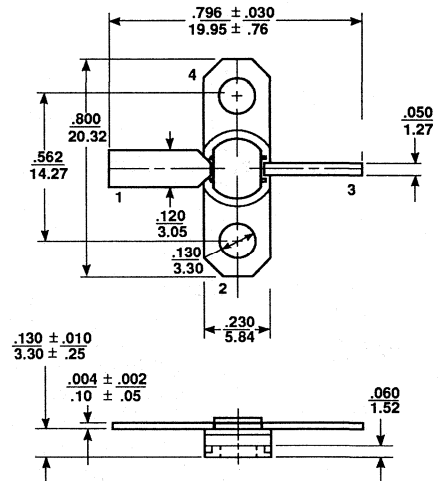

	LEAD	1	2	3	4
A	Silicon Bipolar Transistor	Base	Emitter	Collector	Emitter
B	MODAMP™ MMICs	RF Input	Ground	RF Output and Bias	Ground
C	Silicon MMIC Frequency Converters	RF Input	Ground	RF Output and Bias	Ground
D	GaAs FET	Gate	Source	Drain	Source

Notes:
 (unless otherwise specified)
 1. Dimensions are $\frac{\text{in}}{\text{mm}}$
 2. Tolerances
 in .xxx = $\pm .005$
 mm .xx = $\pm .13$

Case Drawings

35: micro-X (A, B, C, D)

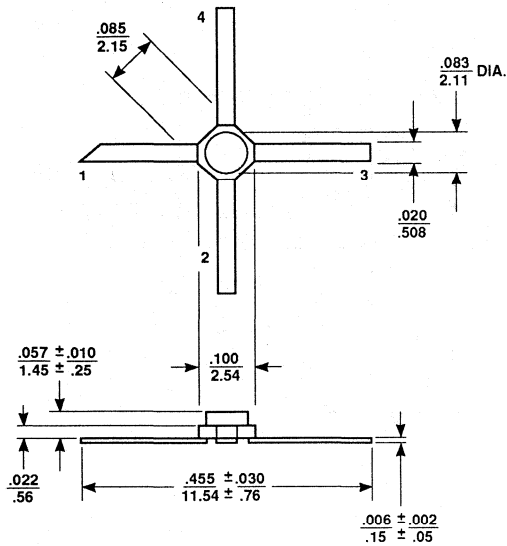

36: Short Lead micro-X (B, D)

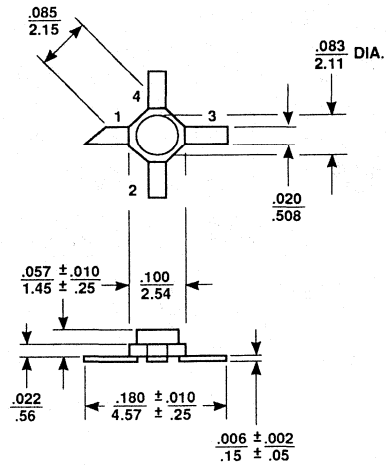

50: 50 mil Stripline (D)

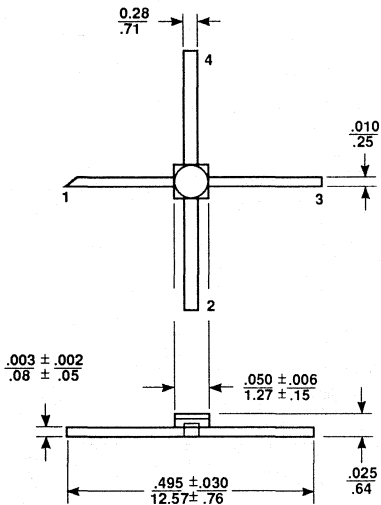

	LEAD	1	2	3	4
A	Silicon Bipolar Transistor	Base	Emitter	Collector	Emitter
B	MODAMP™ MMICs	RF Input	Ground	RF Output and Bias	Ground
C	Silicon MMIC Frequency Converters	RF Input	Ground	RF Output and Bias	Ground
D	GaAs FET	Gate	Source	Drain	Source

Notes:
(unless otherwise specified)

1. Dimensions are $\frac{\text{in}}{\text{mm}}$
2. Tolerances
in .xxx = ± .005
mm .xx = ± .13

70: 70 mil Stripline (A, B, C, D)

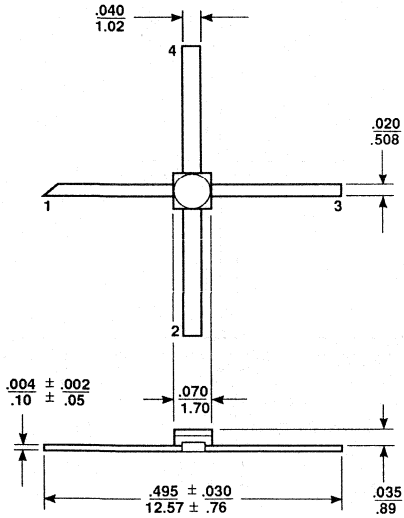

71: 70 mil Flange (D)

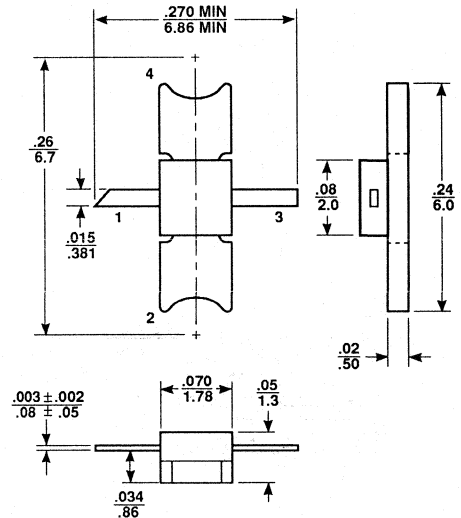

72: TO-72 (A)

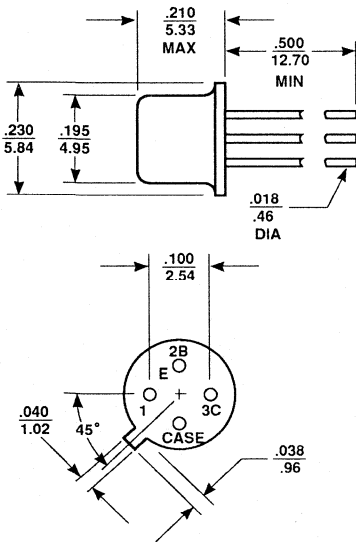

	LEAD	1	2	3	4
A	Silicon Bipolar Transistor	Base	Emitter	Collector	Emitter
B	MODAMP™ MMICs	RF Input	Ground	RF Output and Bias	Ground
C	Silicon MMIC Frequency Converters	RF Input	Ground	RF Output and Bias	Ground
D	GaAs FET	Gate	Source	Drain	Source

Notes:
(unless otherwise specified)

- Dimensions are $\frac{\text{in}}{\text{mm}}$
- Tolerances
in .xxx = ± .005
mm .xx = ± .13

Case Drawings

84: Short Lead 85 mil Plastic (D)

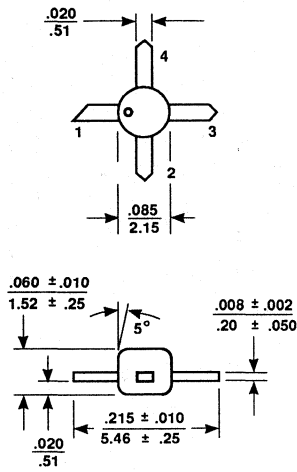

85: 85 mil Plastic (A, B, C)

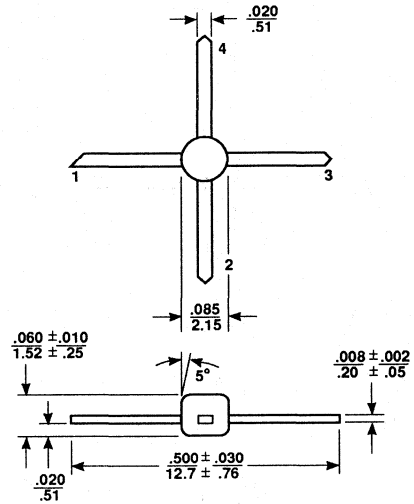

86: 85 mil Surface Mount Plastic (A, B)

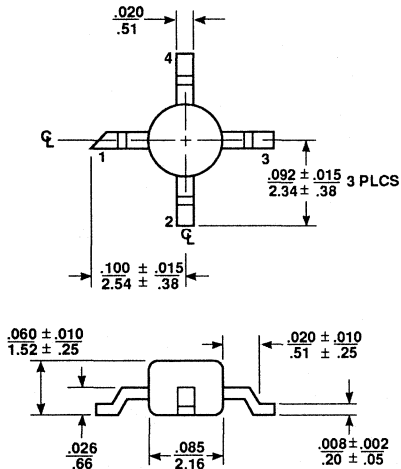

	LEAD	1	2	3	4
A	Silicon Bipolar Transistor	Base	Emitter	Collector	Emitter
B	MODAMP™ MMICs	RF Input	Ground	RF Output and Bias	Ground
C	Silicon MMIC Frequency Converters	RF Input	Ground	RF Output and Bias	Ground
D	GaAs FET	Gate	Source	Drain	Source

Notes:
(unless otherwise specified)

1. Dimensions are $\frac{\text{in}}{\text{mm}}$
2. Tolerances
in .xxx = $\pm .005$
mm .xx = $\pm .13$

Description

Avantek's "Tape-and-Reel Packaging" data sheet describes the packaging options available for Avantek Microwave Semiconductor products.

Tape dimensions, reel dimensions and package outlines are detailed in the following pages. Ordering information is outlined below.

Tape-and-Reel packaging is designed for surface mount devices and is intended for use with automated pick and place equipment.

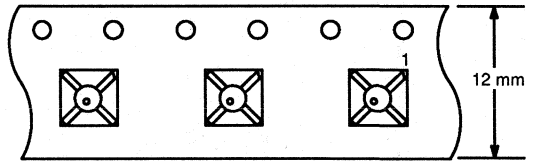
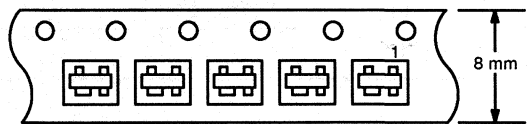
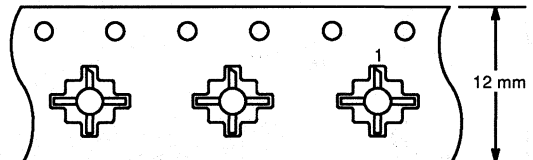
Tape-and-Reel Options
PACKAGE 05:

PACKAGE 11 (SOT-143):

PACKAGE 36, 84 and 86:

Note: 1. Indicates pin 1 orientation.

Part Number Ordering Information

Package Style	Tape Width (mm)	Reel Size	Devices Per Reel	Part Number Suffix
PACKAGE 05	12	7"	500	-TR1
	12	13"	1,500	-TR2
PACKAGE 11	8	7"	3,000	-TR1
	8	13"	10,000	-TR2
PACKAGE 36, 84, 86	12	7"	1,000	-TR1
	12	13"	4,000	-TR2

Notes: 1. Minimum order quantity is one (1) reel.

2. Orders are required to be in increments of the single reel quantity.

3. To order, specify the device part number followed by the appropriate suffix.

Examples:

MSA-1105-TR2
Package 05
13" reel
1,500 devices/reel

MSA-0311-TR1
Package 11
7" reel
3,000 devices/reel

ATF-13136-TR1
Package 36
7" reel
1,000 devices/reel

AT-41486-TR2
Package 86
13" reel
4,000 devices/reel

Tape-and-Reel Packaging for Surface Mount Semiconductors

Tape Dimensions

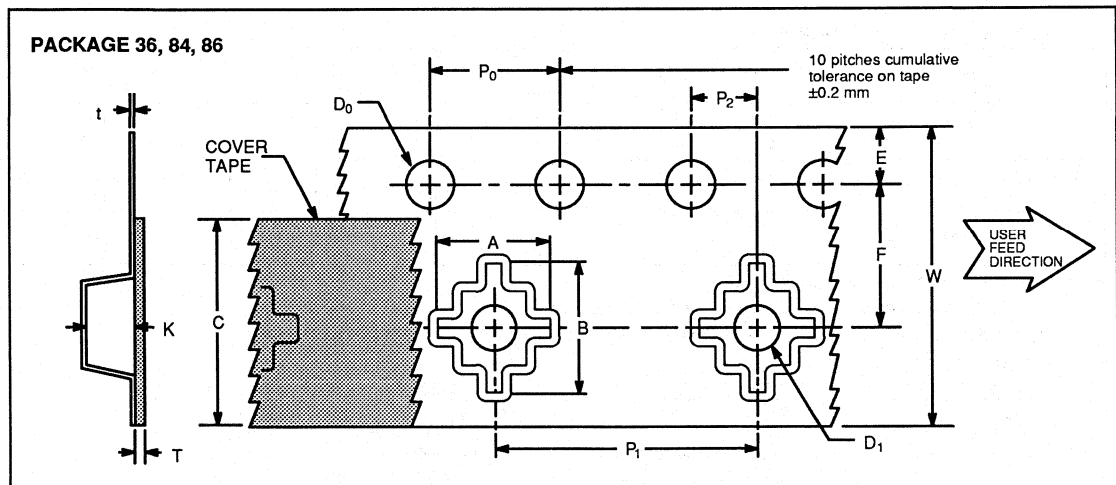
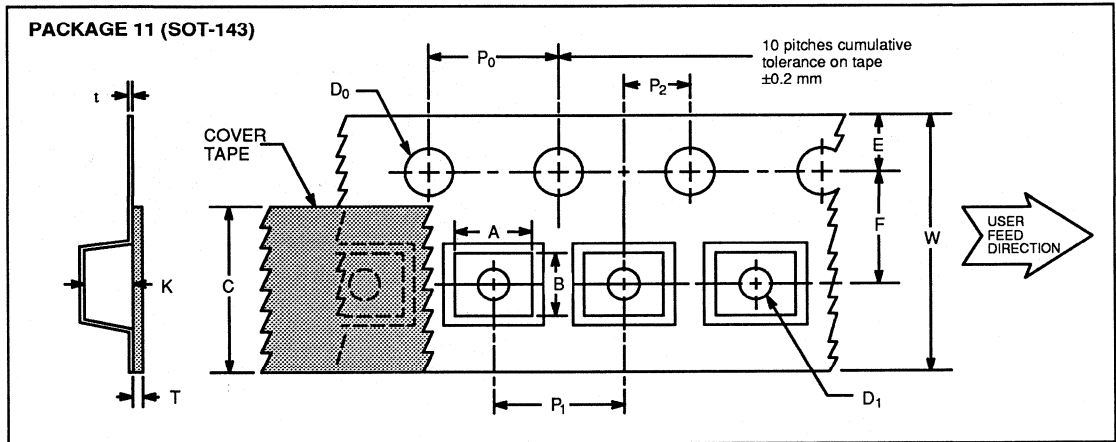
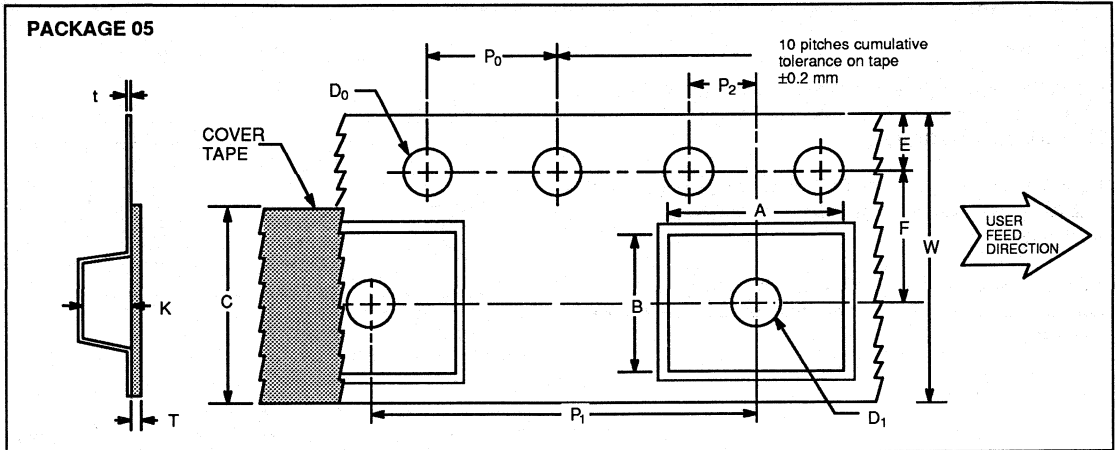

Tape-and-Reel Packaging for Surface Mount Semiconductors

Tape Dimensions

PACKAGE 05				
Description		Symbol	Inches	mm
Cavity	Length	A	.240 ± .004	6.10 ± .10
	Width	B	.240 ± .004	6.10 ± .10
	Depth	K	.125 ± .004	3.18 ± .10
	Pitch	P ₁	.472 ± .004	12.00 ± .10
	Bottom hole diameter	D ₁	.059 min	1.50 min
Perforation	Diameter	D ₀	.059 $\left\{ \begin{array}{l} +.004 \\ -.002 \end{array} \right.$	1.50 $\left\{ \begin{array}{l} +.10 \\ -.05 \end{array} \right.$
	Pitch	P ₀	.157 ± .004	4.00 ± .10
	Position	E	.069 ± .004	1.75 ± .10
Distance between centerline	Cavity to Perforation (Length direction)	P ₂	.079 ± .002	2.00 ± .05
	Cavity to Perforation (Width direction)	F	.217 ± .002	5.50 ± .05
Cover tape	Width	C	.366 ± .004	9.30 ± .10
	Thickness	T	.003 ± .0004	.065 ± .01
Carrier tape	Width	W	.472 ± .008	12.00 ± .20
	Thickness	t	.012 ± .002	0.30 ± .05

PACKAGE 11 (SOT-143)				
Description		Symbol	Inches	mm
Cavity	Length	A	.122 ± .004	3.10 ± .10
	Width	B	.106 ± .004	2.70 ± .10
	Depth	K	.051 ± .004	1.30 ± .10
	Pitch	P ₁	.157 ± .004	4.00 ± .10
	Bottom hole diameter	D ₁	.039 min	1.00 min
Perforation	Diameter	D ₀	.059 $\left\{ \begin{array}{l} +.004 \\ -.002 \end{array} \right.$	1.50 $\left\{ \begin{array}{l} +.10 \\ -.05 \end{array} \right.$
	Pitch	P ₀	.157 ± .004	4.00 ± .10
	Position	E	.069 ± .004	1.75 ± .10
Distance between centerline	Cavity to Perforation (Length direction)	P ₂	.079 ± .002	2.00 ± .05
	Cavity to Perforation (Width direction)	F	.138 ± .002	3.50 ± .05
Cover tape	Width	C	.213 ± .004	5.40 ± .10
	Thickness	T	.003 ± .0004	.065 ± .01
Carrier tape	Width	W	.315 ± .008	8.00 ± .20
	Thickness	t	.012 ± .002	0.30 ± .05

PACKAGE 36, 84, 86				
Description		Symbol	Inches	mm
Cavity	Length	A	.227 ± .004	5.77 ± .10
	Width	B	.240 ± .004	6.10 ± .10
	Depth	K	.067 ± .004	1.70 ± .10
	Pitch	P ₁	.314 ± .004	8.00 ± .10
	Bottom hole diameter	D ₁	.059 min	1.50 min
Perforation	Diameter	D ₀	.059 $\left\{ \begin{array}{l} +.004 \\ -.002 \end{array} \right.$	1.50 $\left\{ \begin{array}{l} +.10 \\ -.05 \end{array} \right.$
	Pitch	P ₀	.157 ± .004	4.00 ± .10
	Position	E	.069 ± .004	1.75 ± .10
Distance between centerline	Cavity to Perforation (Length direction)	P ₂	.079 ± .002	2.00 ± .05
	Cavity to Perforation (Width direction)	F	.217 ± .002	5.50 ± .05
Cover tape	Width	C	.366 ± .004	9.30 ± .10
	Thickness	T	.003 ± .0004	.065 ± .01
Carrier tape	Width	W	.472 ± .008	12.00 ± .20
	Thickness	t	.012 ± .002	0.30 ± .05

Tape-and-Reel Packaging for Surface Mount Semiconductors

Reel Dimensions

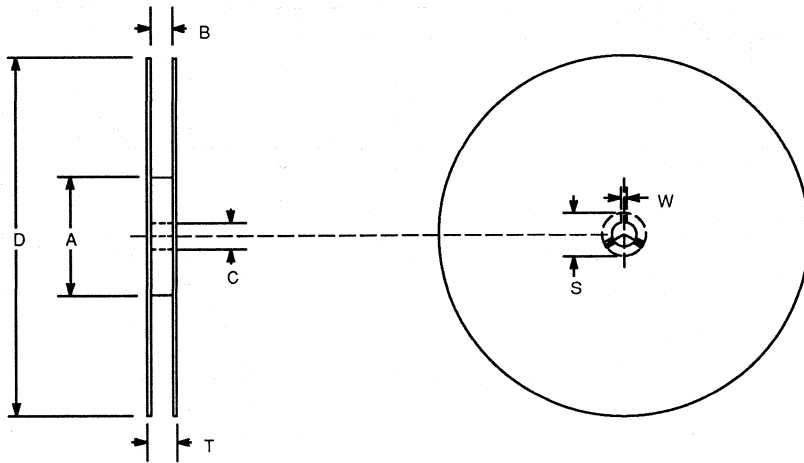

7" Reel

Description		Symbol	PACKAGE 11 (SOT-143)		PACKAGE 05, 36, 84, 86	
			Inches	mm	Inches	mm
Flange	Diameter	D	7.0 ± .079	178 ± 2.0	7.0 ± .079	178 ± 2.0
	Thickness	T	.567 max	14.4 max	.724 max	18.4 max
	Space between flange	B	.331 $\left\{ \begin{array}{l} +.06 \\ -0.0 \end{array} \right.$	8.4 $\left\{ \begin{array}{l} +1.5 \\ -0.0 \end{array} \right.$.488 $\left\{ \begin{array}{l} +.08 \\ -0.0 \end{array} \right.$	12.4 $\left\{ \begin{array}{l} +2.0 \\ -0.0 \end{array} \right.$
Hub	Outer diameter	A	2.16 min	55 min	2.16 min	55 min
	Spindle hole diameter	C	.512 ± .008	13.0 ± 0.2	.512 ± .008	13.0 ± 0.2
	Keyslit width	W	.059 min	1.5 min	.059 min	1.5 min
	Keyslit diameter	S	.795 min	20.2 min	.795 min	20.2 min

13" Reel

Description		Symbol	PACKAGE 11 (SOT-143)		PACKAGE 05, 36, 84, 86	
			Inches	mm	Inches	mm
Flange	Diameter	D	13.0 ± .079	330 ± 2.0	13.0 ± .079	330 ± 2.0
	Thickness	T	.567 max	14.4 max	.724 max	18.4 max
	Space between flange	B	.331 $\left\{ \begin{array}{l} +.06 \\ -0.0 \end{array} \right.$	8.4 $\left\{ \begin{array}{l} +1.5 \\ -0.0 \end{array} \right.$.488 $\left\{ \begin{array}{l} +.08 \\ -0.0 \end{array} \right.$	12.4 $\left\{ \begin{array}{l} +2.0 \\ -0.0 \end{array} \right.$
Hub	Outer diameter	A	2.48 min	63 min	2.48 min	63 min
	Spindle hole diameter	C	.512 ± .008	13.0 ± 0.2	.512 ± .008	13.0 ± 0.2
	Keyslit width	W	.059 min	1.5 min	.059 min	1.5 min
	Keyslit diameter	S	.795 min	20.2 min	.795 min	20.2 min

Packing

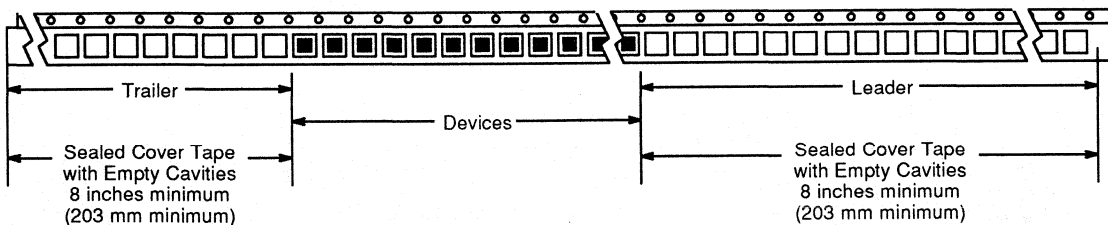

Materials

- Reel: plastic
- Carrier Tape: conductive PVC
surface resistivity; 1.8×10^3 ohms/square
- Cover Tape: semi-transparent polyester

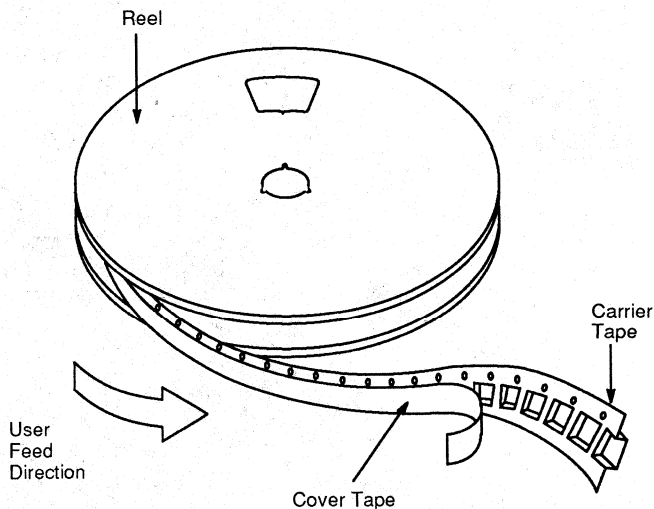

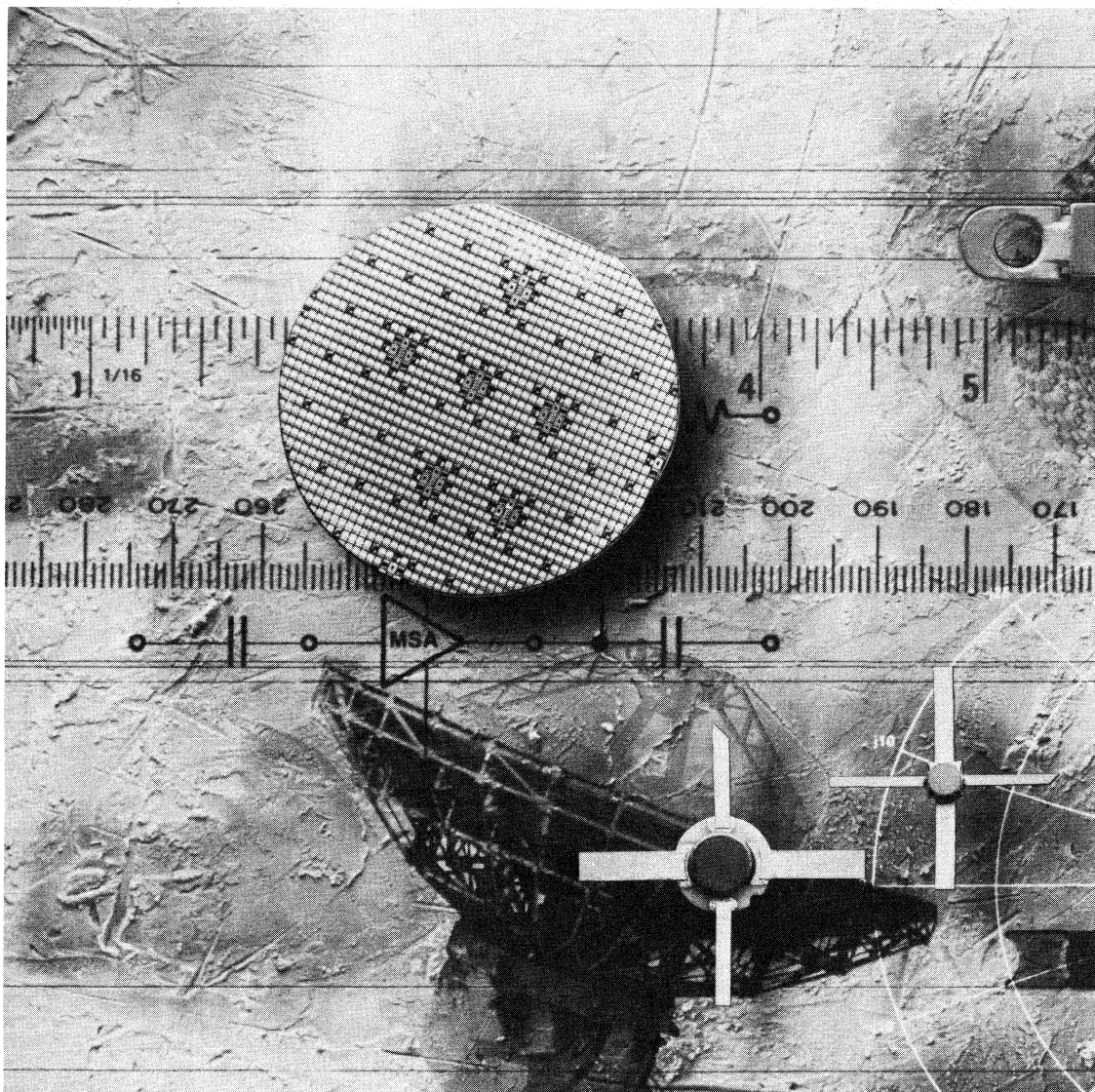

High Reliability Screening

INTRODUCTION	10-2
SILICON BIPOLAR TRANSISTORS	10-3
GALLIUM ARSENIDE FETs	10-4
MODAMP™ SILICON MMICs	10-5

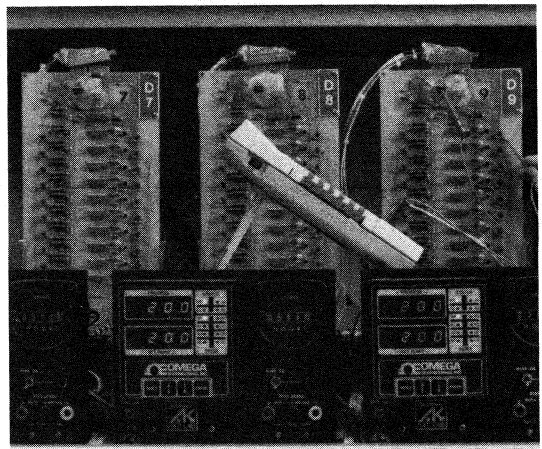
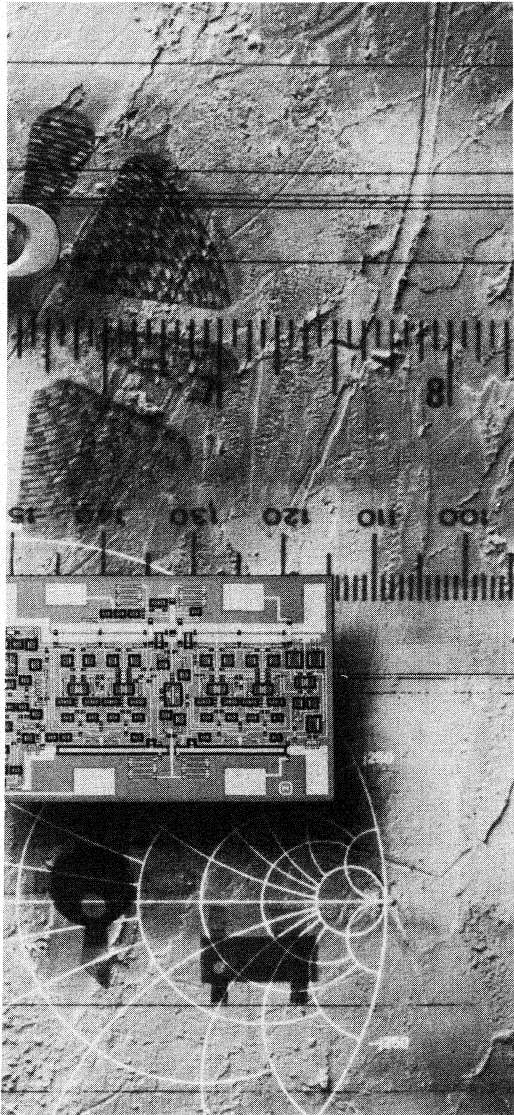

INTRODUCTION

High reliability is inherent in all Avantek semiconductor products since all wafers are processed to the same exacting standard regardless of whether the end use is for commercial, industrial, military or space applications. Avantek's successful involvement in high reliability programs in both military and space oriented markets is a result of screening (testing) these "standard" wafers to higher (more stringent) standards, thus

allowing them to satisfy the most demanding customer requirements. Material traceability to individual wafer and lot is fully maintained through documentation at each step of the screening process.

Avantek has full in-house screening capability. Some examples of the equipment used are shown in the photographs below.



State-of-the-art SEM (Scanning Electron Microscope) and semi-quantitative EDAX (Energy Dispersive Analysis of X-rays) system with EBIC (Electron Beam Induced Current) capabilities .

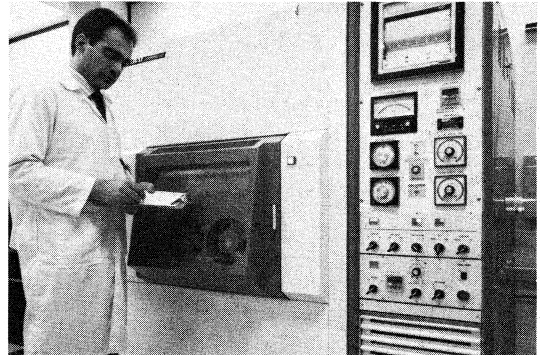

A 2 and 3 zone temperature cycling system with extra heaters and liquid nitrogen injection for quick recovery between -80°C and $+210^{\circ}\text{C}$.

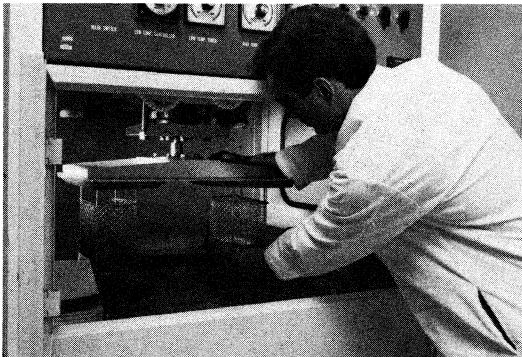

Fully automatic liquid-to-liquid thermal shock testing from -80°C to $+210^{\circ}\text{C}$ which simultaneously cycles two different lots through different thermal cycles.

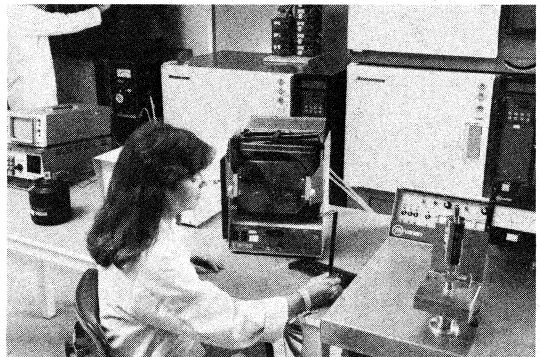

A Particle Impact Noise Detector, hermeticity testing stations, high ($+320^{\circ}\text{C}$) and super-high ($+500^{\circ}\text{C}$) temperature ovens, and a pure nitrogen environment oven.

Reliability Screening:

The Microwave Semiconductor Group offers the following levels of reliability screening on the standard silicon products presented in this catalog:

AK-S series screened devices (both discrete transistors and integrated circuits) are intended for space and other applications where high reliability screening is absolutely essential.

AK-TXV and **AK-TX** series devices are discrete transistors processed to screening requirements as applicable to non-space reliability environments.

AK-B and **AK-C** series devices are integrated circuits processed to screening requirements as applicable to non-space reliability environments.

Avantek's recommended Quality Assurance Test plans for semiconductor devices are detailed in the tables and flow charts which follow.

TABLE 1
AVANTEK PRECONDITIONING AND SCREENING—
PACKAGED SILICON BIPOLAR TRANSISTORS¹

TEST	MIL-STD-750 ¹ METHOD	CONDITION	AK-TX	AK-TXV	AK-S ³
1. Precap Visual Inspection	2072	AK specification AP-100604	—	100%	100%
2. Electrical Tests (Avantek Option) ²	—		100%	100%	100%
3. Stabilization Bake ⁴	1032	24 hrs.	100% ⁴	100% ⁴	100%
4. Temperature Cycling ⁵	1051	Cond. C 20 cycles min; -65°C to 175°C	100% ⁵	100% ⁵	100%
5. Constant Acceleration	2006	20K G's; Y1 plane	100%	100%	100%
6. Particle Impact Noise Detection	2052	Cond. A or B	—	—	100%
7. Hermetic Seal Tests —Fine —Gross	1071 1071	Cond. H Cond. C	100% 100%	100% 100%	100% 100%
8. Serialization	—		—	100%	100%
9. Interim Electrical Tests ²	—	hFE, ICBO	100%	100%	100%
10. High Temperature Reverse Bias	1039	Cond. A, 48 hrs; T _A = 150°C; V _{CB} = 80% BV _{CB0}	—	100% ³	100%
11. Interim Electrical Tests ² a) Per device data sheet b) Delta measurements	—	DC ΔhFE = ±25% ΔICBO = ±100% or ±50 nA, which is greater	100% — —	100% — —	100% 100% 100%
12. Power Burn-In ⁶	1039	Cond. B; T _j = 150°C	160 hrs.	160 hrs.	240 hrs.
13. Final Electrical Tests ² a) Per device data sheet b) Delta measurements	—	DC and RF ΔhFE = ±25% ΔICBO = ±100% or ±50 nA, which is greater	100% — —	100% 100% 100%	100% 100% 100%
14. Lot Acceptance (PDA) 10%	—	Interim/Final electrical and delta	Applies ⁷	Applies	Applies
15. Group A Temperature Tests	—	ICBO at T _{HIGH} = +150°C hFE at T _{LOW} = -55°C	—	116/0	116/0
16. Hermetic Seal Tests —Fine —Gross	1071 1071	Cond. H Cond. C	— —	— —	100% 100%
17. Radiography	2076		—	—	100%
18. External Visual Examination	2071		100%	100%	100%

NOTES:

1. Per Table II of MIL-S-19500 and the individual test methods of MIL-STD-750 to the extent specified herein.
2. Limit depends upon value specified in the applicable data sheet.
3. Not performed on micro-X package.
4. For micro-X package, T_A = 150°C.
5. For micro-X package, cond. F (20 cycles, min., -65°C to 150°C) applies.
6. The ambient temperature chosen is dependent upon P_{DC} and the associated thermal resistance.
7. Delta limits not applicable to AK-TX.

PART NUMBER ORDERING INFORMATION: (example using AT-00535/AT-00570)

HRT-00535TX; AK-TX Series screening
HRT-00570TXV; AK-TXV Series screening
HRT-00570S; AK-S Series screening

TABLE 2
AVANTEK PRECONDITIONING AND SCREENING—
PACKAGED DISCRETE GaAs FETs¹

TEST	MIL-STD-750 ¹ METHOD	CONDITION	AK-TX ²	AK-TXV	AK-S ³
1. Precap Visual Inspection	2072	AK specification AP-100604	—	100%	100%
2. Electrical Tests (Avantek Option) ⁴	—		100%	100%	100%
3. Stabilization Bake ⁵	1032	24 hrs; T _A = +175°C	100% ⁵	100% ⁵	100%
4. Temperature Cycling ⁶	1051	Cond. C 20 cycles min; -65°C to 175°C	100% ⁶	100% ⁶	100%
5. Constant Acceleration	2006	20K G's; Y1 plane	100%	100%	100%
6. Particle Impact Noise Detection	2052	Cond. A or B	—	—	100%
7. Hermetic Seal Tests —Fine —Gross	1071 1071	Cond. H Cond. C	100% 100%	100% 100%	100% 100%
8. Serialization	—		—	100%	100%
9. Interim Electrical Tests ⁴	—	IdSS, Vp, gm	100%	100%	100%
10. High Temperature Reverse Bias	1039	Cond. A, 48 hrs; T _A = 150°C; V _{GS} = 80% BV _{GSO}	—	100% ³	100%
11. Interim Electrical Tests ⁴ a) Per device data sheet b) Delta measurements	—	DC ΔIdSS = ±15% Δgm = ±15% ΔVp = ±15%	100% — — —	100% — — —	100% 100% 100% 100%
12. Power Burn-In ⁷	1039	Cond. B; T _{ch} = 150°C	160 hrs.	160 hrs.	240 hrs.
13. Final Electrical Tests ⁴ a) Per device data sheet b) Delta measurements	—	DC and RF ΔIdSS = ±15% Δgm = ±15% ΔVp = ±15%	100% — — —	100% 100% 100% 100%	100% 100% 100% 100%
14. Lot Acceptance (PDA) 10%	—	Interim/Final electrical and delta	Applies ⁸	Applies	Applies
15. Group A Temperature Tests	—	IGSS at T _{HIGH} = +150°C IDSS at T _{LOW} = -55°C	—	116/0	116/0
16. Hermetic Seal Tests —Fine —Gross	1071 1071	Cond. H Cond. C	— —	— —	100% 100%
17. Radiography	2076		—	—	100%
18. External Visual Examination	2071		100%	100%	100%

NOTES:

- Per Table II of MIL-S-19500 and the individual test methods of MIL-STD-750 to the extent specified herein.
- The GaAs FET micro-X package is epoxy sealed.
- Not performed on micro-X package.
- Limit depends upon value specified in the applicable data sheet.
- For micro-X package, T_A = 150°C.
- For micro-X package, cond. F (20 cycles, min., -65°C to 150°C) applies.
- The ambient temperature chosen is dependent upon P_{DC} and the associated thermal resistance.
- Delta limits not applicable to AK-TX.

PART NUMBER ORDERING INFORMATION: (example using ATF-26835/ATF-26150)

HRT-26835TX; AK-TX Series screening
HRT-26150TXV; AK-TXV Series screening
HRT-26150S; AK-S Series screening

TABLE 3
AVANTEK PRECONDITIONING AND SCREENING—
PACKAGED MODAMP™ SILICON MMIC's¹

TEST	MIL-STD-883 ¹ METHOD	CONDITION	AK-C	AK-B	AK-S ³
1. Precap Visual Inspection	2010	AK specification AP-100604	—	100%	100%
2. Electrical Tests (Avantek Option) ²	—		100%	100%	100%
3. Stabilization Bake	1008	Cond. C 24 hrs.; T _A = 150°C	100%	100%	100%
4. Temperature Cycling	1010	Cond. C 20 cycles min; -65°C to 150°C	100%	100%	100%
5. Constant Acceleration	2001	Cond. E 30K G's; Y1 plane	100%	100%	100%
6. Particle Impact Noise Detection	2020	Cond. A	—	—	100%
7. Hermetic Seal Tests —Fine —Gross	1014 1014	Cond. A Cond. C	100% 100%	100% 100%	100% 100%
8. Serialization	—		—	100%	100%
9. Interim Electrical Tests ²	—	G _p , ΔG _p ⁴	100%	100%	100%
10. Power Burn-In ⁵	1015	T _j = +150°C	160 hrs.	160 hrs.	240 hrs.
11. Final Electrical Tests ²	—	G _p , ΔG _p ⁴	100%	100%	100%
12. Lot Acceptance (PDA) 10%	—	Interim/Final electrical	Applies	Applies	Applies
13. Group A Temperature Tests	—	G _p , ΔG _p ⁴ T _{HIGH} = +125°C T _{LOW} = -55°C	—	116/0	116/0
14. Hermetic Seal Tests —Fine —Gross	1014 1014	Cond. A or B Cond. C	— —	— —	100% 100%
15. Radiography	2012	Two views	—	—	100%
16. External Visual Examination	2009		100%	100%	100%

NOTES:

1. Per the individual test method of MIL-STD-883 only to the extent specified herein.
2. Limit depends upon value specified in the applicable data sheet.
3. Not performed on micro-X package.
4. G_p is Power Gain (|S₂₁|²). ΔG_p is Gain Flatness.
5. The ambient temperature chosen is dependent upon P_{DC} and the associated thermal resistance.

PART NUMBER ORDERING INFORMATION: (example using MSA-0135/MSA-0170)

HRMA-0135C; AK-C Series screening
 HRMA-0170B; AK-B Series screening
 HRMA-0170S; AK-S Series screening

**FLOW DIAGRAM 1
PRODUCT ASSURANCE PROGRAM FOR PACKAGED MICROWAVE SILICON BIPOLAR TRANSISTORS**

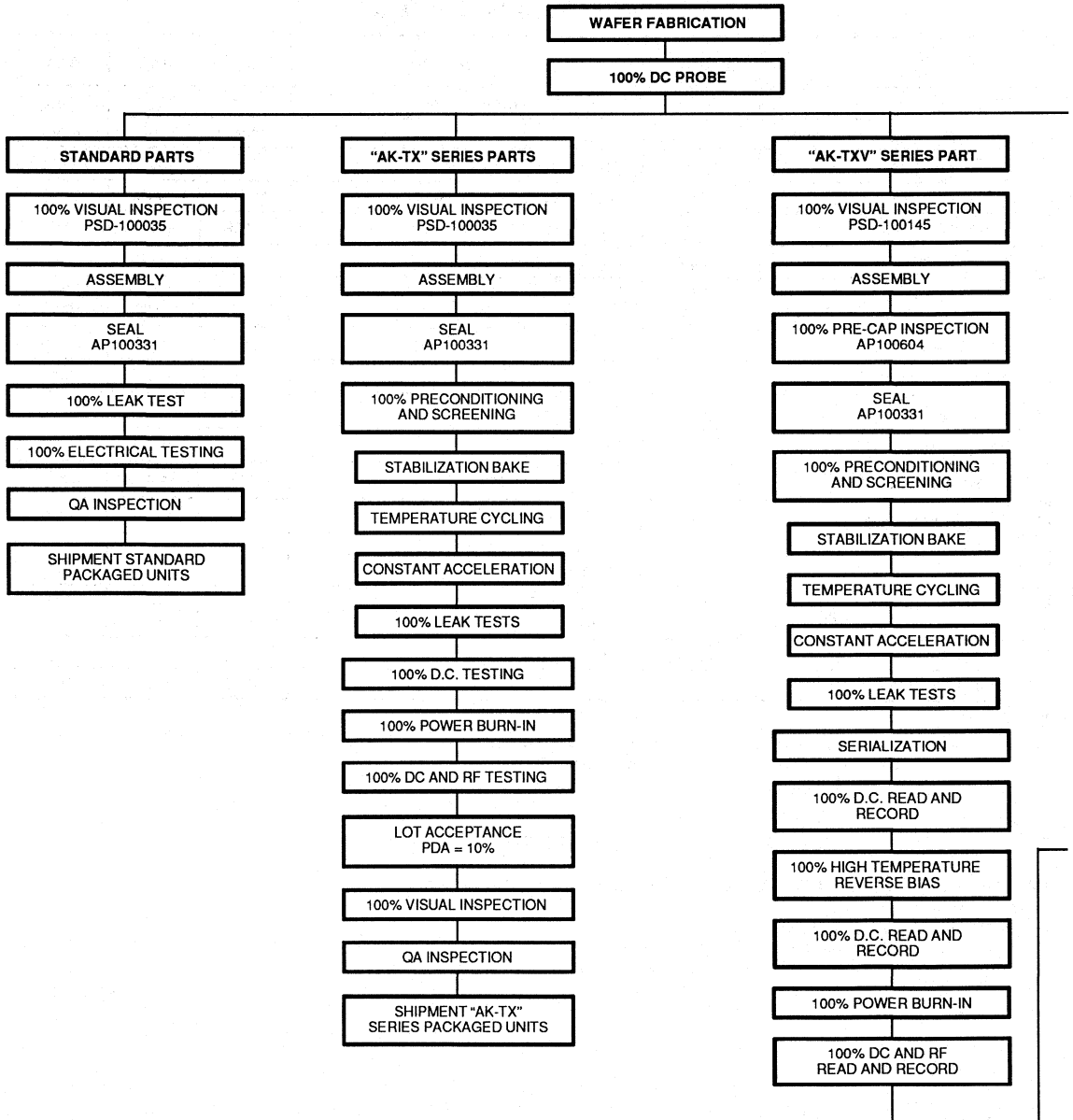

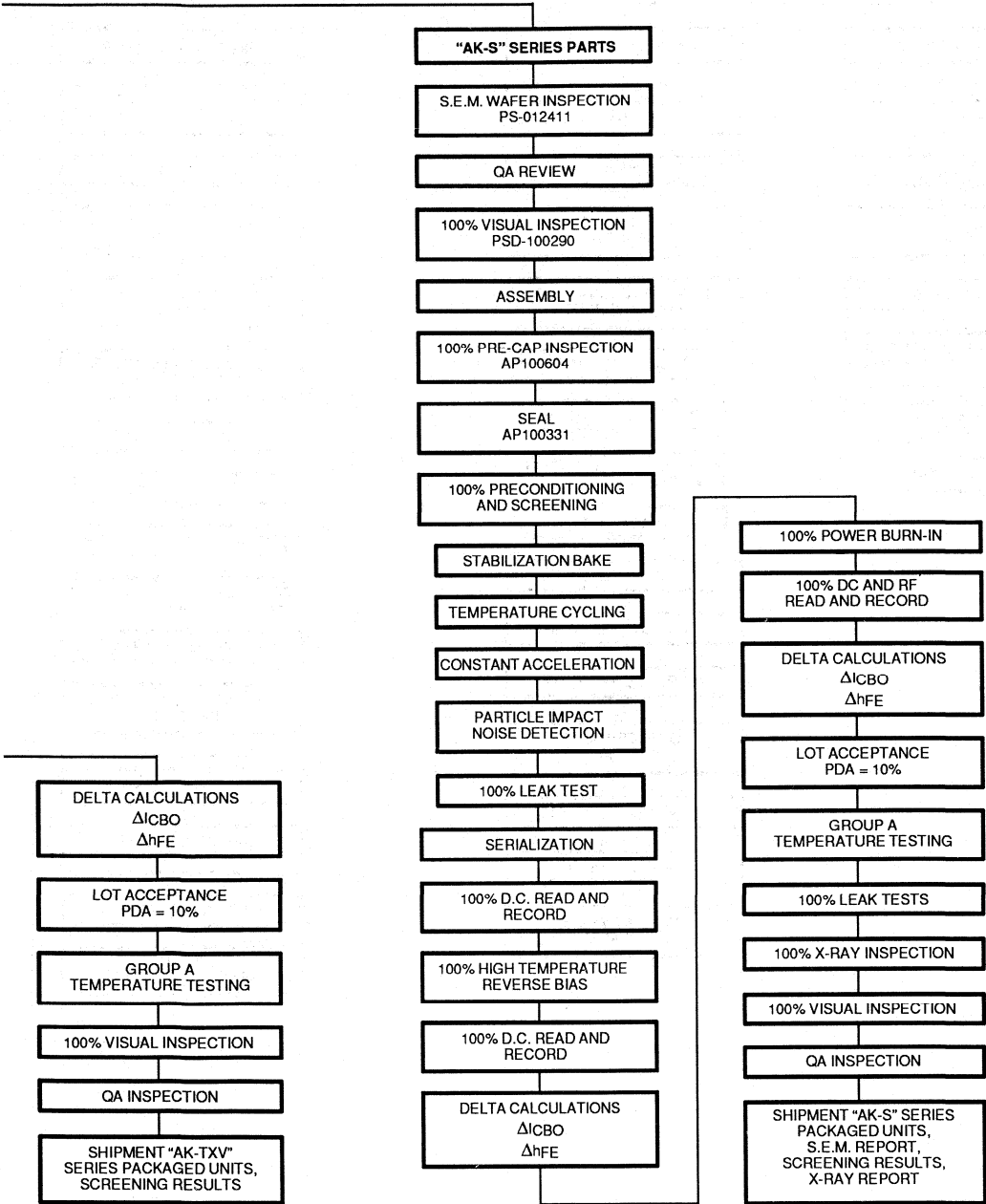

**FLOW DIAGRAM 2
QUALITY ASSURANCE PROGRAM FOR PACKAGED MICROWAVE GALLIUM ARSENIDE FETs**

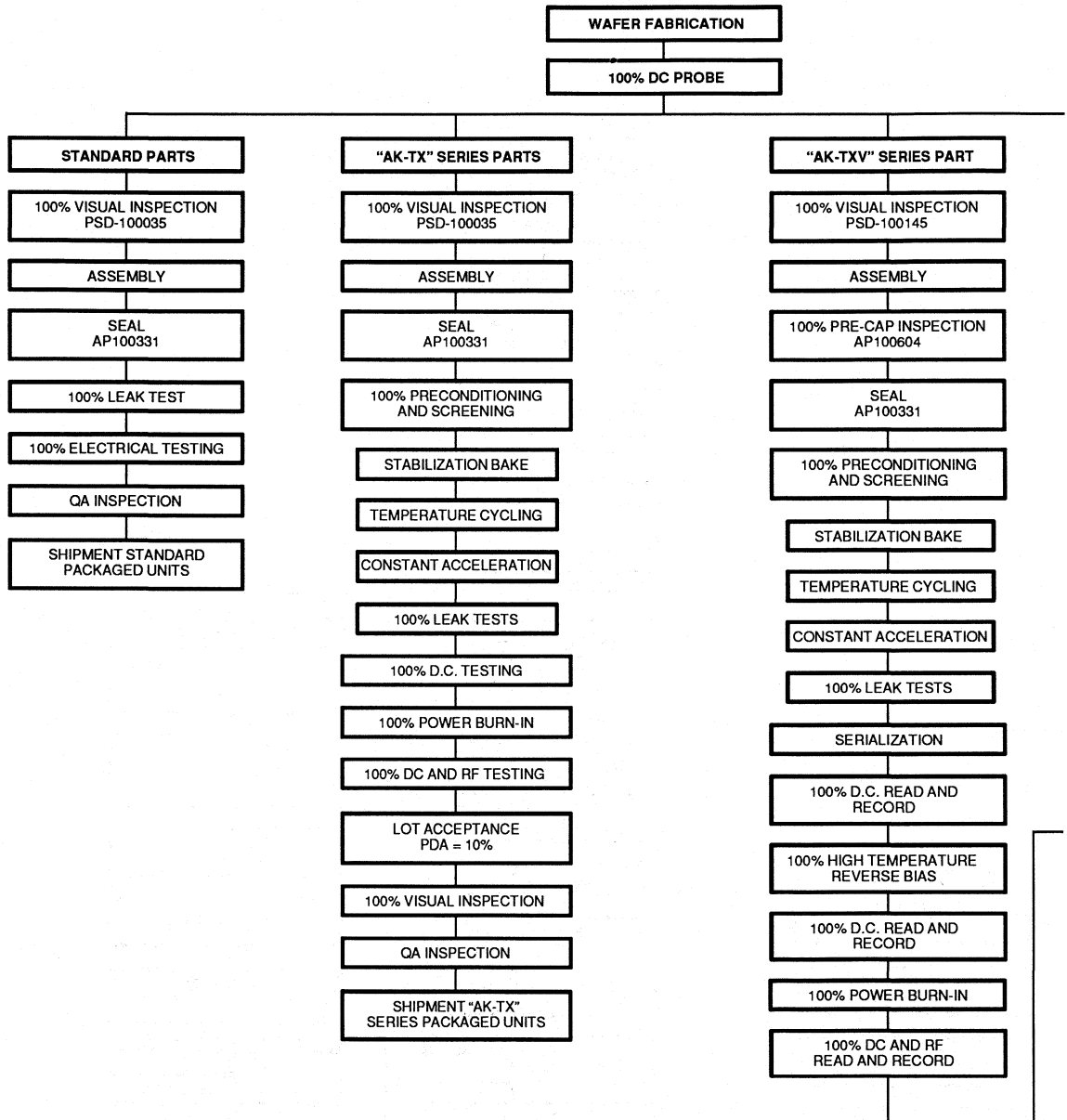

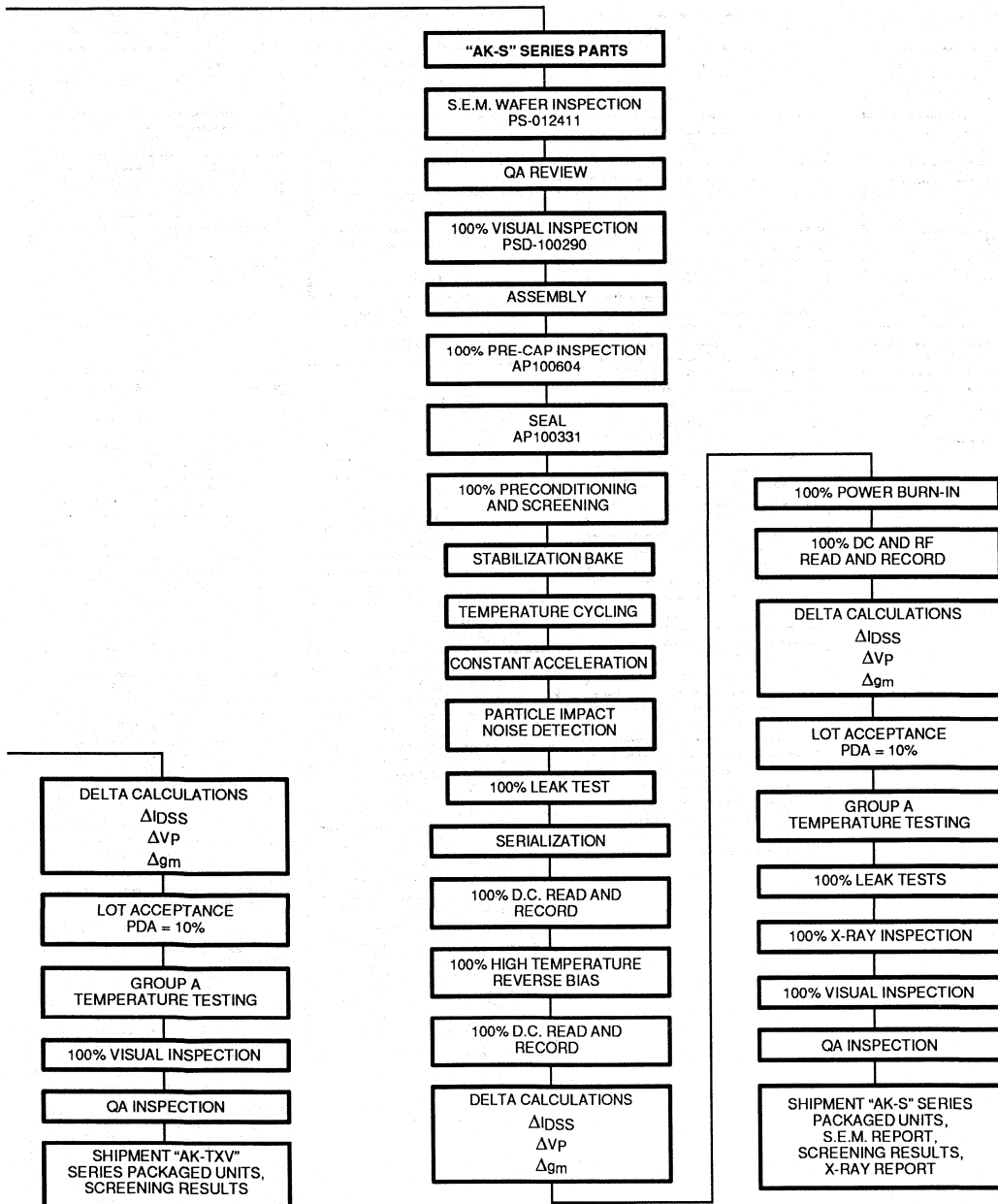

High Reliability Screening

FLOW DIAGRAM 3 PRODUCT ASSURANCE PROGRAM FOR PACKAGED MODAMP™ SILICON MMICs

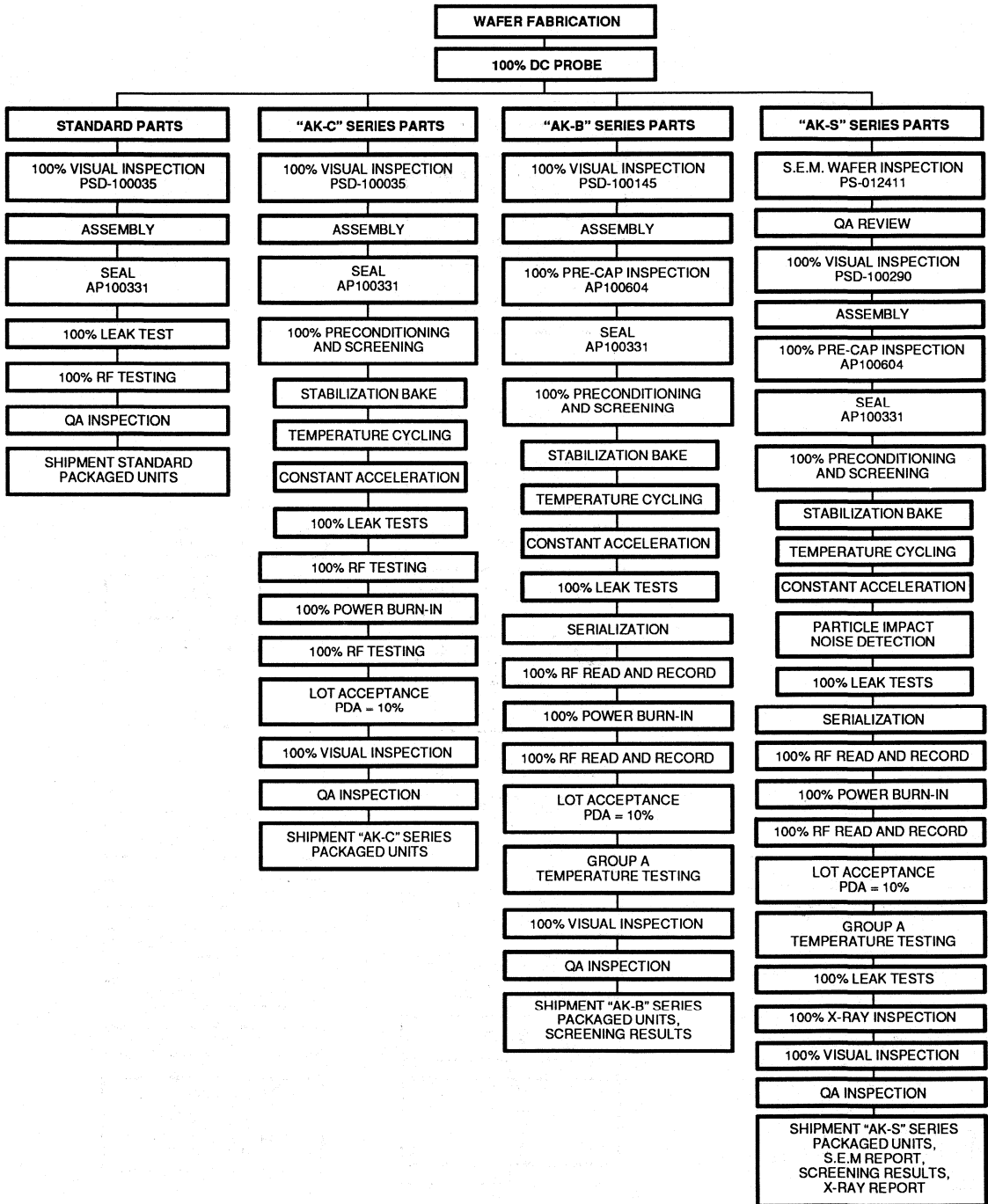



This page is intentionally blank.



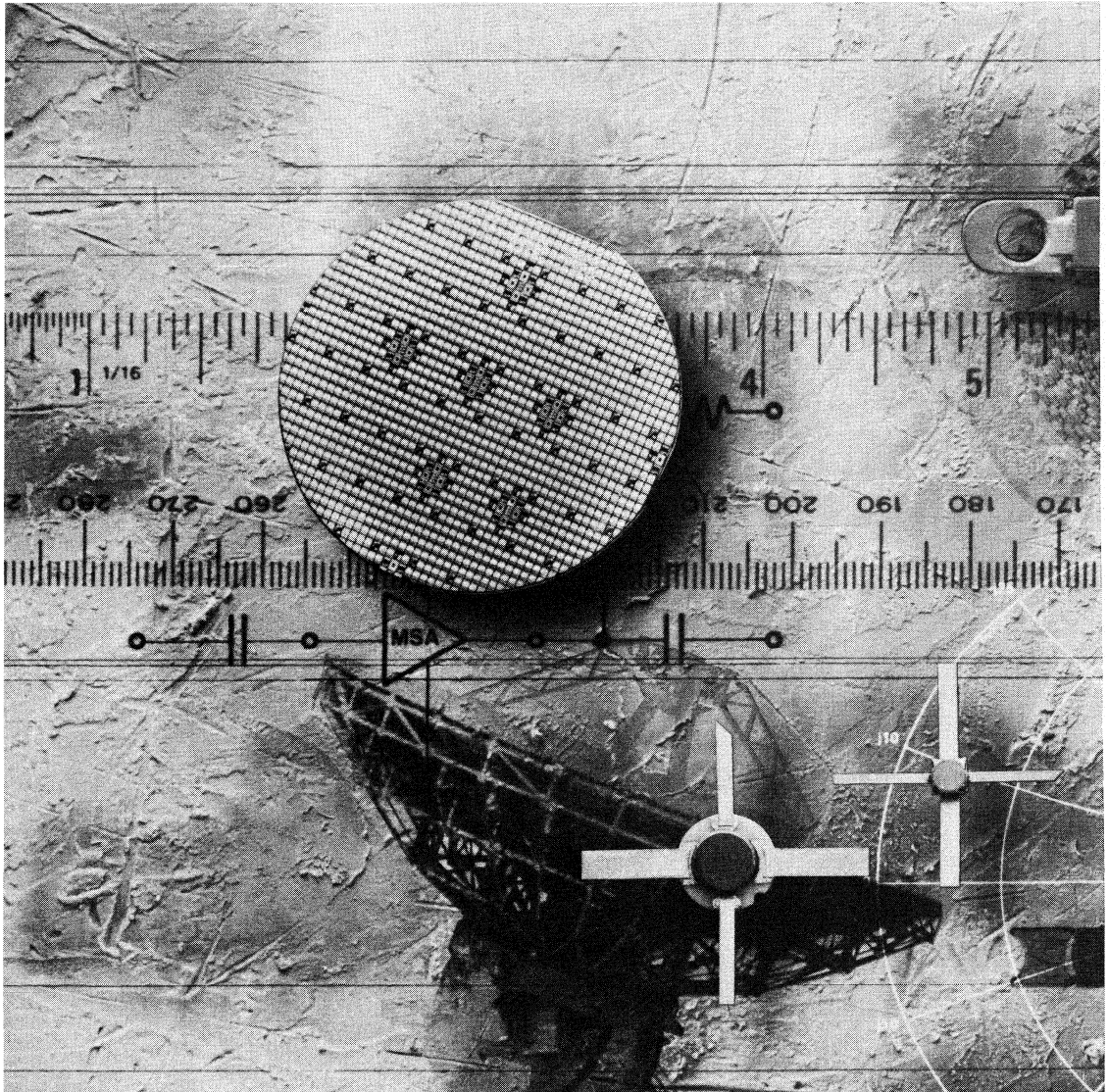

Quality Assurance, Warranty and Ordering Information

QUALITY PROGRAM	11-2
STANDARD TERMS AND CONDITIONS	11-3
ORDERING INFORMATION	11-5

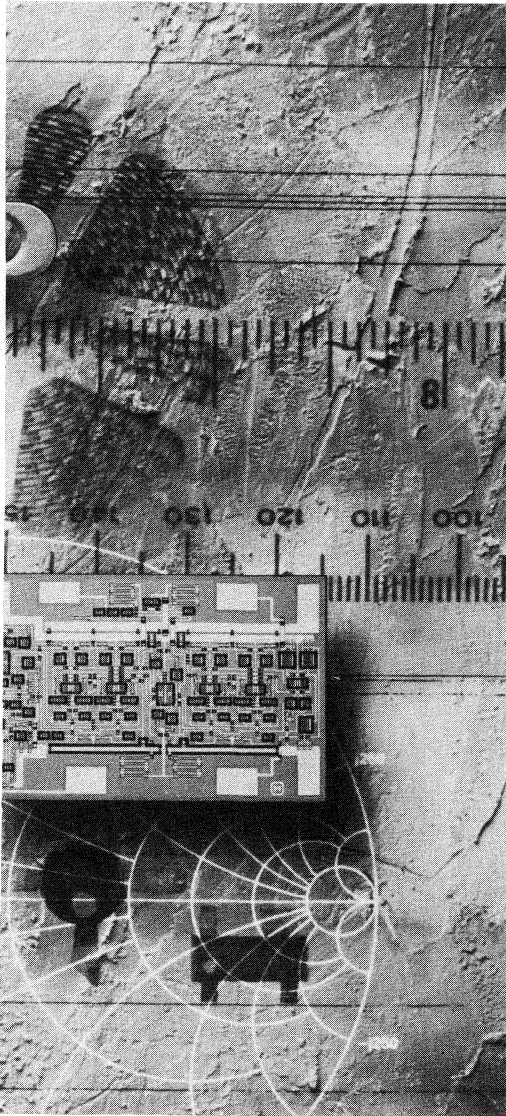

QUALITY PROGRAM

Avantek's Quality program is a single standard system which utilizes MIL-Q-9858A as the controlling document. The Quality Department maintains its independence from the operation it is overseeing by reporting to a separate division. The crucial communication link is provided via "dotted line" reporting.

A Quality Engineer (QE) is assigned to either a product line or specific customer depending on the size and complexity of the program. The QE is then responsible for approval of all quality-related activities within that program. His or her duties include, but are not limited to, review of customer request for quotations; review of customer documentation; approval of internal manufacturing-related documentations, including changes thereto; participation in material review and failure analysis boards; internal quality audits.

Vendor performance is monitored at all Avantek locations by the Incoming Inspection Department. The IID's responsibili-

ties include the maintenance of the vendor performance report, vendor surveys, corrective action, and incoming inspection with related objective verifications.

In-process and final inspection verification gates are established to provide timely information to manufacturing for performance measurements.

Reliability engineering provides product qualification data and analysis as well as expertise for purposes of failure analysis, and participates in corrective action responses.

In-house environmental capabilities include: centrifuge, shock, temperature shock/cycle, burn-in, acceleration, seal (gross and fine), and PIND.

The corporate internal calibration facility is equipped to provide full repair and calibration to MIL-STD-45662. Approved suppliers provide additional back-up calibration support beyond the in-house microwave capabilities.

STANDARD TERMS AND CONDITIONS**Microwave Components and Semiconductor Products**

Avantek, Inc. (Seller) submits quotations and receives and accepts orders subject to the following standard Terms and Conditions only.

proprietary data unless such data is separately defined, priced, and listed.

1. GENERAL CONDITIONS

- a) No understanding, promise, or representation, and no waiver, alteration or modification of any of the provisions stated, shall be binding upon Seller unless, accepted in writing by Seller.
- b) All orders are subject to credit approval and final acceptance by Seller's management at its California manufacturing sites.
- c) Award acknowledgment subject to these terms will be provided by a copy of the avantek Customer Sales Order (CSO) form.

- c) Prices exclude direct charges for special tooling or special test equipment unless separately defined, priced, and listed.

6. SALES OR SIMILAR TAXES

Unless otherwise stated, quoted prices do not include sales, use, excise or similar taxes nor export or import fees. Such taxes and fees will be borne by the Buyer.

2. DELIVERY

Unless otherwise specifically provided, delivery of the equipment shall be made F.O.B shipping point at which time the title and risk of loss shall pass to the Buyer. Seller shall not be liable for delays in delivery or in performance, or failure to manufacture due to causes beyond its reasonable control (force majeure).

7. PAYMENT TERMS

- a) Terms of payment are net 30 days after date of invoice, unless otherwise specified on the invoice.
- b) If shipments are delayed by the Buyer, payments shall be come due and payable on the date when Seller is prepared to make shipment.
- c) Goods held for the Buyer beyond a reasonable period, shall be at the risk of the Buyer and subject to warehouse charges.
- d) Seller reserves the right to require payment in advance and otherwise modify credit terms.

3. PACKING, MARKING AND SHIPPING

Goods shall be packed, marked and shipped using good commercial practices for protection and shipment. Enhanced service will be separately specified and an additional charge will be made to meet the Buyer's prescribed requirements.

8. WARRANTY

Seller warrants to the Buyer that all Seller goods (equipment and component parts) when sold are free from defects in materials and workmanship under normal use and service for a period of one year from the date of shipment, as evidenced by Seller's or its agent's packing list or transportation receipt. Seller's obligation under this warranty shall be limited to the repair or replacement of goods, at Seller's option, which Seller's examination shall disclose to its satisfaction to be defective. In no event shall Seller's liability for any breach of warranty exceed the net selling price of the defective goods. No person, including any dealer, agent or representative of Seller any other liability on its behalf.

4. SUBSTITUTIONS

Minor performance variations, as mutually agreed by the Buyer and Seller, will not be deemed to constitute failures to comply with specification requirements or constitute defects in materials or workmanship. Seller reserves the right to discontinue manufacture of goods and change specifications without prior notice, provided the performance of goods manufactured by Seller are neither affected adversely nor reduced below any contract specifications. Seller also reserves the right to make product improvements without any obligation or responsibility to incorporate such changes in goods previously manufactured or delivered.

Seller has no obligation or responsibility for goods which have been repaired or altered by other than Seller's employees.

5. PRICING

- a) Seller reserves the right to revise and announce new prices for the goods covered in quotations. Seller will honor the old prices if an order is received prior to revision of those prices, or prior to the expiration of a valid quotation outstanding at the time of the price change. Subsequent orders for the same goods are subject to the revised or newly-announced prices. Unit prices are applicable only to the specified quantity and are subject to revision if the quantity is changed.
- b) Quoted prices exclude technical data rights or computer software rights and existing or prospective

THIS WARRANTY IS THE ONLY WARRANTY MADE BY SELLER AND IS EXPRESSLY IN LIEU OF ALL OTHER WARRANTIES EXPRESSED OR IMPLIED, AND WARRANTIES OF MERCHANTABILITY AND FITNESS FOR ANY PARTICULAR PURPOSE ARE SPECIFICALLY EXCLUDED.

9. WARRANTY CLAIM PROCEDURES

Defective goods must be returned, transportation charges prepaid, to Seller for correction. Seller will pay return transportation charges for warranty repair. Upon redelivery of goods corrected under this warranty, the repaired or replaced portions shall be subject to this warranty for a period of 90 days or until expiration of the original warranty, whichever is later. All claims of failed or

Standard Terms and Conditions

defective goods must be in writing and received by the Seller within the specified warranty period. Seller will provide Buyer a return authorization number as authority to return the goods and for use in monitoring repair status.

Repair or replacement of defective goods will be at Seller's discretion and for the Buyer's account when the cause of failure is determined by Seller's examination to be misuse, mishandling or abnormal conditions of operation. In such event a firm price quotation for correction of the goods may be submitted to the Buyer. No repair or replacement work will be initiated prior to receipt of the Buyer's written authorization to proceed and approval of price, except as may be necessary to complete Seller's examination of the goods. If returned goods are determined not to be defective or if the Buyer elects not to authorize correction at its expense of goods not covered by this warranty, the Seller may charge a reasonable amount for such evaluation. Any amounts due Seller under these conditions will be subject to the same payment terms as the original sale. The Buyer will not recover from Seller by offset, deduction or otherwise, the price of any goods returned to Seller under this warranty.

10. LIMITATION OF LIABILITY

Seller's liability on any claim of any kind, whether in contract or in tort including negligence, for any loss or damage arising from, connected with, or resulting from this contract (or quotation), or from the performance or breach thereof, or from the design, manufacture, sale, delivery, installation, inspection, operation or use of any equipment covered by or furnished under this contract, shall in no case exceed the purchase price of the goods which give rise to the claim.

In no event, whether as a result of breach of contract or warranty or alleged negligence, shall Seller or its employees, agents, suppliers, or contractors be liable for special, incidental, exemplary, or consequential damages including, but not limited to, loss of profits or revenue, loss of use of the goods or any associated equipment, cost of capital, cost of substitute equipment, facilities or services, downtime costs, or claims of customers of the Buyer for such damages.

11. CANCELLATION

- a) The Buyer may cancel this order only upon written notice sixty (60) days prior to shipment, and upon payment to Seller of any reasonable cancellation charges.
- b) Order which are cancelled prior to shipment, if standard items, are subject to a 15% restocking charge for those items already in production or in finished goods inventory awaiting shipment to Buyer.
- c) Orders which are cancelled prior to shipment, if those items are "special" or "custom" items designed or modified to the Buyer's specifications, are essentially non-cancellable for that portion in production or in finished goods inventory awaiting shipment to the Buyer, and are subject to full recovery costs.

- d.) Orders which are cancelled after shipment to the Buyer, whether standard or special, remain the property of the Buyer.

12. PAYMENT AND COPYRIGHT INDEMNITY

- a) Seller agrees to defend at its expense any suits against the Buyer based upon a claim that any goods furnished hereunder directly infringe on a U.S. patent or copyright and to pay costs and damages finally awarded in any such suit provided that Seller is notified promptly in writing of the suit and at Seller's request and its expense is given control of said suit and all requested assistance for defense of same if the use or sale of goods furnished hereunder is enjoined as a result of such suit. Seller at its option and at no expense to the Buyer may obtain for the Buyer the right to use and sell said goods or shall substitute equivalent goods acceptable to Buyer and extend this indemnity thereof, or for goods other than semiconductor devices may accept the goods returned and reimburse the Buyer the purchase price therefore less a reasonable charge for wear and tear. This indemnity does not extend to any suit based upon any infringement or alleged infringement of any patent or copyright by the combination of any goods furnished by Seller with other elements nor does it extend to any goods of the Buyer's design or formula. The foregoing states the entire liability of Seller for patent or copyright infringement.
- b) The sale of the goods furnished hereunder does not convey any license by implication, estoppel or otherwise under any proprietary or patent rights of Seller covering combinations of these goods with other elements. In no event shall Seller be liable for incidental or consequential damages arising from infringement or alleged infringement of patents or copyrights.

13. GOVERNMENT CONTRACT CONDITIONS

If the Buyer's purchase order contains a U.S. Government contract number and orders products to be used in the performance of said contract those clauses of applicable U.S. Government procurement regulations directed by Federal Statute to be included in U.S. Government subcontracts shall be incorporated herein by this reference.

14. APPLICABLE LAW

The terms of quotations and any resultant orders shall be governed by and interpreted in accordance with the laws of the State of California.

15. MINIMUM ORDERS

For factory direct orders Avantek requires a minimum purchase of \$250.00. Contact distributors for smaller purchases.

HOW TO ORDER

For pricing information or to place an order, please contact any Avantek field sales office, sales representative or distributor listed at the back of this Data Book.

MINIMUM ORDERS

For factory direct orders Avantek requires a minimum purchase of \$250.00. Contact distributors for smaller purchases.

This page is intentionally blank.

Regional Sales Offices
EASTERN

Avantek, Inc.
Suite N-165
10005 Old Columbia Road
Columbia, MD 21046
(301) 381-2600

CENTRAL

Avantek, Inc.
Countryside Executive Center
1226 W. Northwest Highway
Palatine, IL 60087
(708) 358-8963

WESTERN

Avantek, Inc.
Suite 325
4165 Thousand Oaks Blvd.
Westlake Village, CA 91362
(805) 373-3870

EUROPE

Avantek, Ltd.
Frimley Business Park, Unit 6
Frimley, Camberley
Surrey GU15 5SG
United Kingdom
(44) 276-685753

Direct Sales Offices
NORTHERN CALIFORNIA

Avantek, Inc.
481 Cottonwood Drive
Milpitas, CA 95035-7492
(408) 954-0311

COLORADO

Avantek, Inc.
5690 DTC Blvd. Suite 130
Englewood, CO 80111
(303) 741-5757

FLORIDA

Avantek, Inc.
1645 Honey Bear Lane
Dunedin, FL 34698
(813) 787-3218

GEORGIA

Avantek, Inc.
3581 West Hampton Drive
Marietta, GA 30064
(404) 421-9007

Avantek Inc.
102 Shanan Court
Warner Robins, GA 31088
(912) 923-9989

INDIANA

Avantek, Inc.
8227 Constitution Drive
Fort Wayne, IN 46804
(219) 432-4965

KANSAS

Avantek, Inc.
Suite 122
10,000 W. 75th Street
Shawnee Mission, KS 66204
(913) 677-3716

MASSACHUSETTS

Avantek, Inc.
128 Wheeler Rd.
Third Floor
Burlington, MA 01803
(617) 272 7875

NEW JERSEY

Avantek, Inc.
611 Lamanna Drive
River Vale, NJ 07675
(201) 573-8534

NEW YORK

Avantek, Inc.
Suite 102
200 Parkway Drive South
Hauppauge, NY 11788
(516) 864-1054

PENNSYLVANIA

Avantek, Inc.
Suite 200
997 Old Eagle School Road
Wayne, PA 19087
(215) 254-9440

TEXAS

Avantek, Inc.
Woodcreek Plaza, Suite 180
101 W. Renner Road
Richardson, TX 75080
(214) 437-5694

* Effective November 11, 1989 - Prior to that use area code 312

**Avantek Worldwide
Distributors**
Domestic Distributors
NORTHWEST

**CALIFORNIA (Northern), IDAHO,
MONTANA, NEVADA (Northern),
OREGON, WASHINGTON,
WYOMING**

Penstock, Inc.
520 Mercury Drive
Sunnyvale, CA 94086-4018
(408) 730-0300 (No. Calif.)

Penstock, Inc.
10800 NE 8th Street, Suite 800
Bellevue, WA 98004
(206) 454-2371

SOUTHWEST

**ARIZONA, CALIFORNIA
(Southern),
NEW MEXICO, NEVADA
(Southern),**

TEXAS (El Paso area)

Sertek, Inc.
5356 Sterling Center Drive
Westlake Village, CA 91361
(818) 707-2872

Sertek, Inc.
1046 N. Tustin, Suite "I"
Orange, CA 92667
(714) 997-7311 or 7314
(619) 224-6911 (San Diego)

Sertek, Inc.
2111 East Broadway Road., Suite 5
Tempe, AZ 85282
(602) 894-9405

COLORADO, UTAH

Sertek, Inc.
5356 Sterling Center Drive
Westlake Village, CA 91361
(800) 334-7127

MIDWEST

**ILLINOIS, INDIANA, IOWA,
KANSAS, KENTUCKY, MICHIGAN,
MISSOURI, MINNESOTA,
NEBRASKA, NORTH and SOUTH
DAKOTA, OHIO,**

PENNSYLVANIA (Western),

WISCONSIN

Penstock Midwest
Countryside Executive Ctr., Suite 504
1250 W. Northwest Highway
Palatine, IL 60087
(312) 934-3700
(317) 784-3870 (Indiana)

CENTRAL

**ARKANSAS, LOUISIANA
(West of the Mississippi River),
OKLAHOMA, TEXAS, (Except
El Paso area)**

Thorson Distributing Company
4445 Alpha Road #109
Dallas, TX 75244
(214) 233-5744 (Dallas)
(512) 345-1985 (Austin)
(713) 558-8205 (Houston)

NORTHEAST

**NEW ENGLAND STATES
NEW YORK (Upstate)**

Sickles Distribution Sales
175 Bedford St., Suite 12
Lexington, MA 02173
(617) 862-5100

NEW JERSEY,

**NEW YORK (Metropolitan),
PENNSYLVANIA (Central and
Eastern)**

Penstock East
124B Little Falls Road
Fairfield, NJ 07006
(201) 808-1414

Penstock East
2010 Maple Shade Rd.
Ardmore, PA 19003
(201) 808-1414

**DISTRICT OF COLUMBIA,
MARYLAND, VIRGINIA,
WEST VIRGINIA,
SOUTH NEW JERSEY,
PENNSYLVANIA (Central and
Eastern)**

Applied Specialties, Inc.
10101 G. Bacon Drive
Beltsville, MD 20705
(301) 595-5393 (Metro D.C.)
(301) 792-2211 (Maryland)
(800) 638-8555

**DISTRICT OF COLUMBIA,
MARYLAND, VIRGINIA,
WEST VIRGINIA,
DELAWARE, METRO NEW YORK,
NORTHERN NEW JERSEY**

Nu Horizons
6000 New Horizons Blvd.
Amityville, NY 11701
(516) 226-6000

Nu Horizons
8975 Guilford Rd., Suite 120
Columbia, MD 21046
(301) 995-6330

Nu Horizons
39 US Route 46
Pinebrook, NJ 07058
(201) 882-8300

SOUTHEAST

**ALABAMA, FLORIDA, GEORGIA,
LOUISIANA (East of the
Mississippi River), MISSISSIPPI,
NORTH & SOUTH CAROLINA,
TENNESSEE**

Applied Specialties of Florida
8420 Ulmerton Road, Suite 406
Largo, FL 34641
(813) 530-7309
(800) 722-4599

Component Distributors, Inc.
11309 S. Memorial Parkway, Suite F
Huntsville, AL 35803
(205) 883-7501

Component Distributors, Inc.
312 So. Harbor City Boulevard, Suite 3
Melbourne, FL 32901
(407) 724-9910
(800) 558-2351

Component Distributors, Inc.
6264 Crooked Creek Road, Suite 2
Norcross, GA 30092
(404) 441-3320

Component Distributors, Inc.
5505 Creedmoor Road, Suite 206
Raleigh, NC 27612
(919) 787-7311

CANADA

Sertek, Inc.
5356 Sterling Center Drive
Westlake Village, CA 91361
(818) 707-2872

International Distributors

**ENGLAND, SCOTLAND,
IRELAND, WALES**

Wave Distribution LTD
Laser House
132/140 Goswell Road
London EC1V 7LE
England
(44) 1-251-5181

FINLAND

Vieltron OY
PO Box 5
SF-01651 Vantaa, Finland
(358) 90-848-788

**FRANCE, BELGIUM,
LUXEMBURG**

Sole Dimee
1, rue Leveleier Z.I. B.P. 25
91430 Igny, France
(33) 1-69-41-8282

ITALY

BFI Iboxsa SpA
18 Via Massena
20145 Milano, Italy
(39) 2-33100535

BFI Iboxsa SpA
Viale Paroli, 65
00197 Roma, Italy
(39-6) 88-70-191

JAPAN

Yamada Corporation
Shin-Aoyama Building East
1-1, 1-Chome Minamioyama
Minato-Ku, Tokyo 107 Japan
(81) 03-475-1121
Yamada Corporation
Higobashi Shimizu Building, 14F
1-3, 7-Chome Tosabori
Nishi-Ku, Osaka-Shi 550 Japan
(81) 6 449-1101

THE NETHERLANDS

BFI Iboxa B.V.
Brulsteingel 118
5232 AC s'Hertogenbosch
The Netherlands
(31) 0-73-408-256

NORWAY

Vieltron AS
PO Box 126-Alnabru
N-0614, Oslo 6 Norway
(47) 2-64-6870

SWEDEN,
DENMARK

Vieltron AB
P.O. Box 6063
Sorterargatan 2
S-162 06 Vallingby, Sweden
(46) 8-38-01-30

SWITZERLAND

Kontron Electronics AG
8010 Zurich
Bernerstrasse Sud 169
Switzerland
(41) 1-435-41-11

**WEST GERMANY, WEST
BERLIN, AUSTRIA)**

Kontron Physatek GmbH
Osakar-von-Miller Str 1
D-8057 Eching bei Munchen
West Germany
(49) 08165-77-388

**ALASKA,
CALIFORNIA (Northern),
OREGON, WASHINGTON,
IDAHO (Northwestern to
Boise)**

Cain-White & Company
105 Fremont Avenue, Suite D
Los Altos, CA 94022
(415) 948-6533

Cain-White/Northwest
10800 N.E. 8th St., Suite 800
Bellevue, WA 98004
(206) 462-2118

**ARIZONA, NEVADA,
NEW MEXICO, TEXAS
(EL PASO Area)**

Cain Technology
2111 E. Broadway Road, Suite 5
Tempe, AZ 85282
(602) 966-4322

**CALIFORNIA (Southern),
HAWAII**

Cain Technology
16525 Sherman Way, Unit C-4
Van Nuys, CA 91406
(818) 904-9392

Cain Technology
1046 N. Tustin, Suite I
Orange, CA 92667
(714) 997-7311

**MARYLAND, VIRGINIA,
WEST VIRGINIA
DISTRICT OF COLUMBIA**

Applied Engineering Consultants
10101 G. Bacon Drive
Beltsville, MD 20705
(301) 595-5393 (Metro D.C.)
(301) 792-2211 (Maryland)
(800) 638-8555 (All other)

**MINNESOTA,
NORTH & SOUTH DAKOTA
IOWA (Northern),
WISCONSIN (Except
Southeastern)**

Electronic Sales Agency, Inc.
8120 Penn Avenue South, Suite 160
Bloomington, MN 55431
(612) 884-8291

NEW ENGLAND STATES

R. J. Sickles Associates
175 Bedford Street, Suite 12
Lexington, MA 02173
(617) 862-5100

**NEW JERSEY (Northern)
NEW YORK (Metropolitan)**

Technical Marketing Associates
87 Lackawanna Avenue, Suite 1R
Totowa, NJ 07512-2309
(201) 812-0356

NEW YORK (Upstate)

Robtron
53 1/2 Jordan Street
Skaneateles, NY 13152
(315) 685-5731

CANADA

Allan Crawford Associates
5835 Coopers Avenue
Mississauga, ON L4Z 1Y2
(416) 890-2010

Allan Crawford Associates
6815 8th Street, N.E., Suite 135
Calgary, AB T2E 7H7
(403) 295-0822

Allan Crawford Associates
2625 Queensview Drive
Ottawa, ON K2B 8K2
(613) 596-9300

Allan Crawford Associates
6505 Trans Canada Hwy, Suite 300
St. Laurent, PQ H4T 1S3
(514) 747-7878

Allan Crawford Associates
410-212 Brooksbank Avenue
N. Vancouver, BC V7J 2C1
(604) 988-2195

**Avantek International
Sales Representatives****AUSTRALIA,**

Bendixsen Pty. Ltd.
10 Spring Gully Place
Wahroonga NSW 2076,
Australia
(02) 489-7775

FINLAND

Visitron OY
PO Box 5
SF-01651 Vantaa, Finland
(358) 90-848-788

**FRANCE, BELGIUM,
LUXEMBURG**

Scie Dimes
1, rue Lavoisier Z.I. B.P. 25
91430 Igny, France
(33) 1-69-41-8282

GERMANY

Kontron Phystech GmbH
Oskar-von-Miller Str 1
8057 Eching
West Germany
(49) 81665-77-376

Kontron Phystech GmbH
Maybachstr. 39a
7000 Stuttgart 30
West Germany
(49) 711-8917-137

Kontron Phystech GmbH
Markt 71
5205 St. Augustin 1
West Germany
(49) 2241-29046

Kontron Phystech GmbH
Königsreihe 2
2000 Hamburg 70
West Germany
(49) 40-68295-126

INDIA

Hinditron Services Pvt. Ltd.
42 Maharshi Karve Road
Churchgate
Bombay - 400 020
(91) 22-09-20/22-39-89

Hinditron Services Pvt. Ltd.
33/44 A, Rajmahal Vilas Extn.
8th Main Road
Bangalore - 560 080
(91) 363139/365734

Hinditron Services Pvt. Ltd.
Emerald House, 5th Floor
114, Sarojini Devi Road
Secunderabad - 500 003
(91) 82-11-17/82-37-51

ISRAEL

Gallium Electronics, Ltd.
P.O. Box 1379
5 Ussishkin Street
Ramat Hasharon, 47100 Israel
(972) 03-540-2242

ITALY

BFI Ibexsa SpA
18 Via Massena
20145 Milano, Italy
(39)2-33100535

BFI Ibexsa SpA
Viale Parioli, 63
00197 Roma, Italy
(39-6) 88-70-191

JAPAN

Yamada Corporation
Shin-Aoyama Building East
1-1, 1-Chome Minamioyama
Minato-Ku, Tokyo 107, Japan
(81) 03-475-1121

Yamada Corporation
Higobashi Shimizu Building 14F
1-3, 7-Chome Tosabori
Nishi-Ku, Osaka-Shi 550 Japan
(81) 6 449-1101

KOREA

Sangsoo Electronics Company
Kyungho Bldg., Suite 303
25-2, Yoido-Dong, Yungdeungpo-Ku
Seoul, Korea
(82) 2-780-5360-2

THE NETHERLANDS

BFI Ibexsa B.V.
Bruistensingel 118
5232 AC s'Herengenbosch
The Netherlands
(31) 0-73-408-256

NORWAY

Visitron AS
PO Box 126-Alnabru
N-0614, Oslo 6 Norway
(47) 2-64-6870

**PEOPLE'S REPUBLIC OF
CHINA, SINGAPORE,
HONG KONG, INDONESIA,
PAKISTAN, BANGLADESH,
THAILAND, MALAYSIA**

Esoon Enterprises, Inc.
6916 Stella Link Road
Houston, TX 77025
(713) 666-2538 or (713) 666-9135

SPAIN

BFI Electronica S.A.
Paseo Marques de Zafra, 38. Bis
28028 Madrid, Spain
(34) 91-255 95 03

SWEDEN, DENMARK

Visitron AB
P.O. Box 6063
Sorterargatan 2
S-162 06 Vallingby, Sweden
(46) 8-38-01-30

SWITZERLAND

Kontron Electronics AG
8010 Zurich
Bernerstrasse Sud 169
Switzerland
(41) 1-435-41-11

TAIWAN

Sertek, International, Inc.
3rd Floor, Section 2
135 Chien Kuo North Road
Taipei 10479, Taiwan R.O.C.
(886) 2-501-0055

YUGOSLAVIA

Belram S.A.
83 Avenue des Mimosas
1150 Brussels, Belgium
(32) 2-734-33-32



3175 Bowers Avenue
Santa Clara, California 95054-3292
Phone (408) 727-0700